

809
4

A
Complete Course
in
Canning



22101910795

BOOK
SELLERS
CATALOGUES
FREE

Handwritten text, partially visible at the top right corner.

Med

K21202

A COMPLETE COURSE IN CANNING



BEING A THOROUGH EXPOSITION OF THE BEST,
PRACTICAL METHODS OF HERMETICALLY SEAL-
ING CANNED FOODS, AND PRESERVING
FRUITS AND VEGETABLES.



Originally Republished from the serial articles appearing in

“THE CANNING TRADE”
The Canned Food Authority.

Revised Up to Date.

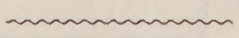

FOURTH EDITION.

Completely Revised 1919.

COPYRIGHT 1914 BY
THE CANNING TRADE
BALTIMORE, MD.

~~~~~  
COPYRIGHT 1919 BY  
THE CANNING TRADE  
BALTIMORE, MD.

| WELLCOME INSTITUTE<br>LIBRARY |          |
|-------------------------------|----------|
| Coll.                         | welMOmec |
| Call<br>No.                   |          |
|                               | WA       |
|                               |          |
|                               |          |
|                               |          |

From  
the Press  
of  
"The  
Canning  
Trade"



## DEDICATED

THE preservation of foods, whether in the canned state or known as jams, preserves, jellies, condiments or others, has developed wonderfully in the past quarter century, and particularly has the canning of foods. Back in those early days, when "A Complete Course in Canning" first made its appearance, it was the late W. L. Hinchman, Ph. G., who laid its foundations of times and procedure, just as he was the directing genius in untold numbers of plants which produce articles which now rank among the leaders in all markets. Hinchman was a font of knowledge in food preservation matters, which only those who sought its depths came to know and appreciate. A trained chemist and pharmacist, his knowledge of commercial food products was practical and at the disposal of any one in doubt. He did more to promote this industry than most men realize, and it is to pay him some slight tribute that this volume is dedicated to him.

He was not the sole author of the first edition of this work, but collaborated to a large extent in its production, and to a smaller degree in later revisions, but he is rightly entitled to consideration as one of the founders of the practical processes upon which the present great structure of the business has been built. And the world is coming to recognize this.

This latest revision sees the elimination of much of the earliest work, as must be in the march of progress, but the changes, made by our foremost food men, are improvements and not innovations as a rule. And this stands as a lasting testimonial to any man: That in principal he was right, though time enforces changes.

A. I. JUDGE.







# INTRODUCTION

Standing for a generation, as THE CANNING TRADE has stood, the representative journal of the canned food industry and all that that implies; having begun its existence when the business of hermetically sealing or preserving foods was itself in its infancy, and having been intimately associated with every movement of that great industry in its rapid advancement; fighting its battles at a time when the industry was weakest; suggesting the advantages of and actually forming the first Association of Cannerymen, and instrumental in the formation of every one since; known to all men in any way connected with the industry as the honest, fearless champion of the canned food packer, it is but natural that the requests for a reliable work, one that would be of practical use to all, in the factory itself, should come to THE CANNING TRADE.

These requests have come from every section and from men in every branch of the industry, covering every article handled by the packers. In the early years they were the natural outcome of the effort on the part of all in the industry to make a secret of the process, but for this reason it must not be supposed these requests came only from new parties wishing to go into the business. Men who had made a success packing certain articles wished to increase the number, and experience had taught them that a good beginning was half the battle won. These frequent requests compelled us to gather the desired information, and in seeking, naturally we chose the best obtainable. This was copied in a large book, and the frequent additions soon made the book practically complete. But not only were formulæ thus collected, but accounts of the varied experiences in different sections of the country with certain foods by the different packers, were kept in this record. And thus was compiled, little by little, an amount of information on the processing and preserving of foods, from the leading processors of the day, that without doubt had not its equal in the world. It afforded comparisons that were most instructive, one processor's method with another's, one way of treating a fruit or vegetable with another in vogue somewhere else, the effect a difference of seasons, whether wet or dry, had upon the time and results, all of which was from actual work in the process room, and not from theory.

As may be supposed, it took years to accumulate this mass of valuable information, and our object may be seen in the book we herewith present.

"A Complete Course in Canning" is not a copy of the records of the book above referred to; it was originally written by a man who had had a vast experience in canning, preserving, pickling, and in every branch of food preserving, not in one section, but in almost



every section of this country and Canada. But his work was compared and checked against this book and made to correspond with it.

This Fourth Edition has been completely revised by the leading recognized authorities of the industry, and is accordingly as reliable as conditions can make it.

Realizing that an immense amount of good could be done by giving straightforward, practical instructions, such as could be readily understood by all and used in the process room actually, THE CANNING TRADE undertook the publication in serial form of this work. Its original intention was to start with each article in the selection of the seed, the preparation of the ground, the cultivation of the growing crops, the harvesting of the same and their removal to the factory. But so eager were our readers for the pith of the story—the actual working formula in the process room—that we had to forego the first part of this, and content ourselves with the contracting for the crops, their removal to the factory, and then take them step by step through the factory, until we had seen them safely and neatly labeled and boxed ready for shipment. This is what the packers wanted, and this is what we gave them.

Our original intention was merely to treat canned foods in all their varieties, but in giving these we aroused a great desire for information upon the making of Jams and Jellies, Preserves, Catsups, Soups, Meats and Fish, Flavoring Extracts, Salad Dressings, and the like, and so these were added to the list and will be found in this volume.

The readers of this book will find the formula given are practical, ready for use; they have all been tried and used repeatedly by men who have made a success of the business, and there is but one reservation goes with them: **CONSIDERABLE COMMON SENSE MUST BE ADDED TO ALL FORMULA.** By this we mean that it is absolutely impossible to give one set time of process for all conditions and locations; that every change of temperature, altitude, difference in soil or fertilizer, a wet or dry season, and a hundred and one other causes may have an effect upon the process, and so **NO LARGE PACK OF GOODS SHOULD BE PUT UP UNTIL A TRIAL BATCH HAS FIRST BEEN MADE.** And not only at the beginning of the season, but frequently during the pack, in order to detect any changes.

If used judiciously, in this manner, these formula will be found satisfactory, differing possibly with different processors, as is natural, but worthy the high approval set upon them when they were published in serial form and in the three editions since published.

THE CANNING TRADE.

For list of Contents see back of book.



# THE CANNING INDUSTRY

It is now a little more than one hundred years since the French Government made a practical effort to give to the world in general the results of its endeavors to find a better and more wholesome method of preserving foods in a manner as nearly fresh as possible; and it must be admitted by all that we owe the origin of the canned food business, as it is at present, to the wisdom of the French Government, and that the Government of the First Republic.

About the year 1795, that is to say right at the height of the reign of terror in France, the French Government offered a prize of 12,000 francs for the best method of preserving fruits, vegetables and other elementary articles without pickling or dessication. The French Minister of the Interior, M. Montalivet, acting on the report of the Board of Arts and Manufacturers, granted to M. Nicholas Appert the reward of 12,000 francs. This award was made in 1810. The according of the award required the recipient to furnish the Government with a true and faithful copy in book form of his methods in full, for the benefit of the world in general, and M. Appert complied with this requirement before obtaining the money.

Whilst this is a French invention and not an accidental discovery, the developments of it during the past century have tended to make it peculiarly an American industry and success. But it is true today that we have no men in our midst, nor in the best factories in the world, that we are aware of, who can do what Appert did with foods. One test of this matter is the preservation of eggs in a fresh condition. To keep eggs in hermetically sealed vessels, through the application of heat, is of so delicate a nature that it must be possible when eggs are taken out of the vessel to make an omelet of them, which proves that they are of their original nature. Even "limed" eggs will not do this. And yet Appert had the time and method by which it could be done.

M. Appert was excellently equipped in the experience of life to accomplish what he undertook, and there were probably fifty years of experience in his dealings with the various lines of foods with which it was necessary for him to be acquainted, before he made public his method. He was in turn a pickler, a preserver, a wine maker, and we believe a confectioner, during the long years of his application and work. During all this time he was very poor. Any money he got was expended in further experiments, and while he lived to be over 90 years of age, we believe he died in comparative poverty in spite of the award obtained from the French Government and his attention to work.



The French Chambers, however, after his death, recognized the vast utility of his invention to mankind in general, and virtually placed his name among famous men by creating his son a Chevalier in the Legion of Honor in recognition of his services, and the family hold that honorable position to-day in France. The French Government also ordered a life-sized bust to be made of him, and we believe that has an honorable place in the office of the Minister of the Interior.

But the development of a century virtually changed the utensils and broadened the methods of Appert under the extension of demand which came through American business; and a view of his simple utensils and process room, so to call it, would provoke a smile to-day.

We believe it was in 1810 that an English tin-plate worker took out a patent in England for a vessel of tin plate for use in the preservation of hermetically sealed foods, and we mention the fact here in connection with the previous greater fact, because to-day the canning industry is as much dependent upon the can, and, in fact, has taken its commercial name "canning" from it, as the can-making industry is dependent upon the hermetically sealing business.

Under the title "A History of the Canning Industry by Its Most Prominent Men" THE CANNING TRADE published in January, 1914, a splendid and comprehensive history of the origin and development of this business in all lines and in all sections. It should be read in connection with this brief reference.

One thing, however, we would like to emphasize here, and that is that the French carefulness in everything they do, especially in regard to foods, would add vastly to the excellence and reputation of American canned foods, if it were but generally practiced. This excellence, the results mainly of patience, operates from the selection of the seed, or even the growing of the seed, to the affixing of the brass label for high-class trade; and the Government at Paris recognizes not only the sanitary advantages of this method but the commercial advantages that result from it, and is so careful with regard to the honest efforts of the French canners that it appoints Boards of Inquiry to investigate charges against methods in the canneries before condemning them from mere newspaper accusation. Thus in the matter of green peas, which is probably one of the largest of the French lines of canned foods, the investigating boards reported that a small amount of salts of copper was highly beneficial in a commercial sense and not injurious to the consumer; and under the French law packers are allowed to use a certain slight proportion of sulphate of copper upon green peas. It is this permission, not abused by the French packers, which gives to French peas the admitted superiority and pre-eminence they have throughout the world, and tends largely to continue the demand for French peas; but colored peas cannot now be imported, the United States Pure Food Law prohibiting their entry.

## A MARKET.

As the particular object of this work is to keep to the essentially practical questions and the solution of them, without any regard to whether the reasoning herein shall be satisfactory to promoter, packer or distributor, we will first take a glance at what is probably the most important question the packer has to consider—that is, where and how he will market his goods after he has put them up.

Now, the sale of canned foods, like everything else pertaining to the necessities of the human family, will depend upon the contiguity of the market; or, in other words, population. It might be necessary to stop here and consider the question of transportation costs of these goods; but it is very evident that the facilities of transportation in these modern days are, in America at any rate, in exact proportion to the extent of population. In other words, financial and stock matters always result in placing the means of transportation where there is population to justify the expense. The canning industry has therefore to thank the other lines of commerce and manufacture for this simplification of a great difficulty; but, in turn, this matter of established communication and transportation really governs the location of canning factories. There are, however, some peculiarities, geographical as well as commercial, in which the center of greatest population may be considered the governing factor. Thus the 39th degree of latitude is the median line of the westward progress of population in America, as demonstrated by recurring census for more than a century. Now this 39th degree of latitude runs about on a line of Baltimore, Indianapolis, Denver and somewhat north of Sacramento; in other words, through Maryland, Ohio, Indiana, Illinois, North Missouri, the dividing line of Kansas and Nebraska, Northern Colorado, Utah, Nevada and Northern California. We mention these States in the order in which they lie from East to West, because the increase of population, or what is known as the center of greatest population, has moved westward contiguous to this line at the rate of an average of 40 miles each ten years; and in the last census (1910) was to be found about 4 miles southeast of the town of Unionville, Monroe county, Indiana, which is about 30 miles south of Indianapolis. It is advancing, therefore, directly into the State of Illinois at present, and now is considered as having reached there. Along this isothermic line this increase of population may be relied upon to continue, and the importance of this knowledge will be appreciated in respect to the canning industry, when it is understood that this is the identical line of what may be known as the center of the tomato-packing region. The market for canned tomatoes essentially lies with the greatest population. Railroad transportation will always follow the same course. Therefore, the two important facts of distribution



and consumption are to be found along this line of the 39th parallel.

A further consideration in this respect was made clear when the Government, under the necessities caused by the world war, took over the operation of the railroads. One of the first evident alterations was an effort to stop cross-shipments, *i. e.*, the shipment of Illinois coal, for instance, into Ohio, and of Ohio coal into Illinois; the object being to increase local consumption and to decrease transportation. This principle will, most certainly, be applied to canned foods to an even greater extent, under the new conditions following the termination of the war. And it is economically right that it should be so; there is no economy in shipping Indiana tomatoes to Maryland, and Maryland tomatoes to Indiana or Illinois. Local demand will be filled by locally packed canned foods, and it should be, and only the surplus be distributed, and then only to nearest points of shortage. This must result in better profits, and because the cost of goods will be lower, increase consumption.

### TOMATOES.

Tomatoes are not, and never will be, a heavy Northern pack, because the season is too short to make them plentiful in production, and there is always danger of an abnormally early frost to destroy the vines in the middle of the season.

This marked condition would not prevail were it not that by keeping south of this line of the 39th degree, the reverse condition may be relied upon, and, therefore, it will not pay anyone to undertake to compete in northern latitude with tomato growers in a more congenial clime. It, therefore, follows that the man who wishes to be successful in packing tomatoes should consider these facts, but at the same time not overlook the corresponding important fact that to go below this line a great deal will take him into a section too far removed from population, too poorly equipped with transportation facilities, and, therefore, lacking the two first essentials in marketing his goods. This will show distinctly that a little consideration at least is necessary both to the would-be packer and the promoter in their intended operations; and a man must consider well and decide definitely as to whether he is going to make tomatoes the basis of his business to rely upon, or other staples.

### CORN.

By, in what may be considered, a strange and fortunate coincidence, corn appears to occupy an entirely different position in this geographical situation to what the tomato crop does. While corn can be grown successfully in the fields from the parallel of 35 degrees to that of 45 degrees, it does better and produces a sweeter article



in the northern section than it does in the warmer climate. Sugar corn appears under all circumstances to develop a finer quality of the article in the higher latitudes, and this is probably due to the influence of sudden growth and development from a short and hastened summer. Even in Maryland corn grown on the slopes of the western mountains and at the foot hills of the Blue Ridge is, in so far as sugar corn is concerned, a sweeter and better article than that grown in the lowlands near the sea. It is from this fact also that Maine has gotten its reputation for the quality of its sugar corn. Northern New York shares this excellent reputation; Illinois and Wisconsin are turning out very fine qualities of this article, increasing each year, and in the order of progression with time, we may expect to see Bismarck, Helena, and Portland, Oregon, or Olympia, Washington, vieing with Portland, Maine, in the quality of their canned sugar corn, although the Pacific cities last named and that location may suffer somewhat in quality from the moist effects of the Japan current.

The same remarks in respect to the location of tomato factories in the middle section will apply to the consideration of locating sugar corn factories in the northern sections. The median line which we first mentioned will at all times have the preference in the minds of practical men, because the three great requisites of the business come together there natuarlly, that is crops, population and transportation facilities. But it means more than this when further considered. Because of the facts we have recited it is reasonably certain that competition of prices will be more keen along this line of tomato factories, always more numerous than those of corn factories, and we would be willing to risk the assertion that fluctuations and speculations in canned tomatoes will always exceed that which will develop in corn. It is certain to be, and that which is certain is worth consideration.

### PEAS.

The third one of the great staples of the canned food industry, considering the vegetable essentially, is the green pea. The packing of this food has assumed very large proportions. In respect to this article the animus of the industry appears peculiar. When a new firm starts in an agricultural section to put up canned foods, the height of its ambition is generally bounded by a desire to pack tomatoes or corn, according to the latitude it is in; but it seems to be the fact that every canned food packer, after learning how to pack corn, gets the pea packing hornet in his bonnet, and will not be content till he packs peas. Nothing but the difficulty and the excessive care in packing good green peas has prevented the packing of this excellent article from having been greatly overdone. We witnessed years ago such a development of the packing of green peas that it looked as if the market would be swamped with the



amount; but that conservation of forces which seems to take care of all things in this world managed to prevent its being overdone. In the first place, at the outset of this rush to pack peas, because the packers did not give the right care to their work, not knowing what was necessary to be done to make good peas, a large quantity of the pack in some sections was sacrificed at such cheap rates that it considerably curtailed the pack of the following year. Then again the famous pea fly came around and the crop was blasted. For many years the packing of green peas was restricted to certain places on the Atlantic coast, especially Baltimore and its neighborhood, and to a small degree central New York State, but the early advent of the Chisholm pea beater permitted the packing of green peas at almost any section where tomatoes could be packed, and the later addition of the pea viners and separators made a large number of hands unnecessary in this special work. Green peas can be grown well and packed anywhere from the thirty-fifth to the forty-fifth degree of latitudes, but the location and character of the country wherein they are grown have very much to do with the quality of the peas. Recent experience has taught that if green peas are not planted in cold weather and before the warm spring changes commence, that the pea fly may develop beyond management, and further that what the peas need most in a growing condition is a moist, mild climate. It is for this reason that the growing and packing of green peas developed so largely in the Chesapeake region, and primarily around Baltimore because the need of many hands in both the field and canning factories required contiguity to a large city to get such a supply of labor in the days before they had machinery to do this work. Peas can be grown well and economically in the interior, even in a dry section, but the quality of the pea itself, the integral composition of the green pea varies with the soil and climate with which it is raised. In a dry climate, especially, where there is alkali water in the streams, where there is much lime in the soil, the peas will absorb too much lime, and though they seem to be young and tender, will swell more in processing, but not turn out so tender as those that come from a more moist climate and softer water. It is probable, therefore, that the fixed locations of great pea canning establishments will be the humid coasts of the oceans, both east and west, and upon the interior lands contiguous to the great lakes, and, perhaps, in the future in the sections where the United States Government may prosecute irrigation for a national benefit.

This is a matter which should be considered by every one proposing to make pea packing a considerable part of the business. The packing of peas, it will be found when we come to consider that

---

(NOTE—The above prediction was made nearly 20 years ago and is borne out to-day in the fact that the great pea-canning factories are located in the identical regions indicated.)



special article, requires more care than any other article in the vegetable list, and as our green peas have a competitor in the European article of French green peas of the very finest quality, it is essential that only the very best effort be directed to the production of this article.

Colorado and Utah have been packing very good peas for years, mainly on irrigated lands, and the volume of their packs has assumed fairly large proportions and is growing each year. In the last few years California has added peas to its long list of canned foods, and is gradually increasing the output until we may soon expect it to rank among the leaders in pea canning. The long season and varying climate make pea raising and canning a possibility over a longer season than other States enjoy.

It is not out of place here to remind all canners or intended canners that after the effects of the world war begin to pass off, competition from Europe, in canned foods, may be more intense than before. Canned foods came fully into recognition in all the countries at war, because the armies found themselves dependent upon them. Even during the war many nations opened up canneries to provide provisions for their armies, and the practice will grow. The many factories there produced goods on a small scale, as compared with ours, and mainly for export to America. They now see the great opportunities in this line and at home.

At the outbreak of the war in 1914 Belgium was ready to supply fine canned peas to America at lower prices than our canners could produce them, and shipments had actually reached New York. After restoration the intensive farmers of Belgium, Holland, France, Italy, Spain, not to mention Austria-Hungary and other countries, will be called upon to supply an ever-increasing number of commercial canneries, and the response will make our American farmers bestir themselves. There is undoubted evidence that canning will become a great industry in Europe, if not in the whole world.

In a general sense the canned food industry may be divided into classes of species, viz.: Fish, Fruits, Meats, Milk, Sauces, Soups and Vegetables.

Vegetables as used in this arrangement differentiate from fruits, which also belong to the vegetable kingdom. We have mentioned and discussed above the general question of the vegetable section, and we propose now to glance in the same way at what are known as the fruit sections of the United States and North America.

### FRUITS—APPLES.

Considering fruit in the important matters of quantity and public favor, we think it safe so say that apples hold the prime position. The apple to all other fruits appears to be as the rose to all

other flowers—the most universally known and the general favorite. In the canning industry the assertion can be made that the extent of the fresh apple crop in any season fixes the value of all other fruit crops, and in this respect it is of great importance to all fruit canners to watch closely the conditions of the apple crop and the quotations of apples throughout the season. Two things are steadily developing in the American apple business; one was, previous to the war, the increased annual call made upon this country by Europe for our apples, and the other is the steadily increasing demand for apples in gallon, or, as they must now be called, “No. 10” cans, for what are known as commercial purposes. These commercial purposes are mainly foreign shipment of this fruit in tin, the use of canned apples in the pie-making establishment, and in hotels and dining-rooms. The canning of apples has become almost a specialty in the industry, and, therefore, a location in what is known as an apple section would naturally cause a canning factory so located to regard apple canning as a possibility to an increase of their business or line. Such a factory, however, should be located as near as possible to the consuming market, that is, either towards the greater center of population, or the foreign exporting ports.

The principal apple sections of North America at present are: New York State, Ohio, the Missouri Valley, Pennsylvania, North Pacific Coast up towards Vancouver sound, and then the Tennessee, Virginia and the upper Mississippi Valley sections of the country; their importance being relatively about in the order given.

Canada is an important apple-growing section of North America, and England is an interested market for most of the surplus apples of the Dominion.

There are two classes of apples used by the canners. The summer apple which is usually too watery to keep when barreled, and, therefore, when the crop is large can be bought very low for canning purposes, and, of course, will keep indefinitely when tightly sealed; and the winter apple, coming in very many varieties and growers are steadily developing new ones.

The canned output of apples, according to the report made by the Government, under the authority of the Food Administration, amounted to 1,280,637 cases of all sizes, but it is to be remembered that the No. 10 can largely predominated.

## PEACHES.

Next to apples, peaches hold the position of quantity and favor among canned fruits. The great peach-growing sections of the United States are much more limited than are the apples. The season is shorter, for peaches must be secured while in their best condition, or they will spoil. There was a time when peaches were common every summer along the Atlantic coast as far as Maine;



but the orchards have died out more and more with the passage of time, disappearing from the northern sections and developing more or less in the South. It is within the memory of the living when New Jersey had many fine peach orchards; to-day it may be stated that it is not possible to successfully cultivate peaches in New Jersey, and the same deterioration and depletion is rapidly proceeding in the Maryland and Delaware Peninsula, which twenty-five years ago was considered the very paradise of the peach.

The great peach section of the Atlantic upon which the eastern locality has to depend is Georgia. In the interior of the country in the eastern half of the Mississippi Valley, peaches do not appear to be a crop that can be depended upon, as they have a full crop only about once in six or seven years, on account of the uncertainty of the climate. Ohio and Kentucky should have great peach orchards, but when the wintry blizzards blow unobstructed from the great prairie lands of the Northwest, they bring such low temperatures with them that the peach crop is more often a failure than a success, and as these trees are sub-tropical in their nature, the tree itself suffers from these untimely visitations.

Michigan, however, although more northern, is more fortunate in this respect, because it is comfortably cuddled in the embraces of the Great Lakes, and gets protection from the ameliorating influences of the very waters which surround her. Michigan, therefore, is a prosperous northern peach region, and this peculiar influence of the Great Lakes affects the contiguous lands easterly along the borders of the Great Lakes, so that New York State for a few miles within the southern margin of the lakes is quite an important fruit growing section. The Missouri Valley, especially in Kansas and Arkansas, is also a considerable peach growing section, but a large quantity of the peaches native there are of the Spanish variety, which do not find the same favor as their lighter brethren. When, however, we get down into Texas we reach another section where the peach is at its best, and the eastern portion of Texas is becoming more and more a great peach growing section, and when population increases sufficiently in the southwest region and transportation facilities are increased, Texas will compete with California in this and other fruit growing. But of all sections of the United States, California is the paradise of fruit and of peaches especially.

The peach and its cousin, the apricot, grow in immense quantities with almost perennial conditions in the golden State of California. For many years the East has almost depended upon California for a large portion of its canned fruit, the dependence being mutual. The extraordinary difference of value upon which freight has to be paid by rail has to a large extent precluded the shipment of any but high priced, and, therefore, the finest quality used in tin. So that peach packing has divided itself into two classes: High

price, fine quality of fruit from California, and low priced, ordinary or common quality from the Atlantic coast. Therefore, it can be reckoned that a man who proposes to can fruit in California should devote himself to only high-grade goods and not try to compete with the standard, seconds and pies of the Eastern section, as railway tariffs will keep him out of the populous market.

The ultimate opening of the Panama Canal may change this condition materially, and permit California to supply immense amounts of "pie" peaches to the Eastern market, a consideration of doubtful benefit to California.

### SMALL FRUITS.

Pears and plums furnish a considerable item in the annual pack of fruits, but they are only minor factors in the fruit line, though the demand is increasing. It is strange to say that common pears are becoming so plentiful throughout the United States that there is seldom money in packing them, but Bartlett pears are never in sufficient supply, and are always an article worthy of consideration, and may be depended upon to pay well if canned as a fine, high-class product.

Small fruits of all kinds hold a peculiar position in the canning industry. Twenty-five years ago there used to be a great public demand for them every year as canned fruit, but there came a wave of lack of appreciation over the people, and demand for them almost died out.

California still furnishes the world with a considerable quantity of the better class, and strawberries and raspberries in heavy syrup as high-class goods are more in request of the better people and the hotels, and are being more largely packed wherever grown.

Washington State, particularly in the vicinity of the Puyallup Valley, has come strongly to the front in recent years as a grower of raspberries, blackberries, and Loganberries, the latter one of the famous Burbank creations, and which gained almost instant public approval because of the size and fine, distinctive flavor.

What is true of these goods is also true of cherries, and the decadence in the packing of cherries has been due more to the result of rain on the crop in season and the consequent loss of dependence upon this fruit in season. In any section where cherries can be depended upon as an annual crop, it will pay to can them in good styles, and there is even a steady sort of market among pie makers for the cheaper qualities.

### SUNDRIES.

There is one article which we scarcely know how to catalogue in the list of fruits and vegetables, for while it is certainly a vegetable, it is used almost exclusively as a fruit by those who purchase



it in tin. We mean pumpkin and squash. It may be classed entirely almost as a Northern article, its habitat being in the Northern belt, and naturally the demand for it is in the same section, but the article itself keeps so well in its natural state, almost entirely through the winter, that the energetic housekeeper seems to prefer crooknecks to the canned article. All the country eats pumpkin pies, and for such purposes there is a considerable pack put up each year. The preparation of it in the canning by means of machinery makes such a fine custard pumpkin of it that housekeepers prefer it to a hard and crusty pumpkin.

In the South the sweet potato does duty in nearly the same way as pumpkin in the North, and there are hotels and public providers throughout the land which must at times be able to supply sweet potatoes at any time of the year.

We think this general review of the section and crops of fruits and vegetables will enable almost any one desiring or proposing to go into the canning business to inform himself reasonably as to the prospects of any location for a canning factory, and the line of goods that he could most profitably handle in the selected section, and to accomplish this is our purpose in these statements.

In establishing a cannery it is, of course, presumed in the first instance that the parties contemplating the erection of a factory have duly considered the possibility and probability of growing, or being able to purchase at equitable prices, sufficient products of the varieties it is desired to pack in the immediate vicinity of the place, sufficiently large quantities to run the factory at its full capacity for a reasonable period of time.

### POSSIBILITY OF ACREAGE.

In considering this question of the supply of raw stock for canning, it is not sufficient to be merely assured that the land in the section in question will produce the particular vegetable or fruit; but it should be conclusively proven that the crops so produced are well adapted to canning—that is, that the texture of the fruit or vegetable will stand the process of canning and turn out well. Much trouble has been experienced by old packers through the fact that growers brought in the one vegetable, grown in widely separated sections, though all within a small radius of the factory, and raised according to the individual grower's ideas, but which were found when "processed" to turn out greatly different in quality. One section of the country may grow a vegetable that may be very fine in appearance, but which may be too watery, too soft, or too fibrous, and consequently too tough, and so on.

*The best is not too good for canning, and this should be borne in mind, if success is to be expected.*

If this point be satisfactorily passed, the next consideration to look to is a sufficiency of supply. As the packer is necessarily restricted in the prices he can pay for his crops, he should be careful to see that there are enough growers willing to undertake the growing of the crops in question to such an extent that the factory will be kept steadily employed during the season. Plain, open dealing with the grower will be found the best policy in this case, stating just what he may expect from his crop. If the grower is led to believe his fortune will be made in the first year out of any crop, by painting the picture too glowingly to him, he will look for it, and not finding it, is liable to give trouble another year. The profits of any crop going to a canning factory are small, but compare favorably with any of his other crops in the average year. Having dealt honestly with him, insist upon a strict return of the same character from him.



For Machinery and Supplies consult the Advertisers in the back of this Book.



## SEED REQUIRED TO PLANT AN ACRE OF GROUND

The following list, giving the amount of each variety of seed required to plant an acre of ground, is based upon an average, but the amount given is generally considered to be sufficient, so that a thorough distribution of seed may be expected from the amount specified:

| Kind of Seed.                                  | Quantity<br>Per Acre. | Kind of Seed.                                  | Quantity<br>Per Acre. |
|------------------------------------------------|-----------------------|------------------------------------------------|-----------------------|
| Asparagus, 1 oz. to 200 plants.....            | 5 lbs.                | Melon, Water, 4 oz. to 100 hills....           | 5 lbs.                |
| Asparagus Roots, 1 oz. to 1000 plants          | 7250                  | Mustard .....                                  | 30 lbs.               |
| Barley, broadcast.....                         | 2½ bu.                | Nasturtium, 2 ozs. to 100 ft.....              | 15 lbs.               |
| Beans, Dwarf, qt. to 100 ft.....               | 1 bu.                 | Okra, 1 oz. to 100 ft. of drill.....           | 8 lbs.                |
| Beans, Pole, 1 pt. to 100 hills.....           | ½ bu.                 | Oats, broadcast .....                          | 2½ bu.                |
| Beets, Garden, 1 oz. to 50 ft.....             | 6 lbs.                | Onion Seed, ½ oz. to 100 ft. drill..           | 5 lbs.                |
| Beet, Mangel, 1 oz. to 100 ft.....             | 6 lbs.                | Onion Seed, for sets .....                     | 60 lbs.               |
| Brussel Sprouts, 1 oz. to 5000 plants          | 2 ozs.                | Onion Sets, qt. to 40 ft. of drill....         | 8 bu.                 |
| Broom Corn, in hills.....                      | 8 lbs.                | Parsnip, ½ oz. to 100 ft. of drill... 5 lbs.   |                       |
| Buckwheat, broadcast .....                     | ½ bu.                 | Parsley, ½ oz. to 100 ft. of drill... 3 lbs.   |                       |
| Cabbage, 1 oz. to 4000 plants.....             | ¼ lb.                 | Peas, Garden, Smooth, 1 pint to 100            |                       |
| Cane Seed, for fodder.....                     | 70 lbs.               | ft. of drill.....                              | 1 bu.                 |
| Carrot, 1 oz. to 100 ft. of drill....          | 3 lbs.                | Peas, Garden, Wrinkled, 1 pint to              |                       |
| Cauliflower, 1 oz. to 3000 plants....          | 5 ozs.                | 100 ft. of drill.....                          | 2 bu.                 |
| Celery, 1 oz. to 10,000 plants.....            | ½ lb.                 | Peas, Sugar Marrowfats in drills... 1¼ bu.     |                       |
| Chicory, 1 oz. to 100 feet of drill... 4 lbs.  |                       | Peas, Field or Canada, broadcast... 2 bu.      |                       |
| Clover, Alsike and White.....                  | 8 lbs.                | Pepper, 1 oz. to 1500 plants.....              | 6 ozs.                |
| Clover, Alfalfa or Lucerne.....                | 20 lbs.               | Potatoes, cut tubers, in drills.....           | 10 bu.                |
| Clover, Crimson or Scarlet.....                | 15 lbs.               | Pumpkin, 4 ozs. to 100 hills.....              | 4 lbs.                |
| Clover, Mammoth Red, Medium Red                | 12 lbs.               | Radish, 1 oz. to 100 ft. of drill....          | 8 lbs.                |
| Collards, 1 oz. to 5000 plants.....            | ¼ lb.                 | Radish, broadcast .....                        | 12 lbs.               |
| Corn, in hills, field, shelled.....            | 8 qts.                | Rape .....                                     | 3 lbs.                |
| Corn, for fodder or soiling.....               | 2½ bu.                | Rhubarb, 1 oz. of seed to 1000 plants          | ....                  |
| Corn, Sweet, 1 pint to 100 hills....           | 6 qts.                | Rye, broadcast .....                           | 1½ bu.                |
| Corn, Rice Pop Corn (shelled)....              | 2 qts.                | Sage, in drills.....                           | 5 lbs.                |
| Corn, Salad, 3 oz. to 100 ft.....              | 6 lbs.                | Salsify, 1 oz. to 50 ft. of drill.....         | 8 lbs.                |
| Cress, ¾ oz. to 100 ft. of drill....           | 12 lbs.               | Sorghum .....                                  | 12 lbs.               |
| Cucumber, 1 oz. to 50 hills.....               | 2 lbs.                | Spinach, in drills, 1 oz. to 100 ft... 25 lbs. |                       |
| Dill, 1-3 of oz. to 100 ft. of drill... 5 lbs. |                       | Summer Savory .....                            | ¾ lb.                 |
| Egg Plant, 1 oz. to 2000 plants....            | 4 ozs.                | Sunflower .....                                | 8 lbs.                |
| Endive, ¼ oz. to 100 feet.....                 | 4½ lbs.               | Squash, Bush, 1 oz. to 100 hills....           | 4 lbs.                |
| Flax Seed, broadcast.....                      | ½ bu.                 | Squash, Running Varieties, 8 oz. to            |                       |
| Grass, Kentucky Blue.....                      | 28 lbs.               | 100 hills .....                                | 3 lbs.                |
| Grass, Canadian Blue.....                      | 30 lbs.               | Tomato Seed, 1 oz. to 3500 plants..            | 4 ozs.                |
| Grass, Red Top fancy recleaned....             | 10 lbs.               | Tobacco, 1 oz. to 5000 plants.....             | 1 oz.                 |
| Grass, Timothy .....                           | ¼ bu.                 | Turnip, 1 oz. to 200 ft. of drill....          | 2 lbs.                |
| Grass, Orchard .....                           | 2 bu.                 | Turnip, broadcast .....                        | 2½ lbs.               |
| Grasses, Perennial Rye, Italian Rye,           |                       | Vetches, broadcast .....                       | 2 bu.                 |
| Wood Meadow .....                              | 2 bu.                 | Wheat, broadcast .....                         | 2 bu.                 |
| Grass, German .....                            | 1 bu.                 | Wheat, in drills.....                          | 1 bu.                 |
| Grass, Hungarian Millet.....                   | 1 bu.                 | Clover, } Together { 6 lbs. Clover             |                       |
| Grass, Rhode Island Bent.....                  | 3 bu.                 | Red Top, } for { 8 lbs. Timothy                |                       |
| Hemp .....                                     | ½ bu.                 | Timothy, } One Acre { 6 lbs. Red Top           |                       |
| Horse Radish Roots.....                        | 15,000                | Clover, } For One { 6 lbs. Clover              |                       |
| Kale, 1 oz. to 5000 plants.....                | 5 lbs.                | Timothy, } Acre { 10 lbs. Timothy              |                       |
| Kohl Rabi, ½ oz. to 100 feet.....              | 4 lbs.                | Red Top, } For One { 6 lbs. Red Top            |                       |
| Leek, ½ oz. to 100 ft. of drill.....           | 4 lbs.                | Timothy, } Acre { 8 lbs. Timothy               |                       |
| Lettuce, 1 oz. to 3000 plants.....             | 3 lbs.                |                                                |                       |
| Martynia, oz. to 100 ft. of drill....          | 5 lbs.                |                                                |                       |
| Melon, Mush, 1 oz. to 100 hills....            | 3 lbs.                |                                                |                       |

The following advice is taken from a prominent seed house: "The thoughtful cultivator will provide himself with a surplus quantity of the seeds he designs to plant, to hold as a reserve for replantings, as dry weather, beating rains and insect depredations often destroy the first sowing."

## WATER SUPPLY.

The next important item to be considered is a bouniful supply of the purest and coldest water obtainable, which should be introduced into the building through large pipes, tapped at several places convenient to the work. The main pipe or pipes should be large enough and pressure great enough to permit the water to be drawn simultaneously at several different points without materially lessening the flow at any one. Water containing iron or sulphur compounds should not be used in syruring or brining, but may be used for all other operations of the plant. This also applies to a brakish water, especially, that containing any percentage of iodine or bromine. As but a small proportion of the total amount of water consumed is used in syrups or brines, if pure water cannot be procured from other wells or different sources, sufficient may be secured for these purposes by distillation. This process must be conducted by a special apparatus properly handled; not by collecting the condensed steam from the boilers in iron pipes, as water so obtained is apt to be contaminated to a certain extent, particularly if boiler "compounds" are used to prevent scale.

## CAPITAL REQUIRED.

Following the selection of a suitable locality, the paramount consideration is the providing of ample capital to properly install the plant and meet all ordinary operating expenses, with command of such credit as will enable the borrowing of sufficient money on favorable terms for the extraordinary expenses of the packing season, and, if necessary, for the storing and carrying over of stocks until they can be disposed of at a reasonable margin of profit above the cost. *For the benefit of all concerned in this great industry, the parties directly interested, the trade in general and the consumers, thus including everyone of a vast population, the evil effects attending the establishment of packing houses with insufficient capital and poor credit, cannot be too strongly condemned.* Sooner or later it almost invariably results in failure of the concern through marketing of goods at less than the cost, or the depositing of them as collateral in warehouses at ruinous rates of interest and charges, to secure funds to meet pressing obligations. In either case this means loss on the business done and in deterioration of the plant. Facing such conditions, it is not human nature to expend any more money on improvements, and to make just as few repairs as possible. It is a self-evident fact that in these days of intense competition, in order to be successful it is absolutely necessary to keep the factory and its equipment in the highest state of efficiency and to meet all financial obligations promptly.

The amount of capital required to properly conduct the business varies quite as much as the difference in various establishments,



but it may be broadly stated that experience has shown that factories of a daily capacity of 15,000 cans or over, working on either corn or tomatoes, should be capitalized at twice as many thousand dollars as the daily capacity of the factory is in thousand cans of finished goods. For example, a tomato canning plant with an output of 20,000 cans daily should have a capital of \$40,000. Estimating that the complete plant cost \$15,000 to equip, thus leaving \$25,000 for working capital, the season will average about five weeks, putting up a total of 25,000 cases, at a cost of say \$1.40 per dozen, or a total cost of \$70,000. Therefore, such a concern should be in shape to command \$20,000 to \$35,000 in addition to their capital stock, either as ready money or credit. A concern working on a larger variety of crops for five or six months in the year, figuring on the same basis of 20,000 cans daily capacity, would require a capital of \$50,000; and, if extended to a winter pack, practically covering the entire year, would require not less than \$100,000 as capital.

### LABOR.

It is important to be sure that all the resident labor necessary to conduct the more important and responsible operations of the factory is at hand, and that sufficient floating labor can be obtained for the rougher work and during the times of extraordinary rush. For a factory packing a comprehensive general line, the supply of cheap, floating labor will determine, to a great extent, the nature and character of the labor-saving machinery necessary to install, but until every operation of the canning factory can be done automatically, careful attention must be given this labor question. To packers old in the business the question of automatic machinery, or machines in the place of "hands" has been answered in favor of the machine. While the bulk of the work done around a cannery is not such as to require "skilled" labor, the help should be such as may be depended upon. Nearly all factories have to import help during the rush season, but for this very reason it is very difficult to secure good help when wanted.

The importance of this consideration cannot be overestimated, because the loss of raw material from inability to handle it, on account of lack of help, in a few days may eat up the profits of the entire pack. Every year we hear of many factories having to allow large lots of green fruits or vegetables to go to waste and be thrown away, after having been received from the growers, on this account. Or, if an attempt is made to "work up" the surplus, it will be necessary to do night work, and while this can always be counted on as a certainty during the busy season, it becomes a source of much trouble to the superintendent if it is too frequent. For the help, after working from 6 o'clock in the morning, do not care to work after 6 in the evening, and while the extra wages earned by

working "overtime" a couple of days in the week will be sufficient to induce them to do so, if more time than this is attempted, they will either slight the work of the next day, or stay away from the factory altogether. Either case makes trouble that it is well to try to provide against.

Here, too, the superintendent should exercise good judgment in handling the help, so as to get the best work out of them without constantly worrying them or seeming to "nag" after them at all times. This, however, will be taken up in its proper place, together with the best means of keeping time etc., the object here being merely to impress upon all packers the necessity of providing as much before hand as possible, for a plentiful supply of good help.

### TRANSPORTATION FACILITIES.

In deciding on the location of a factory, the question of satisfactory facilities for transporting the finished goods and obtaining supplies at such freight rates as will put the factory on an equal basis with competitors in the same line must be fully considered. Even if there may be some advantage in buying the raw materials a trifle cheaper, this will not counterbalance excessive freight rates, or a long haul with animals as motive power. In respect to transportation facilities, the ideal situation is on a body of navigable water with siding from the main line of the railroad to either side of the factory.

### FACTORY SITE.

The site of the plant, if at all possible, should be on high ground, having good natural drainage. Stagnant water, under or around the building, especially if contaminated with refuse and waste which is always a possibility about any canning factory, may form a breeding place for various microbes which will do incalculable injury to the pack.

To prevent water and waste lodging under the factory both the peeling and packing departments, if not the whole building, should be provided with water-tight floors sloped to gutters, emptying into drains which convey it away from the building.

### PROPER FLOOR CONSTRUCTION.

For a working floor in the factory proper, nothing has been found for its cost equal to that of Portland cement construction. If properly finished as to surface, it is practically impervious and may be easily cleaned with a hose. It is sufficiently hard to enable the setting of ordinary machines directly on it, and it resists wear due to walking upon it indefinitely. Careful attention should be given to the grading of the surface of the finished floor where much water



is used. The grade should be not less than one-eighth of an inch to the foot, and one-quarter is better. The length of grade in any direction should not be more than sixteen feet. Where it is necessary that some water should run over the floor where persons are working, an excellent plan is to form in the surface of the floor half-round grooves one inch wide, four inches center to center. These grooves carry off the greater part of the water, thus giving a reasonably dry working surface.

Should it be necessary to use wheeled trucks continually over any part of the floor, no joints whatever must be made in the surface. The slight jar of iron wheels passing over joints will soon pounds out the concrete, resulting in a hollow which must be patched. Naturally, the concrete worker will insist that the floor will crack if no joints are made. In this he is right, but the cracks will be so small that trucking will not generally affect them.

### MACHINERY.

Where machinery can be used in the operation in the place of hand work, it should by all means be done. We are not unmindful of the claims of quality on some articles on this account, but it is a fact the machine is cleaner than hand work, and that is the point. However, speaking generally, the canned food packers must learn how to better treat and use machinery. In no line of manufacture in the country is machinery as much abused or misused, and it is generally due to the fact that the machinery is not understood. The more mechanical a factory is the better it is; and it is because of this condition in some lines of packing that those lines can boast over the less fortunate, and which really make them an exception to the general line of canned products. There are a number of tried machines that should be in every factory, large or small, and which would save the operator expense and money.

### DRESSING ROOMS.

Before going into this matter, let us try to answer all those objections that are arising in your mind. We know there are some facetious ones who will ask if they must not furnish Turkish baths and manicurists, lady hair dressers, maids, etc., but disregarding these, there are others who will plead that the season for canning tomatoes and many of the other articles is too short to warrant expense of dressing rooms, and the profits of the business absolutely preclude them. For unless these ideas be put to rest, there is no use going on with what should be done along this line.

Will it pay you to have proper dressing rooms for both men and women employees, equipped with closet and toilet arrangements? We say yes; further that it will be the best investment

you can make. Some of the best arranged factories in the country, as far as the help are concerned, are food factories, and the fact stands as their best advertisement. If you have a good-sized, well-ventilated room, one for the men and one for the women, but the latter particularly, wherein they can change their clothes, and keep their aprons, etc., equipped with one or more flush closets according to the number of hands employed; proper wash basins with a supply of clean towels, you will find that you are not only doing what you absolutely should do in common decency, but that you will be able to raise the standard of the help in the factory. You will be able to get better help, and they will begin to take care of their appearance, to be neat in their persons and their work; and, what is of the greatest value to the industry at the present time, you will turn that vast army of workers into a host of living witnesses and cheerful testifiers to the wholesomeness and cleanliness of canned foods. You will make these workers brag of the goods, instead of damning them, as they often do.

You have plenty of water, see that you have wash troughs (sinks) for no other purpose than for washing the hands, and supplied with towels. There should be several of these at convenient points about the factory, as well as in the dressing rooms, and the hands should be MADE to use them. It ought not to be necessary to mention this, or to say that cleanliness demands it.

When you have these things, then you can compel the workers to keep the tables and machines free of aprons, rags and such unsightly objects; with the walls nicely painted or whitewashed, and the floors free of muck and slop, you will have a factory that you will be proud of, that the hands will boast of, that you will get more and better work from, and which will turn you out a better profit, fewer rejections, and few or no "kicks."

### CLEANLINESS OF WORKERS.

Then the dress of the women must be looked after, and they must not be allowed to come to work in rags and filth. Keep in mind that they are working on food, that people have to eat what they handle, and think what a sight such a horde of workers would make to the public. See that their hands are free of running sores—for they very frequently have them—and that they wash before they commence work, and after using the toilet. Right here very serious thought can be expended with good results. Do not, under any circumstances, allow consumptives to work on foods. See that the "force" is a clean and healthy one.

At the beginning of 1919 the entire industry was considering the installation of the National Cannery Association inspection plan, as then in force with the sardine packers of Maine and California, and which had been installed in Southern California among the



fruit and vegetable canners with great success. Briefly, this plan consists of inspection under the auspices of the National Association, and upon full compliance with all regulations and standards a certificate of the Association, certifying to such inspection, is issued and placed upon the cases. There is but little question that this plan will spread over the entire industry in the next year or two. The cost is low, estimated at  $\frac{1}{2}$ c per case; the plan has the endorsement of the Federal and State food authorities, and the buyers of canned foods naturally give preference to inspected goods.

The following are the first rules issued by the Committee on Inspection, but the reader will do well to keep in touch with the National Canners' Association, or follow this matter closely in *THE CANNING TRADE*, as additions will surely follow:

### RULES AND REGULATIONS FOR SANITARY INSPECTION

Factories preparing food products shall be located so as to be able to receive and distribute their products promptly, without danger of damage or deterioration, and shall not be located in the immediate vicinity of any other industry which may be objectionable because of noxious odors given off, or because of the use of decomposed products.

No food factory shall be located in an unsanitary place or one which cannot be made sanitary or maintained in a sanitary condition.

No food factory shall be located where the refuse from the plant cannot be disposed of in a sanitary manner, and not of itself become a nuisance to the factory.

No litter, waste, refuse, or decomposed products shall be allowed to accumulate in or around the buildings or yards. All liquid waste shall be conducted from the building by means of suitable drains. Gross by-products suitable for other usage, as pea vines or corn husks, may be stacked or placed in silos separate from the building, and must be properly drained. Other by-products may be retained only if rendered unobjectionable. Raw tomato skins, cores, etc., shall not be permitted to be piled near the factory.

All buildings used for the manufacture of food products shall be clean, properly lighted and ventilated. The ceilings shall be of sufficient height to permit ample clearance for all work under any suspended shafting, hangers, piping, galleries, etc. Where natural light and ventilation are insufficient, provision must be made for augmenting the same by mechanical methods. The interiors of all working rooms shall be kept a light color by paint, whitewash or other suitable method.

The floors of all rooms used for manufacturing should be water-tight and pitched enough to carry all waste to the sewers.

Gratings should be provided around cookers, washers, and at other places where overflow is unavoidable.

All scalders, blanchers and tanks of water in which a product is held, as tomatoes before scalding, and peaches and pears before filling into cans, shall be provided with a continuous fresh supply and an overflow.

No cans shall be brined or syruped by passing through a tank to receive the brine, syrup or water by submergence—"dip tank."

All tables, pails, pans, trays, utensils, conveyors, machines, floors, etc., shall be cleaned with steam and water at the close of each day and as much oftener as is necessary to prevent souring or unsanitary conditions. There shall be ample water and steam supply to keep the factory clean.

Roadways about the factory should be sprinkled, oiled or otherwise treated to prevent dust.

Only potable water shall be used in making syrups or brine, or in washing equipment coming in contact with food.

Cans must be washed immediately before being filled.

All fruits and vegetables shall be washed before canning.

Toilet rooms must be maintained, and where different sexes are employed they must be separate for each sex, plainly and distinctly marked, and to be used only by the sex designated.

Toilet rooms, including the walls, floors, ceilings and all fixtures must be kept clean and provided with sanitary paper.

Toilet rooms must open to outside light and air, and be of sufficient size and equipment for the number of people employed.

Where toilet rooms are in the factory, they must be supplied with proper flushing appliance and connected with a sewer.

Outside closets must be sufficiently removed from the factory to avoid being a nuisance, and built tight above the ground. The doors constructed to remain closed, and the building properly ventilated, lighted and screened. The vault to be kept thoroughly disinfected and cleaned when filled to a level with the ground.

Wash-rooms must be provided, conveniently located and of different size and equipment for the accommodation of all employees and separated for sexes, equipped with running water, and provided with individual or sanitary towels and plenty of soap.

Sanitary drinking fountains shall be conveniently placed for employes, and common drinking cups prohibited.

Where a change of clothes for work is necessary, dressing-rooms must be provided and hangers or lockers provided for street clothes.



No person afflicted with infectious or contagious disease, or infected wounds, shall be employed in a factory preparing or canning food.

Employes are prohibited from using tobacco and from spitting on the floors.

Employes must be properly clothed for the work to be done.

Employes shall keep the finger nails clean and short, and wash their hands before commencing work, and after each absence from the room.

Any dispute between an Inspector and a Canner, relative to these rules and regulations, shall be referred to the Chief Inspector of each State, it being understood, however, that the Canners shall have the right to appeal from any decision of the Chief Inspector to the National Canners' Association.

## INSPECTION OF CANNERIES.

During the war the Army and Navy had their own inspectors in the field, and the following were the regulations issued by them. They will serve as a splendid guide to all canners:

The general information in this bulletin applies to all factories where vegetables and fruits are canned. The sanitary conditions of the premises of such establishments should always be regarded as of the utmost importance, especially where food products for the use of the Army are prepared. An inspector, whose duty it is to pass upon the products of a cannery, should as soon as possible become informed as to the plant and its equipment. He should know the exact condition of all raw materials used, and thoroughly familiarize himself with the methods employed in grading and packing the products. The manner of storing the finished goods should receive careful attention.

## FACTORY PREMISES.

*Location.*—The surroundings of a factory are frequently indicative of the character of conditions on the inside. A factory engaged in preparing food products cannot afford to disregard any detail of cleanliness. The inspector should carefully note, for instance, the proximity of the plant to objectionable factories, stables, pig-sties, manure heaps, privies, etc.

*Entrances to Factory.*—A well-kept plant should maintain its drive-ways in good condition. They should always be free of mud-puddles. To keep dust down as much as possible and prevent dirt from finding its way into food products, all drive-ways should be sprinkled as often as may be necessary.

*Disposal of Refuse.*—A canning factory necessarily has to dispose of large quantities of refuse material, and consequently all ditches and drains should be kept free-running and never allowed to get clogged with juice and trimmings. Waste materials, such as trimmings, vines, shucks, cobs, etc., should not accumulate in the factory or about the premises, but should be promptly removed and cared for, so that they may not become a menace either to the wholesomeness of the food materials or to the health and cleanliness of the employes.

### INTERIOR OF FACTORY.

*Floors.*—All floors in the factory, especially in those rooms where food products are prepared and canned, should be constructed so as to be water-tight. This is an important precaution, if refuse matter is to be kept from finding its way under the building, where it is sure to undergo fermentation and decay and become a nuisance. An additional reason for tight floors is the necessity of daily flushing them with water. For this purpose, the factory should be well provided with hose, brooms and brushes.

*Walls and Ceilings.*—To remove all chance for concealment of uncleanness, the walls and ceilings of the factory should be painted white or white-washed often enough to keep the rooms bright and clean. Compliance with this sanitary measure will add to the lightness of the interior and make it difficult for cobwebs and dust to accumulate without being seen.

*Equipment.*—All machines, conveyors, tables, pails, and other utensils should be frequently examined, to make sure that they are thoroughly clean. To maintain all articles of equipment in a clean and sweet condition, steam or hot water hose should be provided. In tomato canneries it frequently happens that pails made of wood or of wood-pulp, and wooden tables become coated with a slimy substance. Once it has formed, the removal of this deposit by simply washing with a cloth and water is impossible. Only by using a stiff brush can this material be wholly removed. Consequently the factory should provide sufficient brushes to prevent the occurrence of this insanitary condition.

If the baskets and boxes used for carrying shucked corn are not frequently washed with a brush, they soon become coated with dried kernels and milk from the bruised grains. The huskers, conveyors, cutting machines, silkers, and filling machines should also be thoroughly cleaned as often as may be necessary. Brine-tanks in pea and corn canneries should be examined to make sure that they are provided with suitable coverings to prevent introduction of foreign substances into food products during their preparation. They should also be in a carefully screened room. This is especially important because the solution contained in these tanks is of such a nature that it attracts flies, bees and other insects.



In tomato canneries the kettles or tanks in which juice is heated and the sirup machines used for filling the juice into the cans should be examined for water pipes which may be used to introduce water into the product. Considerable water will also be added through the condensation of steam from the open steam pipes in the kettles and tanks.

*Cleanliness of Cans.*—The condition of the interior of empty cans should be noted, to make sure that they are free from all foreign substances when they reach the filling machine or packing tables. Some canners have adopted a combination steam and water-spraying device, so that cans are thoroughly washed and rinsed in passing through the can-chute from the loft to the packer.

*Ventilation.*—To add to the comfort of employees, and at the same time to improve the sanitary conditions of the factory, ample ventilation should be provided. The number of windows, doors, and roof ventilators should be adequate. Moreover, suitable ventilators for escape of steam from the process-kettles, scalders, etc., should be provided.

*Lighting.*—To insure proper preparation of all materials used in canning, it is essential that efficient lighting facilities be provided. Natural light is always to be preferred to that from an artificial source. Good lighting facilities for the tables where fruits and vegetables are prepared, should be available, as well as for the machines or tables where these products are put into cans.

*Employees.*—The class and nationality of the employees in the factory should be noted. If enemy aliens are employed, that fact should be stated and the number of each sex given.

*Cleanliness of Employees.*—Inspectors at factories engaged in packing fruits and vegetables should see that the number of basins, soap and clean towels is sufficient, and that an abundant supply of running water is maintained. All employees, whose duty it is to handle or prepare food products should be required to wash their hands before they begin working in the morning, when they finish their lunch, and upon their return from the toilet.

*Health of Employees.*—No person having a communicable disease, or unprotected sores upon the hands, should be permitted to assist in the preparation of food products for canning purposes.

*Dressing Rooms.*—Inspectors should note the condition of the clothing of all employees about the factory and insist upon thorough cleanliness. This requirement is especially important in the case of those persons whose duty it is to handle fruits or vegetables during their preparation and packing. In tomato canneries aprons made of oilcloth are preferred. Women should be compelled to wear caps which entirely cover the hair. Articles of clothing should not be hung on the walls of work-rooms.

*Toilets.*—Unless the toilets are of modern construction and properly flushed, they should be at least 100 feet away from the cannery. The ground selected for their location should slope from the factory, to remove all chance of contaminating the water supply with sewage. If the factory has only ordinary outside toilets, the vaults should be thoroughly screened against flies, the floors kept scrupulously clean, and disinfectants liberally used.

*Water Supply.*—No detail of factory equipment is of more importance than the water supply, which should be bountiful and pure. In no case should water be taken from questionable sources, such as canals, rivers, or streams which may be polluted with sewage, surface drainage, or refuse material from other factories. Shallow wells should be carefully avoided. If the water supply is under suspicion, it is advisable to have samples taken under proper conditions and submitted for chemical and bacteriological examination at laboratories qualified to do such work.

*By-Products.*—In tomato canneries, if pulp is made from skins and cores, the process of manufacture should be carefully noted, as well as the condition of the raw materials and the manner in which they are handled.

## A MODEL HAND-PACKING PLANT.

The floor plan of the factory herewith presented has a daily capacity of 5000 cans and upwards, and is intended exclusively for hand packing. The main building is two stories, 50 ft. x 40 ft., with a one-story building at end 30 ft. x 40 ft., to be used as the peeling-room, and which may be inclosed, if used in winter, or left open if used only in summer packing; also a structure on one side, 20 ft. x 20 ft., to contain the boiler, process kettles, exhaust tank and cooling tank, and dressing rooms adjoining.

The second story of the main building is used for can and general storage, with shoots leading directly to the packing tables and tomato filler, if a filler is used. The entire 20 feet of the opening to the boiler house should be left clear, excepting for a middle post, which may also be utilized for the upright of the crane.

Owing to the absence of shafting and machinery, the scheme for arranging the furniture and fixtures is quite simple, but the following details are suggested:

Presuming that the end of peeling shed faces east, with boiler room on south, place the peeling tables (see description) lengthwise in southeast corner of shed 3 feet apart; the packing table (see description) crosswise 3 feet from peeling tables, and the machine or seamer in the same manner 3 feet from packing table. Place the exhaust box so that the cans will pass to it directly from the seamer;



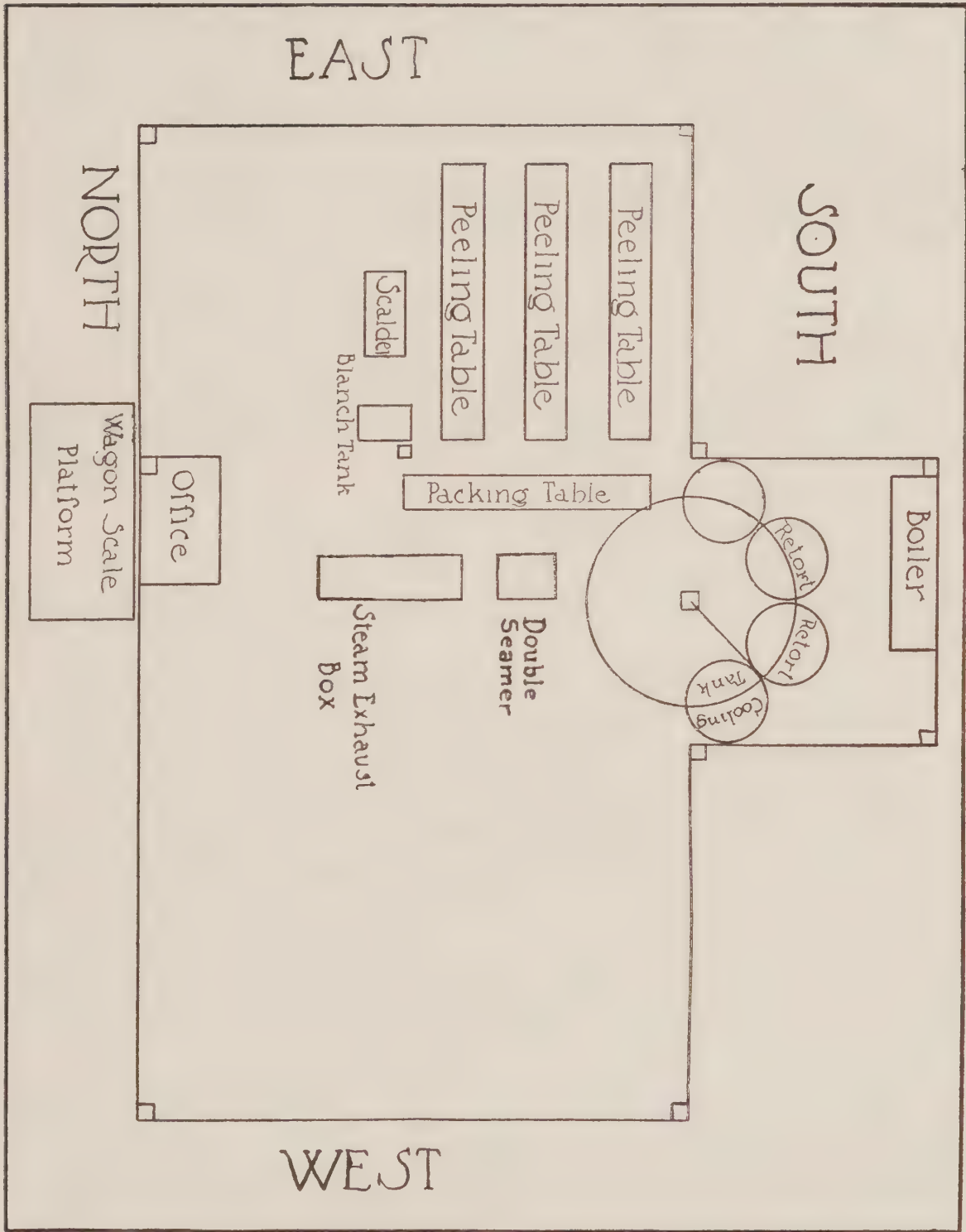

Design of Model Hand-Packing Plant.

the scalders opposite the peeling tables, and the blanching tank near the packing table

Elevate the brine tank 8 feet above the floor, and place in such a position that it may be filled through an opening from the second floor. Lead pipes from this directly to the packing table. Locate the process kettles, and cooling tank in the extreme east of the room.

For packing a comprehensive line, including baked beans, an outfit similar to the following will be required:

One 4-ton Wagon Scale.

One 30-Horsepower Boiler, complete, with all trimmings.

One 20-Horsepower Engine.

14-Inch Steam Pump, 2 30-barrel Water Tanks.

One 160-gallon Jacketed Copper Kettle, two Closed-Top Process Kettles, 40 in. x 72 in.

One Square Steam Exhaust Box.

One Iron Open Kettle, 40 in. x 24 in.

One Hand Crane, or one Hand Hoist on track.

One Cooling Tank, one Brine Tank (wood), one Blanching Tank.

One Sanitary Closing Machine (seamer).

Twelve Process Crates (3-tier).

One Steam Scalders (see Proper Tomato Scalders).

One Set Small Platform Scales, 12 10-lb. Counter Scales.

Three Peeling Tables (see Peeling Tables).

One Packing Table, 3 ft. x 18 ft., 2-inch depression; 2-inch end pitch; zinc-lined.

Two Floor Trucks, fitting Steam Exhaust Box; two Crate Trucks, 2000 Peeling Checks, eight dozen Peeling Knives, eight dozen 14-qt. Buckets, one dozen Scrub Brushes, one Combination Vise, two Fire Extinguishers, or Six Fire Buckets.

Also a moderate stock of sundries, including Apple Paring Machines, Cherry Seeders, Blanching Baskets, Peach Pitting Spoons, Oak Barrels for soaking and washing, Tin or Copper Measures, Tin or Copper Cup Measures, Nest of Sieves, assorted meshes; Valve Packing, Valve Disks, Can Openers, Can Testing Thermometers, Can Funnels, Chemical or Bath Thermometers, Hydrometer for Syrup, Rubber Hose, Salt, Sugar, Catsup, Flour, Red and Black Pepper, Vinegar, Molasses, Sal. Soda, Lime.

Extra valves, pipe and pipe fittings, shovels and scoops. An assortment of small tools, hatchets, wrenches, machine hammer, pipe tools, etc.



Cans and cases, lacquer, labels, box and shipping stencils, stencil ink and brush, paste and brushes, nails, brooms, stable brushes.

There will be required to operate this plant: One Sub-Processor, one Kettle Man, one Fireman and Steam Fitter, one Seamer Man, one Warehouseman and one Shipper, and 40 to 80 hands.

This plant may be greatly improved so that a much larger variety may be packed by adding a hand crane with a power crane and a pea huller and grader; a small corn line, comprising cutter, cooker and filler. A steam oyster box, with a suitable outfit of tracking and cars, may be installed on outside of building under a shed for use in preparing crabs, clams and oysters.

Thus equipped, this factory is capable of preparing and processing about every variety of food products that is likely to be found in any one locality; and, if properly conducted, of handling them in such an economical way that for their own local and immediate markets all competition from outside concerns may be met

### PEELING TABLES.

For peeling tomatoes, in particular, the tables should be built to slope to the center to an opening entering into a drain. The scalded tomatoes should be brought to the peelers in pans, rather than buckets, and be peeled from these pans, the skins being dropped back into the pans and the peeled tomatoes into special buckets, used for this purpose only. This will avoid the slop and wet incident to peeling tables where the tomatoes are thrown into bins or troughs, and the skins into other gutters in the tables, and pushed out at the end by paddles. These pans may be emptied into conveyors, at the end of the line of tables, which will deposit the skins and refuse in the slop cart, to be removed at once.

### THE PROPER TOMATO SCALDER.

If you use the hand dump scalding, install at least two, if not three of them, so that a quick change from one to the other may be made and the water in which the tomatoes are scalded *kept clean*. If you do not want your goods seized by the pure food authorities and destroyed as unfit for human consumption, see that the water in your scalding, whether hand-dump or power, is kept clean. This can only be done by frequent changing. In using two or three such scalders one may be used as a washer, the tomatoes being first rinsed off in it and then scalded in the next one. Keep the surroundings of these scalders as clean as possible.

## A MODEL CANNING FACTORY (Power)

The floor plan presented in the back of this book gives a scheme for the installation of the permanently fixed machines and apparatus for a plant having a capacity of 20,000 to 25,000 cans daily, suitable for an all-the-year-around pack, covering an extensive line of products and so equipped as to employ as much labor-saving machinery as can be worked advantageously with a minimum of manual labor, and producing satisfactory results both in regard to economy of operation and appearance of finished goods.

### THE PEELING-ROOM.

*(See design at back of book)*

In the peeling-room is to be placed the special machines and apparatus employed, which are set, moved or taken down, as the requirements of the different seasons demand. For convenience in referring to it, this room has been divided, as shown by the lines in the plan, into blocks four feet square, numbered from 1 to 312, and the proper position of such machines and furniture required in the handling of the various products will be designated by the number of the block or blocks in the text treating on the article to be packed. The peeling-room, 48 feet x 104 feet, beside the movable apparatus, also contains three jacketed copper kettles and the receiving clerk's office, outside of which a four-ton wagon scale is located for weighing the loaded wagons, having the scale with the beam in block No. 277.

### PROCESS ROOMS.

The Automatic Continuous Cooker is designed to reduce the amount of handling of the cans, and by doing away with the process kettles to make the operation continuous. The cans roll from the sanitary sealing machines into the cookers, and the processing or cooking begins at once. Moreover, a considerable decrease in the length of cook is effected through the agitation of the contents of the cans while cooking. The saving in labor and the amount of steam used make them valuable considerations. They have proved very effective upon fruits and such vegetables as require comparatively low temperatures, but are untried, as yet, on processes requiring from 240 degrees up.

In the process-room are seven retorts 40 inches x 72 inches (set in floor with working platform in front), in single line with power traveling hoist over head for handling crates; also a cooling tank equipped with either a continuous conveyor in bottom or overhead.

If an overhead tramway is adopted for the tank, it may be arranged to continue to the warehouse, and by use of suitable tracks and switches the crates may be delivered to any desired point. The boiler house, located at the side of railroad convenient to the coal



supply, should have two 50-horsepower boilers (see Boiler Capacity). Either the main siding or a spur at this point should be elevated on trestlework for convenience in unloading hopper cars. If the main siding is elevated in this way, continue it so to the end of peeling-room, where tomatoes may be unloaded in a shoot discharging directly into the washer and scalders.

### THE ENGINE-ROOM.

This is also to be used for the storage of machines not in service and as a machine shop for general repairwork, and to be supplied with a full complement of pipe tools, machine tools, etc., by all means including a portable forge and anvil, a power drill press and a small lathe. The drill and lathe will prove a great convenience and pay for their cost many times over in a season.

The scheme for the shafting and piping of this plant after the machines are in place will readily suggest itself to any practical man familiar with the business, and as such a man *must* be at the head of a factory of this magnitude, it is not necessary to go into the details of this arrangement.

### BOILER CAPACITY.

A plentiful supply of dry steam is a very necessary requirement, and a good boiler of ample size should be purchased. Aside from the initial cost, it is much cheaper to install a boiler of nearly, or quite, double the capacity that you anticipate using. A small boiler, taxed beyond its capacity, will consume more fuel in proportion, much of the time will deliver wet steam, and be more likely to break down at critical moments. In large plants where steam is used in several departments, especially if the departments are situated on different floors, it is economical to use high pressure boilers up to 180 to 200 lbs., with properly adjusted reducing valves placed between the boiler and department mains. A factory designed to operate for a long season, or through the entire year, instead of one large boiler should provide a battery of two, each of sufficient size to run the factory at its full capacity. The extra cost of two is more than offset by the fact that the disabling of one will not cause a shut down of the plant. This is particularly true when the factory is at some considerable distance from its base of supplies, for as the ratio of time distance from the base of supplies, so is the comparative cost of a breakdown during the packing season. Regarded in one sense, the installation of two is a practical method of insuring against possible loss of time and raw material, the premium on the policy costing only the interest on the extra money required for two boilers instead of one. It is, of course, understood that when both boilers are in order they are to be run as a battery, not singly, thereby obtaining virtually the same advantages as from one large boiler.

# SUPPLIES

## CANS.

As containers for all varieties of fruits and vegetables, cans, constructed of tinned iron or steel plates, are universally used, but with a great many, glass jars or bottles are preferred for fancy or extra fancy goods.

Cans are of two types, the solder-top and the open top, or so-called sanitary type. The solder-top is the older, but is being rapidly superceded by the open top for all lines of work, except meat packing. The solder-top can is the safer for use with products requiring a high temperature for a long time. The open-top or sanitary can has the very great advantage of being easily cleaned, easily filled and sealed by automotice machinery. It has the advantage of being ready to operate at any time, and there is no waiting to heat irons or any overheating of the factory. The automatic machine does require one skilled attendant to see that the closure is perfect. More care also is required in processing peas, corn or other high-temperature products, or the ends may be sprung or leakers develop.

The sanitary or open-top cans have so nearly supplanted the old-style-hole-and-cap cans that all considerations here are written with the sanitary style of can in view.

Practical automatic can-washing machines are now on the market, and unquestionably the time is now here when all cans must be thoroughly washed before filling or using.

### SANITARY CANS.

|                   | Diameter.   | Height.    |
|-------------------|-------------|------------|
| No. 1 size.....   | 2 11-16 in. | 4 in.      |
| No. 2.....        | 3 7-16 in.  | 4 9-16 in. |
| No. 2½.....       | 4 1-16 in.  | 4¾ in.     |
| No. 3, 4⅞ in..... | 4¼ in.      | 4⅞ in.     |
| No. 10.....       | 6 3-16 in.  | 7 in.      |

*(Always refer to cans by number, never by pounds.)*

When shipped in bulk the average car will contain about 85,000 No. 2 cans, or 55,000 No. 3 cans. When shipped in cases will average about 54,000 No. 2 cans or 2,250 cases, and 36,000 No. 3 cans or 1,500 cases.

Can making is a business of itself, requiring highly-specialized machinery and thoroughly trained mechanics, so that a factory which does not do a large volume of business or run continuously cannot afford to take up this line of manufacture.



## THE STOREHOUSE FOR EMPTY CANS.

The storage house must be protected from dampness and steam and should be at such an elevation above the packing tables or filling machines that properly constructed chutes will deliver the cans by gravity, to points where they are filled. When storing cans in bulk in bins, lay on side in even and regular tiers. When stored in shipping cases, place the bottom layer end up.

## THERMOMETERS.

Both thermometers and gauges should be frequently compared with standard instruments known to be correct. Thermometers particularly should be tested every year.

According to "Kent," under ordinary conditions at the sea level the air pressure is 14.7 pounds per square inch, and steam is formed at a temperature of 212 degrees Fahrenheit; gauge pressure will give temperatures as follows:

| Gauge pressure:<br>pounds per sq. inch. | Degrees<br>Temperature F. |
|-----------------------------------------|---------------------------|
| 0.304                                   | 213.0                     |
| 1.3                                     | 216.3                     |
| 2.3                                     | 219.4                     |
| 3.3                                     | 222.4                     |
| 4.3                                     | 225.2                     |
| 5.3                                     | 227.9                     |
| 6.3                                     | 230.5                     |
| 7.3                                     | 233.0                     |
| 8.3                                     | 235.4                     |
| 9.3                                     | 237.8                     |
| 10.3                                    | 240.0                     |
| 11.3                                    | 242.2                     |
| 12.3                                    | 244.3                     |
| 13.3                                    | 246.3                     |
| 14.3                                    | 248.3                     |
| 15.3                                    | 250.2                     |

If your thermometers and gauges do not agree with this table, have them tested.

## LABELS.

Labels are generally abused in a canning house. Provide a dust and steam-proof room of such dimensions and so arranged that each size and variety of label may be separate by itself in a bin or pigeon hole. Have the shelves of generous width, so that labels when stored crosswise will be entirely supported and not hang over the edge. When labels are received wrap each bundle in paper, pile on shelf neatly and squarely, printed side up. Insist that loose

labels when returned to the shelves be neatly placed and not thrown in promiscuously. Give one person entire charge of the labels and the room and hold him or her responsible for condition of the stock.

In purchasing labels, remember that "well dressed is half sold," and that a neat, attractive and distinctive outside label costs but a trifle more per dozen for the finished goods than the gay and gaudy stock affairs that at once stamp the goods as being cheap.

The label should carry the following information: First, the name of the product; second, the name of the manufacturer; third, the place of business or the chief office of the manufacturer; fourth, a declaration of the net weight, or in the case of liquids, the volume of the product. In event the product is a mixture, the label must declare the fact and give the component parts in the order of their predominance. If any permissible matter, such as starch or color be used, that fact must be disclosed. The label may also have the name of the brand and illustrated design, but the latter must not be misleading in any particular.

And we would like to suggest the use of one or more good recipes for use of the goods in cans particularly. It is far better to tell the consumers how rightly to use the contents on the table than to use this valuable space for pictures or designs. Use this unexcelled advertising opportunity to promote increased consumption rather than as an art display.

"Honesty is the best policy" is an old adage that apparently many packers have forgotten. Whilst honesty may seemingly not pay at first, in the long run it will pay to be honest in labeling goods correctly. A consumer may buy first through the eye, then through the smell, then through the taste in certain lines of food products, but in canned foods one must buy through the eye or by reputation of the brand. Neither the fine label nor the previous reputation of the brand will hold the consumer as a customer if seconds are branded firsts. It is advisable to have distinctive labels, registered or copyrighted, both to protect yourself from imitations and to avoid the appearance of having imitated the design of some other concern of whom you have probably never heard.

Label cans with cap end down, and, if labeling by hand, allow, if possible, sufficient time for the paste to dry before casing. Protect expensive labels, such as gilt and embossed, with an outside wrapper of tissue paper. The modern factory uses a labeling or wrapping machine for this work.

#### REQUIRED WEIGHT ON LABELS.

(See laws in back of book or the yearly *Almanac of the Canning Industry*.)



## MINOR SUPPLIES—SUGAR.

*Sugar in Canning Vegetables.*

BY DR. W. D. BIGELOW,

*National Cannery Association Laboratories, Washington.*

Inquiries are frequently received from canners regarding the suitability of cheaper grades of sugar than standard granulated for canning of vegetables.

In addition to standard granulated, we have on the market various grades of soft sugar manufactured as a by-product in sugar refining and sugars of varying degrees of purity which are placed on the market directly by the original manufacturers.

The soft sugars probably present no advantage, as the price for which they are sold is practically the same as the price of refined sugar when we consider the percentage of impurities present.

The sugars placed directly on the market by original manufacturers may often be purchased at a substantially lower price, proportionally, than refined sugar, and their use may be advantageous. Among such sugars may be mentioned beet sugar, plantation-granulated, plantation-clarified, and raw sugar.

## BEET AND PLANTATION-GRANULATED SUGAR.

These forms of sugar are now made in quite a high state of purity. The best grade of beet and plantation-granulated sugar is, for most canners' purposes, at least practically as good as refined sugar. Unfortunately, the manufacture of these products is not always controlled as carefully as the refining of sugar, and there are still some plants that occasionally place on the market runs of sugar which are not of as high a grade as the standard product. Fortunately, even this product is not particularly inferior, and such inferiority as it has is always disclosed by the color. If the product is white, its high grade is assured. Even the off-grades, which, in fact, are rarely met with and which, by reliable sugar mills are sold on sample, will answer for the preparation of canned vegetables, such as corn and peas.

## PLANTATION-CLARIFIED SUGAR.

This product is divided by the trade into a number of grades. The highest grade approaches in purity and quality the granulated sugars referred to above. The lowest grade is of a buff color, has a molasses odor, and a considerable amount of insoluble material.

High-grade plantation-clarified sugar will prove satisfactory for many canners' purposes. Those of lower grade will not answer for corn because their color will darken it. Moreover, a product with a considerable amount of insoluble matter should not be used without filtering. If a canner contemplates the use of this product, therefore, he should obtain a sample and dissolve it in water. If insoluble matter is present in material amount, the product should not be used.

## RAW SUGAR.

Raw sugar is a product manufactured by the ordinary sugar mill. It is of varying composition, and its value is based on the amount of cane sugar it contains. The highest grade of raw sugar contains from 96 to 98 per cent. of cane sugar, and the lowest grade contains less than 80 per cent. The highest grades are of a yellowish-brown color and contain only enough

molasses to make the product slightly moist. The lowest grades are of a very dark, dirty brown color, because of the presence of a considerable amount of molasses. The lower grades of raw sugar are, of course, not appropriate for the preparation of any canned foods except those with which molasses might be used. All grades of raw sugar are likely to have impurities, such as strings and other insoluble matter, and should not be used without filtering their solutions.

For the canning of some products, high grade raw sugar will be found economical and equally satisfactory with granulated sugar. High grade raw sugar is the same in composition as granulated sugar, except that each particle of sugar is surrounded by a film of molasses. This product was formerly sold extensively as brown sugar.

#### SUGAR IN CANNED PEAS.

During the seasons of 1916 and 1917 two experimental packs of peas were put up with a number of varieties of sugar, including representatives of all the groups mentioned above. With a low-grade raw sugar containing from 80 to 85 per cent. of cane sugar, the liquid in the canned peas was very dark. With the high grade raw sugar, containing about 96 per cent. of cane sugar, the liquid in the can was scarcely distinguishable from the liquor of peas packed with refined sugar.

Except possibly with the low grade raw sugar mentioned above, the flavors of the peas packed with the various sugars were equally good, and were scarcely, if at all, distinguishable from each other.

It would appear, therefore, that with canned peas there is no objection to using high grade raw sugars or plantation-clarified sugar, provided the syrup prepared from them is filtered when necessary.

The standard beet and plantation refined sugars, of course, answer equally well with this product as the standard refined sugar.

#### SUGAR IN CANNED CORN.

Experimental packs of canned corn similar to those just described of peas were put up during the 1917 season. The results obtained with corn were the same as those obtained with peas as far as flavor was concerned. In respect to color, the result was quite different.

It was found that any sugar which dissolved in water to form a colored syrup would cause marked increased color in the corn. This increase in the color of the corn was not so apparent when the mixture was first made as it was after processing. Some of the constituents of molasses are caramelized by the heat of processing to a much greater extent than cane sugar. Since the raw sugars and some grades of plantation-clarified sugars, still contain more or less molasses, therefore, the corn packed with them after processing was materially darkened. Fortunately, this is a matter which the canner can determine by dissolving a portion of the sugar in water and noting the color of the solution and the insoluble matter present.

## WASTE WATER IN CANNING PLANTS

BY DR. W. D. BIGELOW,

*National Cannery Association Laboratory, Washington.*

The drainage facilities should always be considered in locating a canning plant. If possible, such plants should be located on the banks of streams of sufficient size to carry away waste waters without creating a



nuisance in the vicinity. Where such a stream is not available, it is often necessary to incur considerable expense in purifying the waste waters, so that they may be allowed to run into the small drains available.

These questions are being studied by the U. S. Public Health Service, which, it is hoped, will be able to make preliminary suggestions before long. In the meantime some difficulties that have occurred recently have been more or less relieved by the suggestions given below.

#### SEPARATION OF POLLUTED FROM UNPOLLUTED WATER.

Where the drainage facilities of a canning plant are not adequate and where it may be necessary to practice some form of purification of the waste waters, much saving can be effected by so piping the drains of the plant that the water which is not polluted may be discharged into the drains without passing through the purification plants.

These waters include the overflow from the cooling tanks, the overflow from the agitating cookers and from retorts where processing is done under water. It may also include the water used for scrubbing and washing the floor if the plant is arranged with screens to keep out of the drain any food that may be dropped on the floor. It is obvious that whether the later draining from the floor can be disposed of without purification will depend on the character of the plant.

#### SCREENING OF WASTE WATERS.

A portion of the waste water from many canning plants carries with it considerable quantities of solid particles of food which may decompose and become offensive if not separated from the waste water. A case was recently brought to our attention in which the waste waters of a bean-canning plant became a nuisance in the community. Investigation of the plant disclosed the fact that a considerable number of the beans were allowed to drop on the floor, and in washing the floor these beans passed into the waste water which was allowed to flow into a very small stream. Along the course of this stream the beans collected in pockets, often to a depth of a foot or more.

The location of this plant was such that if screens had been used for the separation of the beans, the odor caused by the decomposition of the soluble matter would probably not have been objectionable. The decomposition of the beans along the banks of the stream, however, became a nuisance, not only in the immediate vicinity of the plant, but to travelers along the road.

At the beginning of its operation the plant had installed screens. They were made of small mesh wire, however, and became clogged up, damming the stream, so that workmen destroyed them as a matter of convenience.

Better results are sometimes obtained by installing first a relatively large mesh screen for the separation of material that would be likely to clog the smaller screen, and following this with a small mesh screen. The size of the screen should, of course, depend on the character of the waste. In any case, a reliable workman should be charged with looking after the screens and removing the solid matter that is separated by them.

#### DRAINS FROM SILOS.

The question of whether or not drains from silos are objectionable will probably long be a matter of a controversy. In some localities the silos seem to cause no trouble, even where surrounded by residences. In other places, neighbors object to the odors arising from them. Some packers have found it worth while to surround the silos with a cemented area and have drains run

from the base of the silo into a cement sump. Sometimes the drains have raised sides and are covered to keep out rain water. The discharge from the sump may be carried away by pipe or hauled away in barrels or tank wagons.

Analysis of this material made by the laboratory indicate that the fertilizing value of the product will repay for hauling it a reasonable distance.

### SALT.

Salt is a chemical on which many canners try to save money, and usually lose more than they save, by purchasing a cheap grade, which generally contains a greater or less percentage of sulphates, giving the salt a distinctly bitter and disagreeable taste. Pure salt tastes sweet when first placed on the tongue and leaves no unpleasant, bitter after taste. The salt of which the first taste is bitter is not fit for canners' uses.

### CLEANLINESS.

*Last but not least in these preliminary remarks is the subject of cleanliness. "Cleanliness is next to godliness," but, as applied to a canning house, it will have to come before profitableness.*

After each day's run, every machine, every crack, corner and crevice of the packing-room and shed where slop and water can flow and collect must be thoroughly cleansed and flushed with an abundance of water. If the floor is of such a character that slop and water will drain through to the ground, a lavish use of disinfectant is required once a week in cool weather and every day in hot weather.

For this purpose a plentiful sprinkling of dry-slacked lime may be used, though carbolated lime (made by thoroughly mixing one pint crude carbolic acid with a half bushel dry-slacked lime) is preferable.

### FILLING.

Depending on the nature of the article, the requirements of the trade, or the supply of labor, cans may be filled by machines or by hand. Hand filling is more costly, but will naturally turn out some goods more carefully selected, evenly graded and of more sightly appearance than will be the case with machine work. When filled by machine, cans should be frequently weighed and examined during the operation to be certain that they are averaging the amount of materials required. In hand filling each can should be weighed.

### EXHAUSTING.

Cans filled with cold liquid should be exhausted—i. e., heated to a temperature of 120 degrees to 180 degrees, depending on the nature of the substance, before being sealed. This process of exhausting, which expands the liquid contents of the can and drives



out a portion of the air, has no effect on the keeping of the goods, but the cans are not so severely tried in the final process. Defective cans, which have been exhausted, or, what is equivalent, filled with hot liquid, are much more readily detected after processing than "cold packed." Moreover, cold-packed goods, in time, are quite likely to develop "springers" and are apt to be rejected by both dealer and consumer. When goods are cold packed, more carefully made and stronger cans should be used than are usually employed when cans are exhausted or hot filled.

*The exhausting* of cans may be accomplished by piling the trays containing the cans on a truck and placing in steam box, where they are subjected to the action of steam at a very low pressure for a specified time. In this connection it must be noted that from the time cans are filled with hot liquid or exhausted by any method they must be kept in speedy and *constant* motion until in the process kettle. A tight box with open ends into which live steam is injected, equipped with an endless chain carrier, or, even better, one of the automatic exhaust boxes built especially for this purpose is preferable to the first method, as it aids in making a continuous instead of an interrupted operation.

Experience has proven that exhausting sanitary cans is always necessary—an important point in this respect.

### SEAMING OR CLOSING.

All can-making companies conduct schools of instruction for "seamer men," the object being to thoroughly familiarize them with the proper operation of this important machine, and make them experts. These instructions are given free of charge—in fact, the companies are anxious to have the men attend and to see that they are perfected in the handling and operation of the seamers or closing machines.

Canners should take advantage of the opportunity, in the winter or off-months, to train their men in these schools.

A competent seamer man is absolutely necessary in every cannery using sanitary cans, and the knowledge that the man is reliable and knows his machine will prove a source of genuine relief to the superintendent and owner.

### CRATING.

After sealing, pack the cans in process crate, and at the same time count and record the variety, grade and quantity. Attach to the crate a metal tag so stamped or marked that the article and grade may be readily determined by the processor and warehouse men to whom it is delivered.

### STAMPING OR IDENTIFYING.

Every can should be stamped or an identifying mark placed on it as soon as sealed, in order to avoid mixture in the warehouse. There are a number of little machines now on the market by which each can may be indelibly marked with any legend desired. Thus it is possible to place on each can the name of the goods, the quality and the date, if desired, the code being secret. This also guards you against imposition through the rejection of other goods as yours; and in any action by the pure food authorities enables you to identify your goods. It is cheap insurance, but important.

### PROCESSING.

#### *Upon Processing Depends the Entire Pack.*

Processing is the term applied to the sterilizing or cooking of the foods contained in hermetically sealed packages. This may be performed in any vessel of suitable dimensions that can be provided with a constant and easily regulated supply of either boiling water or steam under pressure, during the period necessary to cook or sterilize as the nature of the article or the wants of the market may demand. Wooden or iron tanks, square, rectangular or round, with perforated coils or crosses in the bottom for the introduction of jets of live steam to boil the water, are used for such substances as do not require a temperature exceeding 212 degrees Fahrenheit. This is known as the open-bath process, and the tanks as "kettles."

For substances requiring a temperature of more than 212 degrees, and when it is desired to hasten the operation with those requiring less, iron tanks of various shapes, round, half round, square or rectangular, placed either perpendicularly or horizontally, fitted with doors which can be clamped down, steam tight, are employed. This is known as the closed process, and the round tanks, placed either upright or horizontally, are known as "retorts," the square tanks, of whatever dimensions, are usually designated as "steam chests." Steam chests and horizontal retorts are used with dry steam as a cooking medium; upright retorts may be used with dry steam or with water and steam, as preferred. When the capital will allow the extra initial expense, it is advisable to install retort instead of open kettles. When desired the retorts may be used with lids open, serving the same purpose as an open kettle, and may be equipped with a pump and condenser for the vacuum process which is employed in sterilizing some of the more delicate fruits.

With few exceptions on fruits and vegetables using double the time given at 240 degrees at 212 degrees will give safe results. The important exception is corn, where, unless a special method of preliminary cooking is applied, is quite apt to spoil. Of course, it is understood that fish and flesh meats absolutely require the process at 240 degrees or more.



Occasionally cans of peas and corn will burst when retort is opened—this may be due to imperfect cans or too great a fill. Sufficient room must be left for expansion, remembering that both old corn and old peas will swell much more during the process than the young and tender kinds.

### STERILIZATION POINT.

The sterilization point varies greatly with the different articles. For acid fruits it is low, about 170° F. for ten (10) minutes; for tomatoes about 190° F. for ten (10) minutes; for most vegetables 210° F. for one to three hours; but for others no single process within a reasonable time will destroy the spores, and, therefore, the work must be done in a retort at high temperature. All foods are processed at higher temperature or for a longer time than the minimum as a matter of safety.

That is, when the ENTIRE contents of the sealed packages are heated to this degree the sterilization is complete and the goods will be preserved indefinitely. This point will be reached much more quickly when processed under pressure, with a consequent saving of time over the open-bath process. Kettles should be fitted with a "pocket" for holding a thermometer, and this pocket should be fitted with a pet cock at the top or bottom so as to insure a perfect circulation around the thermometer end. Otherwise this pocket may be "dead," and so show a false register on the thermometer. The pet cock in this pocket should be kept at a slight crack, so that a thin emission of steam will always be apparent.

Besides the steam inlet, retorts should be provided with a top steam exhaust, bottom waste and safety valves; also bath thermometers and steam gauge. Upright kettles and retorts may be obtained, either from stock or by special order, of almost any height or diameter; the size usually employed holds three 4-tier crates of No. 3 cans and measures 40 inches in diameter and 72 inches in height.

### OPEN BATH.

When processing in water in an open bath fill the kettle about half full of water or sufficient to cover the cans and bring to a boil, shut off steam, lower the filled crates in kettle by any mechanical means, throwing the bails of lower crates on side; turn on full head of steam and when the water boils, the thermometer marking 212 degrees, take the time; cut steam down, leaving valve open just enough to keep up a lively boil; when time directed has expired shut off steam and remove crates from kettle.

### AGITATING (CONTINUOUS) COOKERS.

The time of processing many products is dependent upon the rate with which the heat can penetrate to the center of the can, and this takes place much more slowly than is generally known. The heat penetration can be greatly expedited in products of a semi-liquid character or of a mixture of solids and liquids by gently agitating the cans. This is done by rolling the cans at a sufficient speed to agitate the contents not less than seven (7) times per minute, nor with sufficient frequency to cause breaking of the material, and not more than fifteen (15) times per minute. These continuous cookers, while somewhat expensive in first cost, cut down the process about two-thirds in time, make the operation continuous and are economical in operation.

### CALCIUM PROCESS.

If it is desired to obtain a higher temperature than 212 degrees in open bath, or where the altitude is such that water boils at less than 212 degrees, the result may be obtained by using a solution of chloride of calcium instead of water and heating with a closed coil instead of the usual perforated coil or cross. Turn on steam and bring the solution to 212 degrees or the desired temperature; shut off steam; lower in crates, first washing the cans to keep bath clean as long as possible; turn on full head of steam until the desired temperature is attained, take time, then cut steam just sufficiently to keep bath at proper temperature. When process time has elapsed turn off the steam and remove crates from kettle. Wash off the chloride of calcium by turning on water from a hose or by passing through a cooling tank supplied with a constantly changing stream of cold water.

### CLOSED RETORT.

When processing in a retort (closed-top process) with steam provide an overflow pipe connection with the bottom outlet of such a height that the steam inlet will be covered with 1 inch to 2 inches of water, thus supplying wet steam, which will not scorch or discolor the product as will dry steam under any considerable pressure. Close the bottom exhaust, lower the crates into position, close the lid and fasten the clamp or clamps opposite the hinge, then around in order, securing the clamps next the hinge last; open the top exhaust valve and turn on steam; when the steam issues freely, nearly close the top exhaust. Never entirely close this valve; leave it cracked or one spoke open. This allows the escape of gases formed and creates a certain amount of circulation of the steam in the retort. (In opening the retort reverse the above action, loosening the clamps next the hinge first and those opposite last). It is



claimed, and apparently with scientific research, experiments and results to confirm it, that if the retort is closed absolutely tight a gas or gaseous body is formed which envelopes each can, and, acting as a non-conductor of heat, prevents the full action of the steam on the contents. Open the bottom valve just sufficient to allow the condensed steam to escape. When the thermometer marks the temperature desired, take the time, then regulate the steam with valve so that this temperature is maintained. When process time is up, shut off steam, open both upper and lower exhaust valves, and when gauge shows no pressure loosen clamps, throw back lid and remove crates. If desired, a pop valve, sensitive to a half pound, set to blow off at a quarter pound more pressure than the process temperature demands, may be inserted in the lid.

Modern factories are equipped with automatic systems for controlling temperatures, and also for time of cook. These are supplied by leading thermometer makers.

#### ALTITUDE STERILIZATION TABLE.

If you are above Sea Level, determine first how high; then consult table.

Based on 29-inch Barometer with temperature at 70 degrees F. at Sea Level.

Note.—Add time in third column to the process times given in this book.

| Altitude  | Water Boils at | Additional Time |
|-----------|----------------|-----------------|
| 512 feet  | 211 degrees    | 2 minutes       |
| 1025 feet | 210 degrees    | 4 minutes       |
| 1539 feet | 209 degrees    | 6 minutes       |
| 2063 feet | 208 degrees    | 8 minutes       |
| 2589 feet | 207 degrees    | 10 minutes      |
| 3115 feet | 206 degrees    | 12 minutes      |
| 3642 feet | 205 degrees    | 14 minutes      |
| 4169 feet | 204 degrees    | 16 minutes      |
| 4697 feet | 203 degrees    | 18 minutes      |
| 5225 feet | 202 degrees    | 20 minutes      |
| 5674 feet | 201 degrees    | 22 minutes      |
| 6304 feet | 200 degrees    | 24 minutes      |

## INVESTIGATION OF THE USES OF STEAM IN THE CANNING FACTORY.

By Julian C. Smallwood, Johns Hopkins University, Baltimore, Md.  
Member of the Society.\*

(Published in *The Canning Trade* July 1 and 8, 1918.)

*This paper analyzes the different heat processes in the canning of food and points out actual and ideal steam consumptions and methods of minimizing wastes.*

It is not the writer's purpose to deal in this paper with the economies possible in the generation of steam in the canning factory. Although it would well repay the packer to inform himself on this subject, since in the boiler room any amount up to 50 per cent. of his coal may be wasted, the principles of economical boiler-room operation are well understood by mechanical engineers and are no different in the canning factory from any other. The principles and the best practice in the use of steam, on the other hand, are not common knowledge, and will, therefore, engage the writer's attention.

### USES OF STEAM IN CANNING FACTORIES.

2. First in an enumeration of the various packing-house units requiring steam are engines to turn the lineshaft and operate cranes and conveyors, and, possibly, pumps for supplying water. Next in order is the apparatus to give the raw material a preliminary heat treatment. In the case of tomatoes, this is a scalding which loosens the skins; in the case of peas, beans, spinach, etc., it is a bleacher which fixes the color of the product and washes away impurities and partial decay. At this stage some goods are placed in cans, but for others heat must first be applied in bulk in order to evaporate water and concentrate the product. For example, tomato pulp or paste must first be boiled down, as must also fruit juices in the manufacture of jellies and preserves. If the material requires such reduction, it is next introduced into a kettle supplied with a steam jacket for evaporation, or a tank supplied with steam coils, or into some form of evaporator using steam as a source of heat for evaporation. If the material does not require such reduction, it must next be sent through an exhaust box, the chief function of which is to produce a partial vacuum in the capped can by expanding its contents previous to capping. The expansion is accomplished by heating the cans by direct contact with steam in the exhaust box. After the cans are capped they are packed in metal cages and placed in a "process kettle" or retort, where they again are subjected to steam heat for the purpose of sterilizing and cooking. Finally, upon removal from the process kettles, the packed cans must have their heat removed, which is usually effected by a raw water bath and which completes the heat process of production.

### ANALYSIS OF THE HEAT DISTRIBUTION.

3. An analysis of the heat distribution leads to the following conclusions: First, as a rule, the mechanical power required is comparatively small, and this limits the possibilities of exhaust steam. Second, except

---

\*For presentation at the Spring Meeting, Worcester, Mass., June, 1918, of the American Society of Mechanical Engineers, 29 West 39th Street, New York. All papers are subject to revision.



for products that must be reduced by evaporation, the direct useful heat functions simply by elevating the temperature of the raw material from that of the room up to whatever temperature is carried in the process kettle. Assuming, for example, that the temperature of the raw material is 80 deg. fahr. and the temperature of the process kettle is 212 deg., the difference is 132 deg., and the useful heat in the whole process of canning is numerically equal to the total weight of the can contents multiplied by 132 deg. multiplied by the specific heat. To this, of course, must be added the heat of vaporization when the product is reduced, which, however, is only the case for certain products.

4. This may seem a startlingly simple conclusion to be formed from a complex problem, and yet, truly, there is no other one. Cooking and sterilizing are merely a matter of elevating a temperature and maintaining it. Once the temperature is attained it can be held, under ideal conditions, without further consumption of heat. Heat consumed for any other purpose is either for an auxiliary process or is a total loss through inefficiency of the main process. This principle finds an application in a small way, in domestic kitchens, in the fireless cooker. The old-fashioned coal stove and the more recent gas range both waste enormous amounts of heat, because after the temperature of the cooking material has been raised, heat continues to be consumed, and is wasted by radiation from the containing vessel and by convection currents.

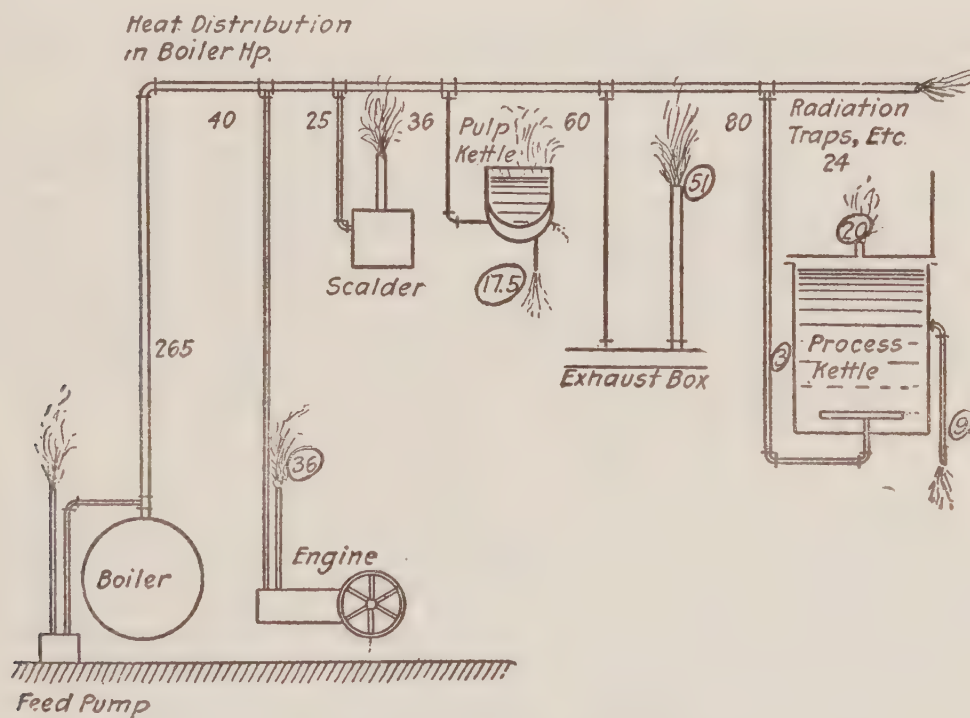

FIG. 1 TYPICAL STEAM DISTRIBUTION

5. Similarly in the canning factory, from the time the raw material enters the exhaust box up to the time it leaves the process kettle, the one desirable effect is the elevation of temperature. In the exhaust box this is partially accomplished, possibly with the expenditure of a disproportionate amount of steam. Between this stage and the process kettle the can is being capped and packed in the crates, during which handling it may radiate some heat which will have to be restored. Finally the sealed cans are placed in the process kettle. Heat is transferred to them and, incidentally, radiated from the surface of the kettle, blown right through the kettle (especially if an open water bath is used) and washed through an overflow of water.

6. For the purpose of obtaining an idea of the quantitative values of these heat transfers, Fig. 1 has been prepared, showing the distribution of heat in a packing house putting up tomatoes. An arrangement using steam inefficiently has been purposely shown in order to indicate the possibilities. It is assumed that this plant is equipped to handle 10,000 baskets per day of twelve hours, that the tomatoes are canned whole, and that skin-and-core pulp is put up as a by-product. A fair value for the yield is seven No. 3 cans of whole tomatoes per basket, and one No. 3 of pulp. This will make a total of 70,000 cans of the former and 10,000 cans of the latter per day of twelve hours.

7. Taking as the heat unit the boiler horsepower, which is equivalent to about 30 lb. of high-pressure steam per hour, or, more exactly, 33,479 B. t. u. per hour, and assuming the temperature elevation to be 132 deg., the useful heat added to the whole tomatoes amounts to 57.5 boiler h. p. The pulp must not only be elevated in temperature, but thickened by evaporation of some of its water. Assuming a reduction of 5:4, the boiler h. p. necessary is 18.5, making a total of 76.

8. Of the useful heat to the whole tomatoes only 9 boiler h. p. is added in the exhaust box, the remainder being added in the process kettle. The figures in Fig. 1 enclosed in circles represent the waste heat either through exhaust steam or hot water from drains, or radiation.

9. These heat quantities may seem excessive, but it should be remembered that they vary in each of the particulars very considerably in different plants. The distribution shown may be considered on the whole not unrepresentative.

10. A study of this example shows that there are two general methods of obtaining heat efficiency in the use of steam. First, by improvements in the construction and operation of heat-transfer apparatus, and second, by establishing a co-ordination of units so that what has ordinarily been considered as waste and irrevocable heat may be recovered to the fullest extent possible. These requirements do not exist independently. Let us then consider first the efficiency, or lack of efficiency, of the various steam-using units familiar to the canning factory, having special regard to the possibilities of eliminating steam wastes, and with all due respect to the paramount necessity of capacity.

#### BLANCHERS AND SCALDERS.

11. Blanchers and scalders both make heavy drains on the steam pressure, but they are not of such general interest as the other items listed, and may be discussed briefly. In their operation water and steam are led to a single chamber, circular or rectangular in cross-section, through which also the vegetables or fruit are fed. In blanchers the steam heats the water which is constantly overflowing, and excess steam is carried through a vent flue to the roof. Upon meeting the hot water the raw material is washed free of its gummy coating, etc., which gradually contaminates the water and necessitates a continuous supply. The incoming fresh water requires more steam to maintain the temperature. Furthermore, steam must be added in sufficient amount to counteract the cooling effect of the entering food. From these considerations it becomes apparent that an exercise of judgment is required to regulate the water and steam supply to the rate of the food material to secure the best economy with steam. The water should be fed in just fast enough to maintain the minimum degree of purity consistent with the requirements. Any greater amount of water necessitates more steam, the heat of which is wasted through the overflow. Any greater amount of steam than is necessary to maintain the temperature merely blows through the vent flue. Obviously, two or three times as much steam as is necessary may be consumed if regulation is neglected.



12. In the operation of tomato scalders, a similar conclusion may be drawn. Here the steam and water do not mix; that is, intentionally, it being the purpose to have first the steam and then the cold water strike the raw material. Steam at 80 to 100 lb. pressure is supplied through a 2-in. pipe and passes through a series of perforated holes in pipes placed above and below a conveyor chain carrying the tomatoes. The bed of fruit is something like four to six inches thick, and it is expected that these steam jets will penetrate the mass and heat their outer skins in about ten seconds. Now in the same chamber in which the steam is working, and just beyond the steam jets, are jets of cold water. There is no dividing partition, and the result is a splendid condenser effect. As the water must be kept cold, more of it than otherwise necessary is turned on to counteract this effect, thereby enhancing it. Provision is made through a vent flue so that if any steam escapes both water and tomatoes it can go out through the roof.

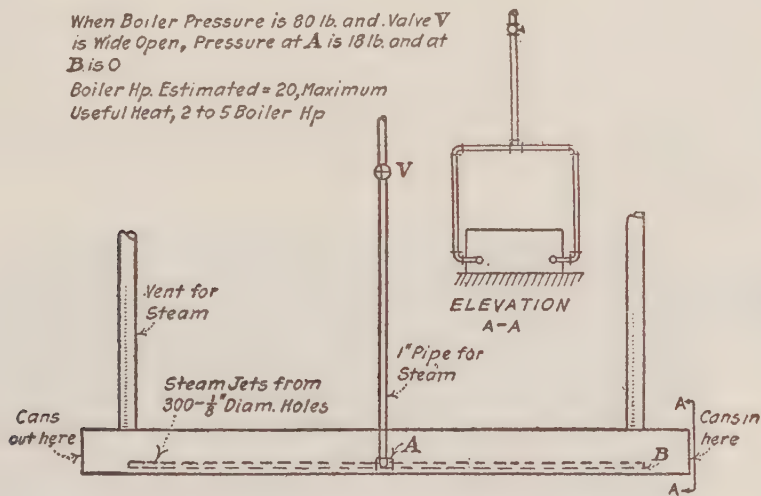

FIG. 2 EXHAUST BOX

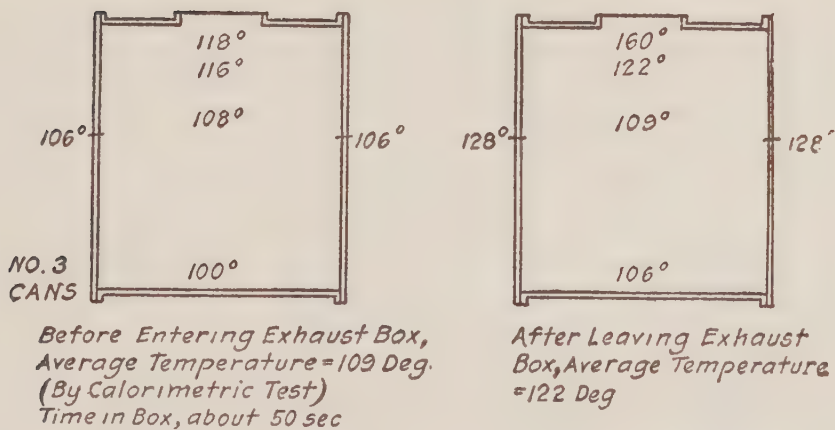

FIG. 3 TEMPERATURES ATTAINED IN EXHAUST BOX

13. Obviously, with the application of ingenuity and experiment the steam consumption of these machines might be materially lessened through radical structural changes without impairing effectiveness or capacity. On the other hand, and opposite to the case of bleachers, it is difficult to secure steam economy by nice regulation alone—for one reason because of the prejudice of operators. The writer himself has, during operation, cut down the steam valves on scalders from full opening to one-half turn, and the

girls peeling the tomatoes never knew the difference. But once let them know that the steam is reduced, and they will insist that the tomatoes are not scalded enough!

14. Another instance of the effectiveness of supervision: Tomatoes are dumped from baskets on to the conveyor leading to the scalding by two untutored negroes. Due to the lapses between baskets, the conveyor chain travels 5 ft., then receives a charge, then another idle 5 ft., and so on. Each basketful forms a small pyramid, 8 to 10 in. deep at the apex. The tomatoes on the outside are scalded sufficiently, but those at the thick part of the mass hardly at all, whereupon the girls handling the latter demand more steam. By the simple expedient of having the tomatoes distributed on the conveyor chain in an approximately uniformly thick bed, about 50 per cent. of steam is saved.

#### EXHAUST BOXES.

15. Exhaust boxes are now to be considered. In the home-made form (see Fig. 2) these are long rectangular boxes made of four planks, open at the ends, and through which a conveyor chain passes bearing the filled but uncovered cans. Drilled pipes within the box are used as steam jets playing on the cans. At the ends of the box are flues, so that when the steam is fully turned on it will not pass into the packing room, but out through the roof.



16. It is at once apparent that it is out of the question to obtain anything like a uniform temperature of the can contents in the small space of time that they are subjected to the steam, particularly if they are packed so closely and contain little liquor. Fig. 3 shows the results of some temperature measurements made by inserting a thermometer at different points. The average temperatures were obtained by calorimetric determination. It is thus seen that although it is the intention to elevate the temperature of the cans to about 160 deg., nothing like this is accomplished. If it were, the original temperature being about 100 deg., the useful heat (that is, heat actually transferred to the cans) would be 16 boiler h. p. for the conditions shown in Fig. 1. Actually, the useful heat is only 2 to 5 boiler h. p. (corresponding to temperature ranges of from 5 to 20 deg.). In Fig. 1 a temperature rise from 80 deg. to 120 deg. is assumed. The heat consumed in the form of steam may be as much as anything between 20 and 30 boiler h. p., making for a thermal efficiency of about 10 to 15 per cent. Where does the difference go? Through the roof.

17. The performance of the exhaust box as regards steam economy may be materially bettered by the careful regulation of the steam supply. From trials which the writer has made, involving temperature and pressure measurements, he has found that the steam can be cut down from full on to about one-half a turn of the stop valve in some cases without materially affecting the temperature elevation. That is, the heating effect is nearly as good when the steam merely trickles through as when it pours through. To gain effectiveness, the time during which each can is subjected to the



steam must be lengthened, and the greater the time, the greater will be the machine's efficiency. This fact is being recognized by the manufacturers of modern forms of exhaust box, which are so shaped that the length of the path through them is greatly increased, thereby increasing the time of heating (to 5 and 15 min.). Such a box is shown in Fig. 4.

18. Much can be gained if the exhaust box is in part relieved of its effort by introducing whatever liquid goes with the solid part of the contents as hot as possible. As previously mentioned, after the solid material is placed in the can, either by machine or hand, liquor is added either in the form of brine, syrup or fruit juice. This liquor is previously heated, but between its heating and the time of introduction into the can it often is allowed to cool, either by halts in the procedure or through radiation from pipes and containing vessels. In every case the liquor should enter the can at about 210 deg., which high temperature may so elevate the average temperature of the packed material, especially in hot weather when the initial temperature of the solid is high, as to make the additional elevation by the exhaust box trifling.

#### JACKETED KETTLES.

19. Turning now to a consideration of the various packing-house units used for concentrating liquid foods and food juices, which units may be termed generally "evaporators," it will be noted that there are many different forms and types. Perhaps the most elementary form, and in some ways the most interesting, is the jacketed kettle (see Fig. 5). In shape this is the same sort of utensil as the old-time housewife used, but, of course, is larger, having a capacity of between 50 and 500 gal. It receives its heat from the steam jacket whence it gets its name. The jacket is tapped with one or more openings to receive the steam pipes and another opening for the drain pipe to carry off the condensed steam.

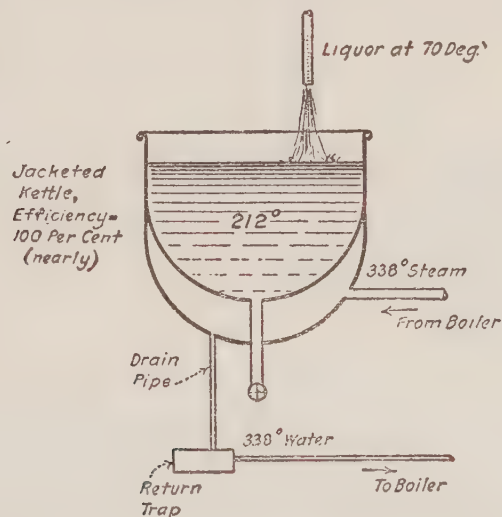

FIG. 5 HEAT TRANSFER IN JACKET KETTLE

20. The performance of these kettles is very interesting in many ways. In the first place, it may be observed that under approximately ideal conditions their thermal efficiency may be nearly 100 per cent, the only loss being from radiation of heat from the outside of the jacket. This assumes that the condensate from the jacket is returned to the boiler through a return trap, which, however, is not always—or even often—used. Steam at 100 lb gage pressure has a temperature of 338 deg., so if steam of this pressure is used in the jacket of a kettle, it will, after condensing in the jacket, emerge from the drain pipe as water at 338 deg. If this hot water

is returned to the boiler by a return trap, none of the heat is lost (except that small amount due to radiation), and practically all of the heat given up by the steam goes to the useful purpose of evaporating water from food material.

21. There are, however, three other ways in which steam may be handled (see Fig. 6). First, the drain may be passed through an atmospheric trap, which necessitates that the water be reduced to below 212 deg. before it can be returned to the boiler. In this case the efficiency of the system is 87 per cent., and 13 per cent. of the heat consumed is wasted. Practically the same thing may be accomplished if the drain pipe is without a trap, but is supplied with a stop valve so regulated that only water will be discharged. Second, the kettle may be supplied with an atmospheric trap, or a stop valve in the drain pipe as just described, the discharge from which is not returned to the boiler. In this case, if feedwater at 70 deg. is used to make up the 212-deg. water which might have been used, the waste is 24 per cent., and the efficiency only 76 per cent. Third, the kettle may be unprovided with a trap of any kind, and the valve in the drain pipe left so wide open as to let large quantities of steam escape as well as condensate. Here it is difficult to estimate the ensuing waste, but if one is to judge by the ascending clouds of steam, it must be enormous.

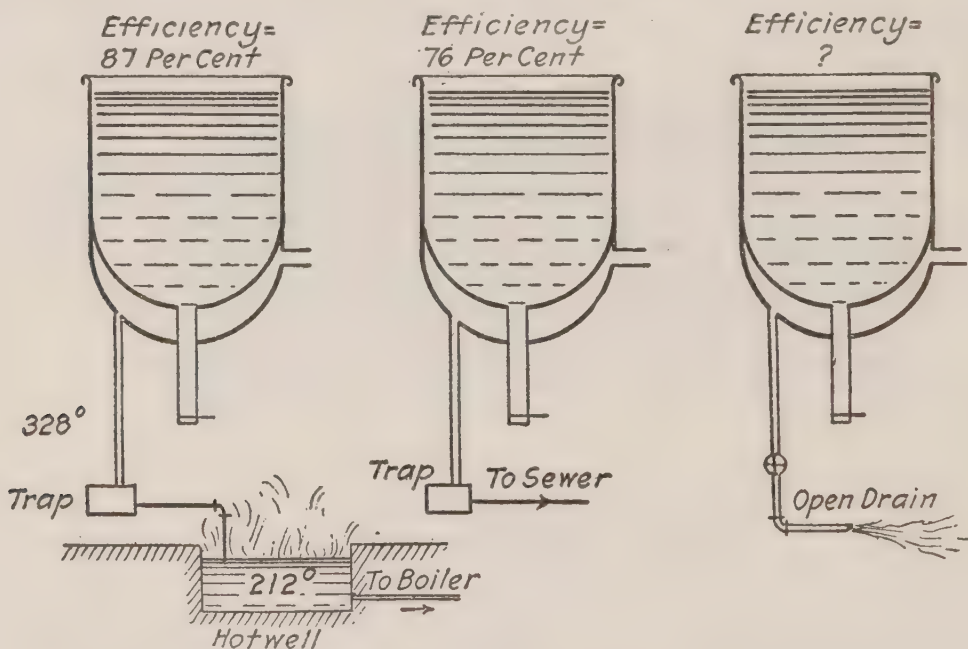

FIG. 6. DRAINAGE SYSTEMS FOR JACKETED KETTLES

22. Many operators of these and other steam-using units in the canning factory labor under the delusion that a violent commotion and an ear-splitting racket are evidences of rapidity. Hence they will turn on the steam until their eyes and ears are satisfied in these respects. Unless means are taken to prevent such excesses through traps and other food-proof devices, it is impossible to eliminate wastes.

23. Before leaving the subject of jacketed kettles, a word must be said about their performance as regards capacity. Judged as an evaporator suitable for high rates of evaporation, it would seem, offhand, that nothing could be cruder. There is absolutely no provision made for systematic circulation of the kettle contents, which matter of circulation is given most careful thought in the design of steam boilers. A jacketed kettle in full blast shows the most haphazard ebullition, and one would suppose that a much more effective rate of evaporation could be obtained if the circulation could be assisted. In spite of this, the fact is that this apparatus is a remark-



ably quick evaporator. Results that have come to the writer's attention show, with the use of 100-lb. steam, as high as 8.5 gal. or 70 lb. of liquid evaporated per square foot per hour after the mass has come to a boil. This corresponds to about 700 B.t.u. of heat transferred per hour per square foot per degree difference of temperature, a figure comparing very favorably with the best types of feedwater heaters and condensers, which class of steam-engineering apparatus the jacketed kettle most closely resembles as regards heat transfer.

24. Jacketed kettles differently installed show very different capacities for evaporation. The question then arises: What are the factors affecting the rate of evaporation? A study of this question shows that the total amount of water a kettle can evaporate per hour may be affected chiefly by the pressure of the steam in the jacket. The rate of heat transfer is directly proportional to the difference in temperature between the boiling material (about 212 deg.) and the substance supplying the heat, that is, the steam. Now, since the temperature of steam increases with its pressure, the high-pressure steam is more effective in rapidity. But if the steam pipes are too small, or if the kettle opening for steam is not large enough, there may be a considerable drop of pressure of the steam before it reaches the jacket, and a still further drop after it gets into the jacket. In consequence, and especially if the steam is initially wet, it falls in temperature and loses some of its effectiveness. In this connection it is appropriate to remark upon the prevalent packing-house custom of economizing on pipe sizes. A kettle with a bushed steam opening cannot evaporate as fast as one with an unrestricted supply. Even under the best conditions it is a matter for speculation whether or not the steam pressure in the jacket is not materially less than that in the steam pipe because of the condenser effect of the comparatively cool liquid within the kettle. At all events, much can be done to improve capacity by using carefully calculated pipe sizes, and by introducing the steam into the jacket through two or more openings instead of only one. A series of experiments with the purpose of learning the pressure within a steam jacket for different systems of piping would, it is felt, disclose facts of practical value in future design.

25. The capacity of a jacketed kettle may be much reduced by the cooking material caking to its sides. To avoid this condition, kettles are frequently equipped with mechanical stirrers, which continuously wipe the heating surface, thus keeping it clean. This action also imparts a velocity to the boiling liquid at the heating surface, which, presumably, affects the heat transfer, but just how much is not known. Similarly, the quantitative effect of high velocity of the steam in the jacket is unknown.

#### COIL EVAPORATORS.

26. The final limitation to capacity has to do with the area of heating surface. In this respect the jacketed kettle bears about the same relation to evaporators of refined design, such as the vacuum pans, as the first shell boiler to present-day water-tube boilers; that is, it is deficient in heating surface. The obvious step, then, is to add heating surface in order to increase capacity, and this has been done. The additional surface takes the form of basket or ring coils, or nests of tubes, whereby the heating surface can be tremendously increased. There is, however, an undetermined limit to the effectiveness of such additions, since they may retard the circulation of the boiling material to such an extent as to decrease instead of increase capacity.

27. Coils offer such an attractive way of forming a compact heating surface that they have come into favor in units which dispense entirely with the steam jacket. Any form of containing vessel may be used for the liquid to be concentrated, and the vessel may be made of any appropriate

material. Jacketed kettles are commonly made of copper; the containing vessels for coil evaporators may be made of wood, thereby making a great saving of expense. Also, a modern wooden vessel with coils occupying a given floor space may contain vastly more heating surface than a jacketed kettle occupying the same floor space, and therefore have considerably greater capacity. In such a case the coil evaporator also loses less heat by radiation from the containing shell, but otherwise the heat efficiency of the coil may be just as good or as bad as that of jacketed kettles previously cited. The effectiveness of a single square foot of heating surface of the coil is, it is believed, possibly less than that of the jacket, particularly if the coil is not carefully designed. "Effectiveness" in this connection means the number of heat units that can be transferred per hour from the steam to the liquid contents. As mentioned before, the efficiency may be nearly 100 per cent. in each case.

28. Evaporators depending upon coils or nests of tubes suffer two serious disadvantages: First, they are much more difficult to clean and to keep clean than are jacketed kettles. Mechanical wipers, as stirrers, are out of the question, and hand cleaning is awkward. Second, they are, with poor design, more apt to leak steam into the liquid to be evaporated than are jackets, whereby both heat and capacity are lost.

#### VACUUM PANS.

29. In the writer's opinion a type of evaporator which will eventually enter the canning factory is the vacuum pan, Fig 8. The advantage which it possesses is that it can use exhaust steam efficiently, and, when live steam is employed the pan may be so designed as to take only half or less than half the steam required by apparatus which boils at atmospheric pressure.

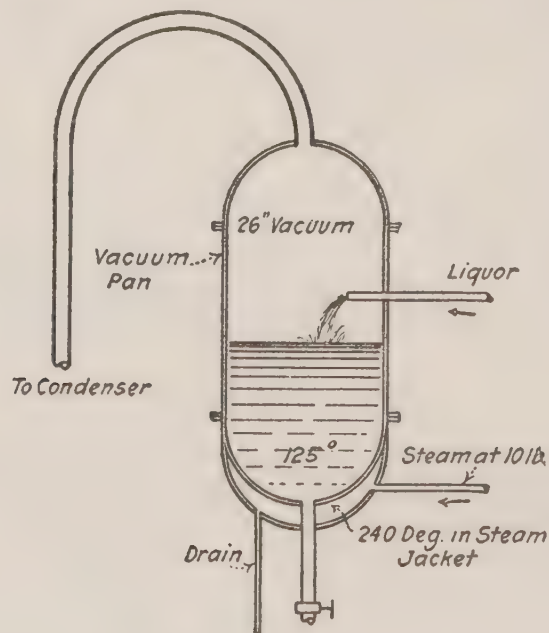

FIG. 8 VACUUM PAN

30. The subject of vacuum pans is too large a one to enter upon here, there being many different designs and principles involved. It may be mentioned, however, that the whole subject is replete with unsolved problems which give much opportunity for successful research work.

31. All of the evaporators cited may meet a check in their capacity when certain products are handled, through the thickening and foaming of



TABLE 2—COMPARISON OF HEATING-SURFACE REQUIREMENTS OF KETTLES AND COILS.

|                                                           |      |      |      |       |
|-----------------------------------------------------------|------|------|------|-------|
| Capacity of kettle, gal.....                              | 100  | 300  | 500  | *600  |
| Heating surface per gal. of contents,<br>square foot..... | 0.10 | 0.08 | 0.06 | 0.083 |

\*Tank with coil.

these products. To avoid boiling over, foaming necessitates a cutting down of the rate of evaporation. Similarly with thickening—the resulting increased viscosity of the mass causes a spattering dangerous to operators and wasteful of material. In such cases the initial rate of evaporation must be lessened toward the end of the process. The remedy is evaporators with high sides to prevent boiling over, and stirrers to prevent caking.

32. Another item which should be carefully calculated for individual evaporators as well as a number of them together, is the drainage of the spaces supplying steam. It is very easily possible to flood these spaces with water, either through too small a pipe size for the drain from the jacket or coil, or by having one unit flood another, or by a badly damaged unit of which coils are a conspicuous example.

TABLE I PERFORMANCE OF EVAPORATORS

| Type of evaporator                                                                         | Evaporation,<br>lb. per sq. ft.<br>per hr. | B.t.u. trans-<br>f'r'd per sq. ft.<br>per hr. per<br>deg. fahr.<br>difference<br>in tempera-<br>ture |
|--------------------------------------------------------------------------------------------|--------------------------------------------|------------------------------------------------------------------------------------------------------|
| Jacketed kettle with 100 lb. steam pressure by test .....                                  | 66.6                                       | 660                                                                                                  |
| Jacketed kettle with 50 lb. steam pressure, assuming the same B.t.u. rate of transfer..... | 45.0                                       | ....                                                                                                 |
| Jacketed kettle with 25 lb. steam pressure.....                                            | 29.0                                       | ....                                                                                                 |
| Shell evaporator, with paddles, 50 lb. steam pressure, by test .....                       | 41.5                                       | 625                                                                                                  |
| Coils, 100 lb. steam pressure, by test.....                                                | 60.0                                       | 628                                                                                                  |
| Vacuum pan, single effect, 25 lb. steam pressure, on tomato paste; average, by test.....   | 40.0                                       | 313                                                                                                  |
| Vacuum pan, maximum, 100 lb. steam pressure...                                             | 105.0                                      | 600                                                                                                  |
| Vacuum pan, with 10 lb. steam pressure, single effect, and 26 in. vacuum.....              | 64.5                                       | 600                                                                                                  |

COMPARATIVE PERFORMANCE OF EVAPORATORS

33. Table I shows the comparative performance of these various evaporators. It should be remembered upon considering the results indicated in this table that the data have been obtained for the most part under packing-house conditions and that the results should not be considered as exact, especially in view of the fact that they were obtained from only a few tests. They may, however, be considered as conservative, since other tests, the results of which have been brought to the writer's attention, show considerably higher values, particularly in the case of jacketed kettles; values so high, in fact, that he hesitates to quote them.

34. In Table I the first three lines show the effect of using steam of a lower pressure than 100 lb., the rate of evaporation in pounds per square foot per hour rapidly falling off with the lower-pressure steam. The low result of the shell evaporator may be explained possibly by the effect of the design, in that the heating surface was so arranged that part of it could

be flooded during operation. It is seen from the table that the best results were secured with the jacketed kettle. This fact is very much influenced by the steam connections, in that if only one is used the rate of evaporation may be only half that which is obtained when two generous steam openings are employed.

35. Table 2 is intended to show the real advantage of coils. The figures presented are obtained from a number of kettles and coils in actual operation. It is seen that as the capacity of the kettle increases, the heating surface per unit of contents decreases, which is not true of the coil, the reason being that the jacket surface of the kettle increases with the square of its linear dimension, whereas the volume increases as the cube.

#### PROCESS KETTLES.

36. The last item to be considered is the process kettle. In one way this is perhaps the most important of all, since the success of the pack depends upon the process kettle. Its whole function is to raise the temperature of the contents of the cans to that necessary for sterilization. Fig. 9 is a diagrammatic representation of a process kettle.

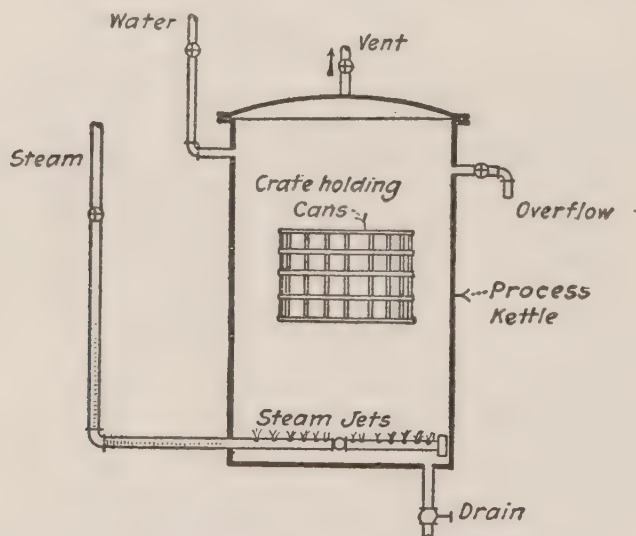

FIG. 9 PROCESS KETTLE

37. There are four methods in use in the operation of these units: First, the cans are placed in the process kettle, which is previously empty; the kettle is then closed and steam turned on so that a pressure of between 5 and 15 lb. gage is secured. Second, this same process may be used, except that the kettle is previously filled with hot water and the cans are subjected to a water bath under pressure at a correspondingly high temperature. Third, the cans may be placed in a closed process kettle and subjected to a pressure very slightly greater than atmosphere, say, 1 lb. gage, there being no water in the kettle. Fourth, the process may be under atmospheric pressure, but in a water bath with the lid of the kettle raised. These processes may be referred to as dry and wet, respectively, and closed and open.

38. In the open-bath process it is a custom of operators to maintain a violent boil of the bath so as to secure a circulation through all the interstices between the cans, which practice results in large volumes of steam being emitted into the packing room. In the closed process it is the custom to vent the valve on top of the kettle. When the process is wet, it seems that the object is two-fold: first to secure a circulation through the interstices, and



second, because it is easier to maintain a uniform temperature with the steam flowing through rapidly with this vent valve considerably open than to secure this uniform temperature with only a small vent.

39. Now, besides raising the temperatures of the cans, in the dry process heat has to be furnished to the kettle in the following directions, all of which is wasted:

- a To raise temperature of the metal of crates and kettle
- b To vent the kettle, allowing air to escape, or to establish a circulation through the cans
- c Condensed steam drained from kettle
- d Radiation of heat from the outside surface of the kettle.

To these items must be added, when the wet process is used, the heat necessary to raise the temperature of a mass of water as well as that of the cans. Table 3 gives some quantitative values, obtained in part by test, but for the most part by calculation upon the assumption of reasonably good conditions in each item. In this connection it should be remembered that radiation, venting and overflow wastes may each vary widely with different operators and units.

TABLE 3 AMOUNT OF HEAT (B.T.U.) REQUIRED FOR PROCESSING IN ONE KETTLE 40 INCHES IN DIAMETER BY 72 INCHES DEEP.

|                             | ½-hr. closed process at 240 deg. fahr. |                | 1-hr. open process |                |
|-----------------------------|----------------------------------------|----------------|--------------------|----------------|
|                             | Dry.                                   | Wet.           | Dry, 216 deg.      | Wet, 212 deg.  |
| To cans, from 120 deg.....  | 198,000                                | 198,000        | 158,000            | 152,000        |
| To water, from 212 deg..... | 0                                      | 28,000         | 0                  | 0 (?)          |
| To metal, from 212 deg..... | 3,300                                  | 3,300          | 500                | 0              |
| To vent on top.....         | 0+                                     | 17,500         | 0+                 | 35,000+        |
| Radiation .....             | 9,000                                  | 9,000          | 15,300             | 14,800         |
| Overflow, or drain.....     | 38,000                                 | 46,000         | 26,000             | 29,300         |
| <b>Total B.t.u.....</b>     | <b>248,300</b>                         | <b>301,800</b> | <b>199,800</b>     | <b>231,100</b> |
| <b>Boiler hp.....</b>       | <b>14.8</b>                            | <b>18.0</b>    | <b>6.00</b>        | <b>6.90</b>    |

40. In studying the data presented in Table 3 it should be remembered that the calculations depend largely upon assumptions which are only approximately true, and furthermore that the conditions may vary widely so as to alter the figures: They show, however, what may be taken as a reasonably representative comparison. The first item, namely, the heat added to cans, assumes that the average temperature of the cans leaving the exhaust box is 120 deg.; the actual temperature may be greater or less than this. The further assumption is made that the contents of the cans are raised from this initial temperature up to the temperature of the process. Actually, the temperature of the process may be attained on the outside layers of the can, but this gradually merges to a lower temperature at the center, so that the average temperature at the finish of the process is something less than 240 deg. in the closed process and less than 216 deg. in the open. The second item, having to do with the heat added to the water in the wet process, assumes this water to be at 212 deg. It may, however, be cooler if there is much time between batches, allowing cooling, or if the operators introduce a large volume of cold water in the kettle to reduce the temperature quickly.

41. The same reasoning applies to the heat added to the metal of the process kettle and crates. The amount of steam vented from the top of the kettle may vary considerably according to the custom of the operator. From

tests made by the writer, with the closed process it amounts to the equivalent of 1 boiler h. p. under the manipulation of a fairly good operator. The radiation loss is less in total for the closed process than for the wet, since this is quicker, but the loss per square foot per hour is higher for the closed process, since the temperature difference is higher. The overflow or the drain loss may be much larger than quoted in the case of careless manipulation. It will be seen that the open process at 216 deg. is the most economical in the use of steam. Comparing the boiler h. p. required for the different systems, it is noticed that the closed wet process takes about three times as much steam as the dry at 216 deg. On the other hand, the former is capable of twice the capacity of the latter, so that the proportion of steam per can is as 3 is to 2.

42. Efforts have been made to increase the capacity of process kettles by agitating the cans during cooking, machines for this purpose being styled "continuous cookers."

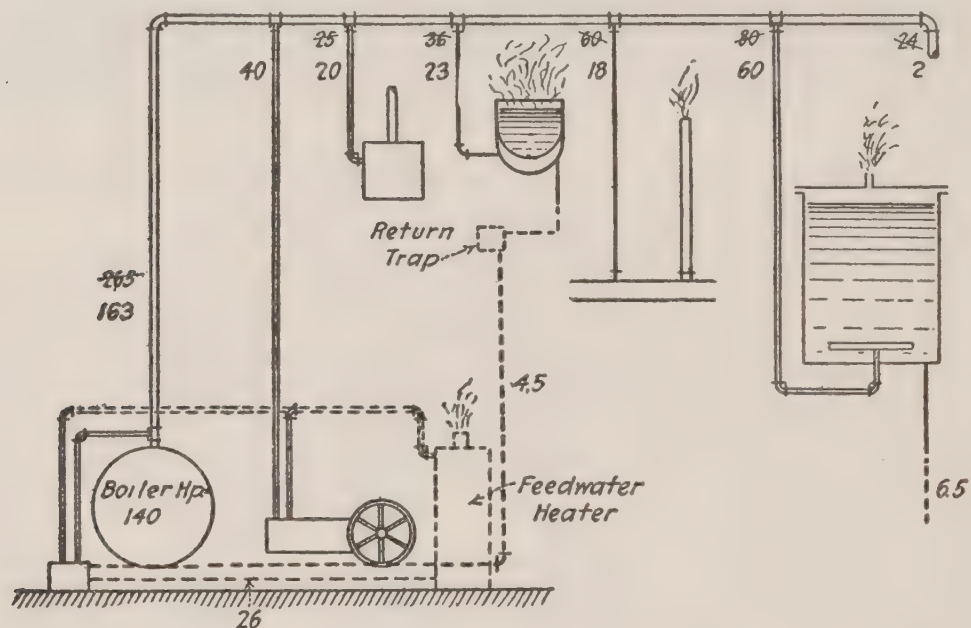

FIG. 11 IMPROVED STEAM DISTRIBUTION

43. There seems to be ample field for enlightenment by experiment in the case of process kettles. Among the questions to be answered are: What are the times necessary to elevate the temperature of the center of a can under the open or closed systems, and how much difference is made by circulating water instead of steam upon the time? What effect has venting the kettle different amounts? What effect has agitating the cans? If such venting of the kettles has any favorable effect, how may the steam thus lost be recovered? How does the temperature of the cans at various parts of the kettle vary: Of what value are automatic regulators to steam economy?

POSSIBILITIES OF IMPROVING PERFORMANCE OF PLANT.

44. Referring to Fig. 11, the possibilities of bettering the performance indicated by Fig. 1 are shown. The consumption of the scalding is reduced from 25 to 20 boiler h. p. by careful supervision of its performance. The efficiency of the jacketed kettle is improved by means of the return trap which passes back to the boiler  $4\frac{1}{2}$  boiler h. p., thereby eliminating all possibility of waste in steam through the drain. The exhaust box is increased in efficiency to 50 per cent., and very probably much better than this can be secured with the more modern forms of exhaust box, the loss then largely being due to



radiation. By using the dry process at 216 deg. the process kettle loses heat only through radiation in amount equal to about 5 boiler h. p. and through condensate form the drain equal to about  $6\frac{1}{2}$  boiler h. p., the loss through the vent with automatic regulation being negligible. It is questionable how the  $6\frac{1}{2}$  boiler h. p. escaping from the drain may be utilized. It might be returned to the boiler as feed if provision were made to eliminate impurities. An exhaust steam feedwater heater is added, by means of which 26 boiler h. p. is recovered, but as the exhaust steam is in excess of the requirements for preheating the feed water, some of that available from the engine is lost through the vent. It is very possible that this excess of steam should be recovered in one of the steam-using units; for example, if a process kettle were designed with sufficiently large steam pipes and openings, exhaust steam could be used in it, or this exhaust steam could be used in a vacuum pan. There are a number of such possibilities.

#### GENERAL CONSIDERATION.

45. Having now taken up in more or less detail the various familiar steam-using units in the canning factory, the writer would conclude with a few remarks of general application. Economy in steam means three things—increasing efficiency of units, eliminating all avoidable wastes, and utilizing all other wastes of heat as by-products. The first two can only be accomplished through measurement—it is necessary to know how much steam is used and wasted. The packing house should be properly equipped with measuring instruments for this purpose. The familiar and little appreciated pressure gage is almost a stranger in the packing house, and yet a judicious use of this instrument will disclose much valuable information as to how steam is being used or abused. To find out how low the steam pressure is on some units whose inefficiency or lack of capacity has been ascribed to other causes and inspired futile remedies, will open the eyes of the superintendent. Next, when we eliminate wastes, we must eliminate *all wastes*, and not tolerate any just because we have been accustomed to seeing them and know that they are difficult to avoid. Wherever steam shows in the atmosphere is represents a waste, whether the steam comes from the jacket of a kettle, the vent of a process retort, the flue from an exhaust box or heater or scalded, or from any cause whatsoever. We have no right to discharge steam into the atmosphere, even if it is exhaust steam. We have no right to radiate heat to the atmosphere which might be caved by non-heat-conducting protection, and such wastes, it is necessary to say, are wantonly committed in the packing house. No steam-using units the writer has seen in such houses make the slightest provision against loss of heat by radiation. This is not only a waste of coal, but a waste of human energy, since the operators cannot work efficiently in the torrid heat usually prevailing and aggravated by radiation from steam-using units. The packer objects on the ground of expense, but he should remember that each square foot of surface with steam behind it radiates to the atmosphere in ten hours an amount of heat requiring the burning of one pound of present-day coal, and then, upon calculating what this aggregates to, will he realize that it is not a question of the expense of installing pipe coverings and other similar devices, but the expense of not doing so.

46. Finally, the question of how to utilize by-product heat requires careful study. In each factory the problem may be different, and in each it may be a separate case of proportioning the units to fit into each other. Feedwater heaters, traps, low-pressure heaters—all should be considered. Even the water used for cooling the cans, which carries away all of the useful heat transmitted, as previously defined, may be made to render up some of the heat it has removed.

### WATER AND STEAM PROCESS.

When processing in a retort with water and steam, close bottom outlet and fill retort half full of water; bring to a boil; shut off steam and place crates; then handle same as with steam, of course keeping bottom outlet closed.

### TESTING GOODS.

Self-registering can-testing thermometers are valuable aids in determining when goods have reached the sterilization point, and are especially valuable for dry-packed corn, which should be tested, if not every batch, at least several times a day. When testing articles packed in either brine or syrup, remember that the thermometer marks the temperature of the surrounding liquid and not the internal temperature of the fruit or vegetable; consequently, good judgment is required in reducing process time, particularly so when goods are cooled, as they always should be, after processing. It is advised that frequent tests be made of the temperature attained during processing, and probably the best and most economical device yet placed on the market is the Self-Registering, Sterilizing Thermometer. These thermometers are fitted to metal caps (as shown on page 54) which are soldered to the regular tin cans, and may be used almost indefinitely by replacing the tins which may become bent, misshapen or rusted from constant use. Cut cans frequently, noting cook, color, weight and general appearance of goods.

### PROCESSING GLASS.

Glass jars are used principally for high-grade products—jams, preserves, jellies, etc.—and are best processed in water at 212 degrees or in steam at a temperature not much in excess of this point. During cold weather temper all glassware before filling, and it is customary to fill with hot liquid instead of exhausting, though they may be exhausted in hot water or steam, but preferably the latter at about 175° F. After making closure, place in water of about same temperature as contents of package; bring very slowly to a boil; take time; when process time expires, turn off steam and allow the water in kettle to cool about to 189 degrees before removing jars. Be careful not to expose the hot jars to a current of cold air, as this will cause excessive breakage. Under favorable conditions a loss of less than 1 per cent. may be expected from breakage in processing and cooling glass goods. Glass may be processed in steam in an ordinary steam exhaust box, or in an extra long continuous steam exhaust box run at the proper speed. Bring the heat up very slowly and cool very slowly



## STERILIZATION—IMPORTANCE OF PROPER PROCESSING.

(Reprinted from THE CANNING TRADE, Issue of January 20, 1911.)

*Note.*—In this article the terms “retort” and “kettle” are used synonymously since the subject deals with the treatment of canned foods in closed vessels under pressure.

Assuming that all who are engaged in the canning business are familiar with the basic principles of processing, this article will deal only with the methods by which processing can be made an easier and surer operation by the use of modern and up-to-date appliances that make automatic the operations on which scientific processing depends and which cannot be perfectly carried on while relying altogether on manual labor and human intelligence.

If a constant boiler pressure could be maintained at all times and a perfect steam circulation be produced in the kettles a careful processor could, by constant attention, hold the kettles at a fairly uniform temperature. But since these two ideal conditions are rarely found in a canning plant, what can be done to improve them?

Owing to the variable demands for steam pressure, it is almost, if not utterly, impossible to keep a steady boiler pressure, but the conditions in the boiler-room can be improved by employing a first-class engineer and modern power plant equipment.

*Circulation in the kettles.*—If processing altogether with steam, good circulation is assured by placing a vent in the cover so that a steady stream of steam escapes when the kettle is closed and under pressure. The thermometer pocket should also have a vent to insure perfect circulation around the thermometer bulb, otherwise the instrument cannot give true indications of the temperature existing inside of the kettle.

If cooking in a closed kettle with water heated by live steam, obtaining perfect circulation is more difficult than where dry steam only is used.

In order to produce a uniform pack, it stands to reason that every can in every batch must be exposed to the same temperature for the full cooking period. If this is not done, some of the cans will be either over-cooked or under-cooked. If undercooked, “swells” will result, because the bacteria, which are always present in food of any kind, have not been destroyed; if over-cooked, the goods will either be discolored or lose their firmness and cannot be classed as first quality or standards.

To obtain this uniform temperature then, in waterbath process, it is essential that the best possible circulation be produced and maintained, and this can be accomplished by the use of a simple but effectual circulating system, which is illustrated by Fig. 1.

By means of the three circulating pipes “D” and the suction created by the force of the steam passing through the jet “C,” a rapid circulation takes place, which causes the water in the kettle to flow out the circulating pipes at “A” and into the kettle again at “B.” As a result of this constant passage and repassage of the water through a kettle, the water is thoroughly mixed and the cans are sure to be exposed to the same temperature, regardless of their location in the kettle. The use of “telltale” can-testing thermometers placed in cans in different parts of the crates will give positive information regarding the temperature to which the goods have been exposed, because each thermometer will register the maximum temperature to which its particular can has been subjected during the cook.

The next step is to control the flow of steam into the retort so that a constant temperature may be maintained. When this is done, by having a man pass up and down the line of kettles, watching the thermometers and adjusting the hand valve according as the temperature has increased or de-

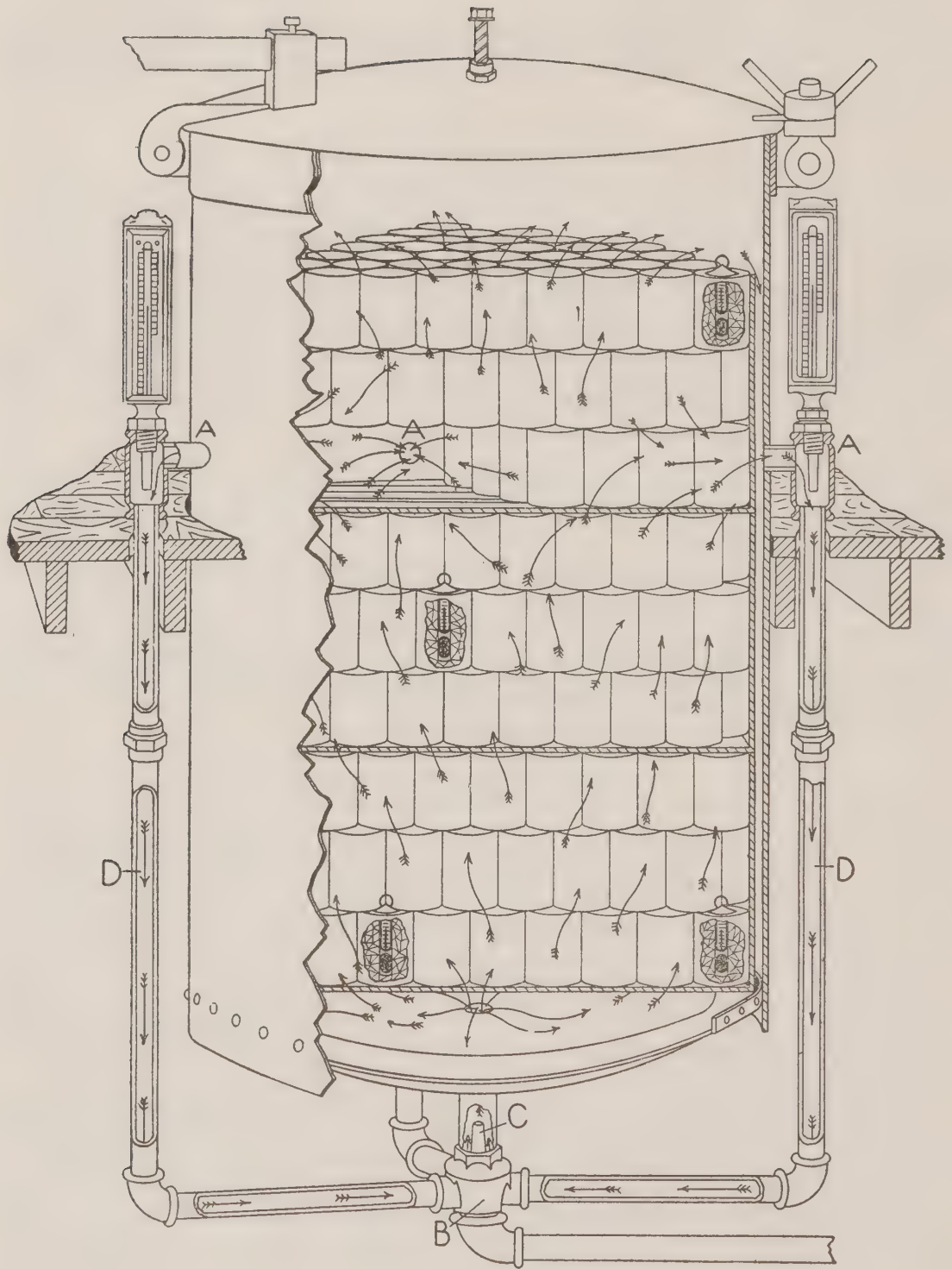

Figure I.



creased, the same risks are taken which would be assumed in a boiler plant if, instead of placing safety valves on the boiler, the engineer was wholly depended on to hold the pressure at the right point by constantly watching the gauge.

You may employ the best processor obtainable, but since he is human, you run grave risks so long as you depend entirely on his endurance to do this work for you. During the busy season he is often obliged to work night as well as day, and he cannot give the attention to his work that he ought.

To overcome this difficulty and to reduce to a minimum all chances of loss due to improper control of the steam entering the retort, there exist various automatic or mechanical processing devices.

Two systems of automatic retort control are in use. One, known as the individual retort control, and the other known as the battery control. The former requires that every kettle or retort have its own individual regulator, thus making each regulator independent of every other. The battery control consists of but a single regulator, which is equipped to control the entire battery as a unit. It will be seen, therefore, that in cooking different kinds of goods at various temperatures in the different kettles of a battery, the regulator for battery control cannot be used and the individual regulator is essential.

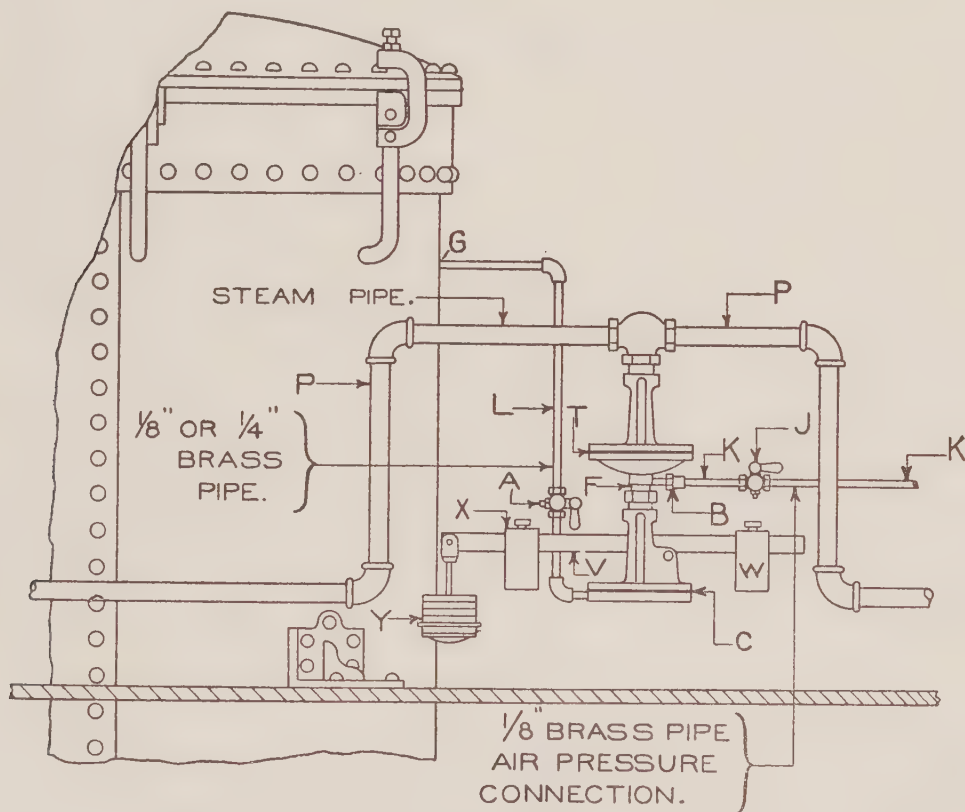

Figure II.

Aside from this, if the regulator for battery control is in operation and anything goes wrong which requires shutting down the regulator, the whole battery is without the use of automatic service.

If, however, the kettles are equipped with individual regulators and it is found necessary to cut off one of the devices, the only kettle affected will be the one whose regulator is shut down. This kettle can then be operated by hand and the others will continue to run automatically.

Since the cost of both systems is about the same, the demand for the individual for each retort seems predominant, owing mainly to the objections to the battery control which are stated above.

As the individual regulator is in more general use, it will be described and illustrated in preference to the other. Fig. 3 illustrates this form. Its operation is reliable and its construction is simple. The principle by which it works is a counterbalance of steam pressure by adjustable weights. The motive power by which these regulators are operated is compressed air, and if a plant is not equipped with this, air compressors can be obtained of sufficient capacity to operate as many regulators as the plant is utilizing.

The regulator is suspended from the steam pipe which feeds directly into the retort or kettle. Small brass pipe is run into the retort or kettle and connected to the regulator at point "G." From the air compressor  $\frac{1}{8}$ -inch brass pipe is run and connected to the regulator at "B." By means of the sliding weights "X" and "W" and the hanging weight "Y," the regulator can be adjusted to the smallest fraction of a pound. At the point "C" is a flexible diaphragm, which the steam from the retort, through pipe "L," tends to raise. The weights, having been properly adjusted for the temperature at which it is desired to control, prevent the steam from lifting the diaphragm until it exceeds by the smallest fraction of a pound the pressure which the regulator is set for.

When the steam pressure does increase sufficiently to lift the weights by means of the diaphragm "C," a valve is immediately opened at the point "F" and the air pressure coming into the regulator at "K," at once inflates another diaphragm at point "T," which instantly shuts off the steam supply at the retort or kettle. The pressure inside of the retort then falls, and as a result the weights on the lever arm force the diaphragm "C" back into place, the valve at "F" drops back, cuts off the air supply, and the diaphragm "T," being forced back into its original position, allows the steam pressure to enter the retort again. This regulator is so sensitive that, by watching the thermometer, it will be noted that the changes in temperature are so slight as to be imperceptible. By increasing or decreasing the weights "Y" and by use of the sliding weight "X" it is possible to control at any pressure desired.

Some of the very largest canning plants in the country are equipped with these mechanical processors, and the reports coming from those who use them state that not only is risk and worry avoided by their use, but that far closer control is obtainable than could ever be hoped for from the old method of hand control. Aside from these facts, the saving of steam is considerable, as well as the saving of help. With the old method the man doing the processing was obliged to put practically all of his time at this work; but, with the use of regulators, it is possible to make his time valuable in other departments.

## COOLING.

After crates are removed from process kettles, immediately drop them into a tank of running cold water to "kill" the live heat and prevent a secondary cooking, which injures color, flavor and appearance of goods. Cooling tanks may be constructed of any suitable material and of any desired shape. Long tanks through which the crates may be conveyed by means of an endless chain, or a simple round tank in which the crates may be dropped, or if not provided with suitable tanks, the crates may be set on the floor and the cold water applied by means of a hose. The method does not matter so long as the object is attained. The cans must not be allowed to remain in the water until entirely cold, but must be taken out after the temperature has fallen to about 120 to 140 degrees.



This amount of heat will not injure the goods and will be sufficient to thoroughly dry the cans, thus freeing them from water that would be likely to cause more or less rust. If it is desirable or necessary, as in the case of corn processed at 250 degrees, to cool off in the retort, introduce a water pipe at about the level of the upper blowoff in side of kettle, arranging a "spreader" to be put in place after crates are placed in retort. All goods will darken or scorch when processed at 250 degrees if removed from the retort and exposed to a direct current of air—particularly so in the case of corn, which must be cooled in the retort. When crates are removed from the cooling bath, allow time enough for every vestige of moisture to dry off before stacking the still warm cans in warehouse.

#### DUTIES OF SUPERINTENDENT-PROCESSOR.

The duties of the Superintendent-Processor in a plant of the kind now under discussion are clearly defined by the above. As assistants he should have on his permanent staff:—

- One Receiving Clerk.
- One Kettle Man, or assistant processor.
- One Enigneer-Machinist.
- One Foreman.
- One Forewoman.
- One Inspector.
- One Seaming Machine Man.
- One Syrup and Brine Maker.
- One Sauce and Catsup Maker.

#### DUTIES OF OFFICE AND FACTORY HEADS.

*The duties of the Receiving Clerk* are to receive and keep a correct record of the raw materials, supplies, etc., noting that the condition of raw materials complies with the contracts or buyer's agreement; to keep a record of the quantity and cost of all raw material issued to the peeling-room, a daily report of which must be made to the office to be used as a basis in estimating the daily cost of goods packed.

*The Processor*, to be in charge of the process-room, cooking and cooling, on time given by the Superintendent. He also keeps the temporary and permanent process records.

*The Engineer-Mechanic*, to run engine, dynamo and pump, attend to pipe-fitting and repair work and such general duties as naturally belong to this department.

*The Foreman*, to have charge of all outside work and floating male labor.

*The Forewoman*, in general charge of all female labor.

*The Inspector*, to examine prepared raw material and issue checks therefor to pieceworkers. The Inspector should be charged

with checks given her and credited with all given out and returned by her daily, the office keeping a record of the checks issued for each variety handled for use in computing cost of finished goods.

*The Seaming Machine Man* should be in charge of all work on the seaming or closing machines. A record of all work passing through this room should be kept, including size of cans and variety and grade of goods.

*The Syrup and Brine Maker*, to keep up the supply of these articles as the pack may demand, and record amounts of sugar, salt, etc., used daily.

*The Sauce and Catsup Maker*, also to be in charge of handling the tomato pulp.

It is, of course, understood that these helpers are not to confine themselves to the duties here outlined, but when not actively employed at their own proper tasks are to render assistance wherever their aid may be required.

### PROCESSOR'S RECORD.

Processors should keep a temporary daily record of each kettle and batch on a slate or blackboard, with both "in" and "out" time, and transfer this temporary record each night to a permanent record written with ink. To avoid errors, frequently check the figured process times.

When several varieties or grades are being processed at the same time, attach metal markers plainly designating the contents, to each crate.

### LACQUERING.

At this period, while the cans are still warm, is a good time for lacquering tops and bottoms. While the cans are still in the crate the tops should be lacquered; then pile on floor in even rows, lacquered end down, and apply a coat of lacquer to the bottoms. Proceed in this manner until the day's output is piled up, and in such regular rows that each day's output may be correctly counted, which is a necessary feature in calculating the cost of packed goods. The cans must be perfectly dry before applying lacquer.

There are one or two very good lacquering machines now on the market. These machines handle the cans so well and so rapidly that they are an economical necessity. If present indications are borne out, the day is not far distant when all canned foods will be lacquered before leaving the factory. In the past lacquered cans have been under a ban, owing to unscrupulous parties taking old and damaged goods and lacquering them to conceal their real condition. The previous lacquering of all goods will prevent this imposition, keep such unscrupulous parties from hurting the entire canned food market, and reduce the amount of loss from swells and leaks due to rust. Cans containing such articles as baked beans, soups, pud-



dings, etc., which are intended to be prepared for table use by heating in boiling water, should not be lacquered. The boiling water melts a portion of the lacquer, which adheres to the side of the kettle, and is, to the disgust of the housewife, exceedingly difficult to remove. For this class of goods plain cans wrapped, instead of labeled, are preferable.

### BOXING.

Cans are placed in the boxes or cases, two dozen to the case usually, with the exception of gallon cans, which are packed either six cans to the case or twelve. Some care should be exercised in this operation, as otherwise the labels will be marred or entirely torn from the cans.

Four nails in each end of the lid will hold it securely. When side-nailing cases, if this is considered necessary, drive nails where they will come between the rows of cans. Cases for export must be strapped with iron and double-nailed.

### CONTRACTS.

For both tomato and corn packing it is necessary to be assured of a certain acreage of these products which will be sufficient, in normal seasons, to run the factory to its full capacity, and accordingly, even before the factory is an established fact, it is usual to make contracts with the growers for the acreage estimated to be required. The following typical forms for contracts may be used or so modified as to meet the conditions of your locality:

#### TOMATO GROWERS' CONTRACT.

(Make Out in Duplicate.)

No..... SMITHTOWN,.....19....

I, John Doe, hereby agrees to devote the land and furnish everything necessary to plant and cultivate in proper manner..... acres of land in tomatoes, all to be planted with the variety of seeds furnished by The.....Canning Company, to be well set with plants as early in the season as weather conditions will permit and to keep them well tended and cultivated, and I agree to deliver all the products of the above specified acreage to The.....Canning Company at their factory in Smithtown....., in a sound and ripe condition during the season of 19.... Tomatoes that are green on one side or not fully developed in size or color, or less than 2 inches in diameter, or bruised or jammed or overripe, will not be considered merchantable, and if not merchantable are subject to dock or refusal. I also agree, should I sell to any party or parties any tomatoes from this acreage without the written permission of The.....Canning Company, to forfeit to the said.....

Canning Company the entire sum received from such sale or sales.

Tomatoes when ripe to be delivered to the factory in slat boxes or splint baskets. I furthermore agree that, should I fail, for any cause within my control to cultivate the number of acres specified, I will forfeit \$.....per acre for such shortage.

The.....Canning Company agreeing that if they fail to receive all tomatoes above described when delivered during the days and hours named below, as fast as they can reasonably weigh and take care of them, they will pay me \$..... for each acre on account of each failure, except as hereinafter provided. All tomatoes delivered at factory are to be left in the crates or baskets until emptied in their regular turn.

In consideration of compliance with above conditions, The....  
.....Canning Company agrees to furnish all seed, free of charge, and to pay for the tomatoes \$..... per ton of 2,000 lbs. delivered in the condition above mentioned at its factory in Smithtown,.....  
Settlement to be made on.....

Tomatoes to be delivered between the hours of 6 A. M. and 5 P. M. on each working day of the week except Saturday; no tomatoes to be delivered on Saturday without permission.

I hereby agree that in case of the destruction of the cannery by fire or by the elements, or if for any unavoidable cause the factory is unable to receive all the tomatoes grown, said factory shall have the right to limit the delivery of said acreage.

.....Grower.

Witness Accepted,

..... THE.....CANNING Co.,

..... Per.....

CORN GROWERS' CONTRACT.

(Make Out in Duplicate.)

No..... SMITHTOWN,....., 19....

I, John Doe.....hereby agree to devote the land and furnish everything necessary, and to plant and cultivate in proper manner.....acres of sweet corn during season of 19... Said land to be farmed in a thorough manner, cultivated and hoed all that is necessary to produce a good crop. Said corn to be delivered to The.....Canning Company's canning factory, under their direction, and weighed on their scales. Corn shall be free from any small nubbins, cobs with no corn on, corn too young to be used, or too ripe, or too long stems or stalks. Corn to be sown





|                 |                |
|-----------------|----------------|
| Through.....    | Broker.        |
| .....Cases..... | @.....per Doz. |
| .....“.....     | @.....“        |
| .....“.....     | @.....“        |
| .....“.....     | @.....“        |

F. O. B. Cars at.....  
 Terms Sixty Days' acceptance or cash, less 1½ per cent., if paid within ten days from date of invoice. Guaranteed against swells for six months from date of invoice.

Shipments to be made.....

In case a partial failure of the crop we consent to the cutting down of this order twenty per cent. without liability for claim for damages and to accept a cash payment of fifteen cents per case for the cutting down of an additional twenty per cent. In case of the destruction of the cannery by the elements, the packer is not to be held liable for damages of non-delivery.

Remarks:

Accepted:

THE.....CANNING COMPANY,....  
 Per.....

Buyer.....

No contract valid until accepted and signed by the Company.

NOTICE!

Before equipping your factory; before buying any kind of a supply; before employing a broker and before buying farming or any other machinery, seeds, etc., used in connection with the canning business, consult the advertisements at the back of this book.

If not found there, write us; we will cheerfully furnish a list of reliable parties who will give you courteous treatment. Address THE JOURNAL OF THE CANNING INDUSTRY, Baltimore, Maryland.

FOREMAN OR SUPERINTENDENT CONTRACT.

The following form of contract may be used to advantage:

.....19

It is hereby agreed between John Doe, of Doeville, .....  
 and The.....Canning Company of Smithtown,  
 ....., that the said John Doe is hereby engaged as Superin-  
 tendent-Processor of their factory at Smithtown, .....for the  
 season commencing.....19 and ending.....19

The said.....John Doe.....to have entire charge of the  
 working of the factory, full command of all raw material from time  
 received until packed and delivered to warehouse and absolute con-



trol of the employees necessary to perform this work. The said John Doe agrees to use his best knowledge, skill and endeavor to make a successful pack, and further agrees that if, at the expiration of six months from date of packing, the loss by swells amounts to more than 5 per cent., to forfeit a percentage of his salary equal to the percentage of such loss greater than the allowed 5 per cent.

In consideration, The.....Canning Company agree to pay the said.....John Doe.....the sum of \$..... for this period in regular monthly installments of \$.....each; and the said.....Canning Company further agree that all official orders and requests shall be delivered to the said .....John Doe.....through.....or, in case of his disability, through some other person duly appointed.

Signed.....SS

Witness

.....SS

.....  
.....

In this connection, it may be well to say that ALL inexperienced parties engaged in the canning business should secure at the start a thoroughly experienced superintendent-processor to have sole and entire charge of the fitting up of the establishment and directing the pack at least for the first season. When there are several members of a concern, requests or orders concerning work or methods should be officially conveyed to the superintendent-processor by one member only.

Observance of this rule will frequently prevent much friction and unpleasantness not only between the superintendent and the concern, but also between the members themselves.



# VEGETABLES

The U. S. Food Standard is :

“Canned vegetables are sound, properly matured and prepared fresh vegetables, with or without salt, sterilized by heat, with or without previous cooking in vessels from which they take up no metallic substance, kept in suitable, clean, hermetically sealed containers, are sound and conform in name to the vegetables used in their preparation.”

## BLANCHING.

All green vegetables should be given a bath in running cold water for a sufficient length of time to make them plump and crisp. Blanching is simply the act of plunging the vegetables in a bath of hot water which may or may not contain salt. The bath is usually boiling when the article is dipped, and of such a capacity that the immersion will not more than momentarily check the boil. Blanching serves to set the color of green vegetables. The solvent power of pure water is sufficient to destroy the firmness, color and skin of many vegetables when cooked therein; this is why brine (the chemical action of salt is to harden water) is generally used to fill cans. And blanching likewise serves to produce the necessary softening in fruits and vegetables to insure good, close packing, to obtain the desired tenderness in some vegetables and to act as a cleansing agent.

## THE MAKING OF BRINES.

In preparing brine for canned vegetables there are but two elements to be regarded, as far as the materials that enter into the preparation of the brine are concerned. They are so familiar it is hardly necessary to mention them—water and salt. Yet many canners, by neglecting to give proper attention to the selection and preparation of these materials, have nullified the results of an otherwise careful process.

The water used in making brines should be soft; that is, not containing appreciable quantities of lime and free from iron. Whenever possible it should be obtained from wells and from springs, and if this is not possible filtration should be employed. In all cases careful tests should be made to determine the amount of impurities contained in the water, especial attention being given to the absence of iron and lime. Water which contains considerable quantities of



iron is apt to cause trouble from discolored liquor where a heavy process is employed, as in the case of beans, corn and peas. This discoloration is caused by the sulphite of hydrogen liberated in the processing uniting with the iron.

Not all instances of discoloration are due to the presence of iron in the brine, but the probabilities of discolored liquor and its consequences are so great where iron is present in the water that the greatest care should be taken to avoid such trouble. Iron is held in solution in the water by carbonic acid gas. This is a volatile gas, easily liberated by heat, precipitating the iron, which, being heavier than water, settles to the bottom of the brine. As a result brine drawn from the top of the tank may be free from iron, while that drawn from the bottom may cause serious trouble.

The presence of lime in the water used to make brines must be considered as equally deserving the attention of every painstaking canner. Nearly every packer knows the difficulty of obtaining the requisite tenderness in cooking vegetables which have shells such as corn, peas and beans when hard water is used. There is little question but that the presence of lime in the water used is responsible for this condition. Where the lime is present in small quantities no trouble is observed, but when present in considerable quantities it is precipitated in the cooking on the shells of the vegetables, forming the tough, insoluble covering canners are so anxious to avoid.

Recent tests by the Research Laboratories of the National Canners' Association show conclusively that hard water directly affects peas, beans etc., toughening them.

Water from different localities differs in degrees of hardness according to the locality and conditions governing. Water that may be perfectly satisfactory for washing and bleaching purposes will not do for process work unless treated. Where the lime is present as bicarbonates most of it can be driven off by heating and permitting it to stand, the lime precipitating with the heat and settling to the bottom of the tank, whence it is easily drawn off. This can be accomplished by heating with live steam or by means of a coil of steam pipes. This method of heating will also free the water from the presence of iron in the same way as it does the lime, by precipitation.

In ordinary cases some such method of treatment will be sufficient to reduce the lime and iron in the water below the danger mark and avoid the sources of trouble in the brine as far as the water is concerned. A greater degree of hardness must be treated by special methods.

The purity of the salt used in making brines is of equal importance. It is of little use to purify and filter the water used and then put right back into the brine through impure salt an equal or greater amount of foreign matter than has been removed in treating the water.

The principal impurities found in ordinary salt are the sulphates and chlorides of calcium and magnesium; sulphate of lime or gypsum is present in larger quantities. Where this impurity amounts to more than 2 per cent. the use of such salt should be avoided by all means, as the presence of lime in such quantities almost precludes the possibility of cooking the vegetables to the requisite tenderness.

While a salt which is over 98 per cent. sodium chloride cannot in itself be classed as unfit for canners' use, the presence of lime in the water used to make the brine, added to that contained in the salt, may result seriously in the finished product. Every canner should submit to a reputable chemist a sample of the salt he intends using in his season's pack, absolutely rejecting any brand that falls below 98 per cent. pure salt. To be safe rather than sorry a packer should not use a salt which tests under 99 per cent. Such a salt cannot contain excessive amounts of lime.

There is no reason why any packer should take chances with ordinary salt. There are a number of brands of salt on the market which conform to the canners' requirements, and will give him ample returns in the way of satisfactory output. It pays always to use the best.

For the reasons above given it seems as though the preparation of a pure brine must be considered one of the most important steps in the canning business. The danger of a discolored liquor, toughened shells and unsatisfactory flavor resulting from the presence of iron and lime in the brine either from the salt or the water can be avoided. A little care will secure pure water, and the same attention given the salt question will reap satisfactory rewards in improved product.

### MAKING BRINE.

For making brine jacketed copper kettles, wooden tanks with closed copper coils in bottom, or wooden tanks with steam jet, may be used. If a steam jet is employed, carry a copper pipe with an L on end to bottom of tank and direct to opposite side. In making brine, first bring the water to a violent boil, then add the sugar, salt, etc., and stir until dissolved. If the steam jet is used, little or no stirring is required. Guard the bottom outlet of tank with a strainer to retain chips and particles of paper which may be in the sugar and salt. If the material used contains much dirt or specks place it in a closely-woven bag and suspend just below the surface of the boiling water.

By dissolving the amount of salt specified in the first column of the following table in  $12\frac{1}{2}$  gals. water, the percentage of salt contained in the resulting solution will approximate:



|                         |                 |                   |         |
|-------------------------|-----------------|-------------------|---------|
| 1 oz.....               | 1-16th          | of 1 per cent. or | .000625 |
| 2 oz.....               | $\frac{1}{8}$   | of 1 per cent. or | .00125  |
| 4 oz.....               | $\frac{1}{4}$   | of 1 per cent. or | .0025   |
| 8 oz.....               | $\frac{1}{2}$   | of 1 per cent. or | .005    |
| 1 lb.....               | 1               | per cent. or      | .01     |
| 2 $\frac{1}{2}$ lb..... | 1 $\frac{1}{2}$ | per cent. or      | .015    |
| 2 lb.....               | 2               | per cent. or      | .02     |
| 3 lb.....               | 3               | per cent. or      | .03     |

### ASPARAGUS, NO. 1 PROCESS.

Wash free from adhering earth and give bath in cold water until crisp. Scrape off the tough outer skin and roughly assort according to diameter of stalks. Cut off butt, leaving top of right length for can. Wash thoroughly in cold water; place carefully, butts down, in a wire basket provided with a cover to keep stalks in place. Have ready a boiling hot bath, plain or containing  $\frac{1}{2}$  lb. salt to 12 $\frac{1}{2}$  gals. water; immerse the grass for from two to five minutes, or until the stalks are flexible and will not snap on handling.

Then drop in cold water for the longest convenient period; place carefully in cans and fill with cold brine (2 $\frac{1}{2}$  lbs. salt to 12 $\frac{1}{2}$  gals. water), seal and exhaust:

No. 2 cans, 8 minutes; No. 3 cans, 10 minutes, and 4-lb cans, 12 minutes. Process at 240 degrees No. 2 cans, 10 minutes; No. 3 cans, 12 minutes; 4-lb. cans, 15 minutes; and at 212 degrees, No. 2 cans, 40 minutes; No. 3 cans, 45 minutes, and 4-lb. cans, 50 minutes.

Remove from process kettle and drop in cooling bath. For glass jars, fill with cold brine and allow same process without exhausting.

### ASPARAGUS TIPS, WHITE.

Cut tips from stalk, place in cold water to crisp, blanch two minutes in bath containing salt  $\frac{1}{2}$  lb., water 12 $\frac{1}{2}$  gals. Drop in cold water for the longest convenient period; fill in cans, with brine (2 $\frac{1}{2}$  lbs. salt to 12 $\frac{1}{2}$  gals. water).

Process at 240 degrees, No. 1 cans, 8 minutes; No. 2 cans, 10 minutes; No. 3 cans, 12 minutes; 212 degrees, 1-lb. cans, 35 minutes; 2-lb. cans, 40 minutes; 3-lb. cans, 45 minutes.

Drop in cooling bath.

### ASPARAGUS TIPS, GREEN.

Cut tips from stalk, place in cold water to crisp, blanch two bath containing  $\frac{1}{2}$  lb. salt to 12 $\frac{1}{2}$  gals. water. Place in cans, add hot brine, and process same as white tips.

## ASPARAGUS PULP FOR SOUP.

After washing the stalks left in preparing white tips, place in a jacketed kettle, cover with cold water, bring to a boil and cook twenty minutes; then add  $\frac{1}{2}$  lb. salt for each  $12\frac{1}{2}$  gals. contained in kettle and cook ten minutes longer, drain off water, reserving a small portion, and run the grass through a rotary pulper. To the resulting pulp add enough of the reserved water in which it was cooked to make it handle easily; while still hot fill into No. 10 cans, and process 20 minutes at 240 degrees or 40 minutes at 212 degrees.

## DRY BEANS—VARIETIES.

A knowledge of the many varieties of beans is a subject for the trained specialist.

“NAVY BEANS” OR WHITE BEANS (small or medium).

The term “navy bean” is used here in the broader sense, implying any of the types of small or medium white beans used in the preparation of “baked beans.” “Navy bean” is also used in the trade as synonymous with “pea bean.” In view of the ambiguity in the use of the term, it is suggested that “white bean” or “pea bean” be used to avoid misunderstanding.

| NAME                                        | SIZE                       | SHAPE                           | COLOR                 | SOURCE                                                |
|---------------------------------------------|----------------------------|---------------------------------|-----------------------|-------------------------------------------------------|
| 1. Pea or Navy                              | Small                      | Oval, round                     | Pure white            | California<br>New York<br>Michigan                    |
| 2. Medium                                   | Somewhat larger than No. 1 | More oval than No. 1            | Pure white            | Michigan<br>New York<br>California<br>Idaho<br>Oregon |
| 3. California Small White                   | Smaller than No. 1         | Not so broad as No. 1           | Pure white            | California<br>Idaho                                   |
| 4. California Large White (Lady Washington) |                            | Longer and more oval than No. 1 | Pure white            | California<br>Idaho                                   |
| 5. Kotenashi                                | Similar to No. 3           | Similar to No. 3                | White                 | From Orient (Manchuria)                               |
| 6. Tepary*                                  | Smaller than No. 1         |                                 | White, greenish tinge | California<br>Arizona                                 |

\*Not recommended for Army use (see later under “undesirable varieties.”)



LARGER AND COLORED VARIETIES.

The following table is not intended to be exhaustive, but merely represents some of the commoner varieties :

| NAME          | SHAPE                                | COLOR                             | SOURCE                    |
|---------------|--------------------------------------|-----------------------------------|---------------------------|
| 1. Red Kidney | Kidney-shape; elongated; oval; plump | Red                               |                           |
| 2. Kintoki    | Almost Globular                      | Very dark red                     | Japan                     |
| 3. Pinto.     | Short; kidney-shape                  | Buff speckled with brown          | Colorado<br>New Mexico    |
| 4. Lima       | Flat; kidney-shape                   | Greenish white                    | California                |
| 5. Marrow     | Round; oval; symmetrical             | Red; also white                   | Northern United and Japan |
| 6. Soy*       | Almost Globular                      | Dull yellow (also dark varieties) | States<br>Southern States |

\*A small bean. Not recommended for Army use (see later under "undesirable varieties.")

QUALITIES.

Good beans are plump and firm under pressure. They should not be dented when pressed with the thump-nail. Beans soft enough to dent have too much moisture. Beans for the Army should be dry; that is, not contain more than 20 per cent. of moisture. White varieties should be uniformly white.

SPECIFICATIONS.

*Michigan and New York White Beans.*—These should comply with the following specifications and grades of the Michigan Bean Growers' Association:

*Pea Beans* should be of good average color of the crop-year, sound, dry, well screened, and be within the following limits:

| Grade.                  | Discolored and Split Beans. | Medium or Large Beans. |
|-------------------------|-----------------------------|------------------------|
| Choice Hand Picked..... | 1.5 per cent.               | 7 per cent.            |
| Prime Hand Picked.....  | 3.0 "                       | 10 "                   |
| Fancy Screened.....     | 3.3* "                      | 10 "                   |
| Choice Screened.....    | 5.0* "                      | 10 "                   |

\*Including foreign substances.

Sometimes these percentages are expressed as pounds per bushel, one bushels of beans weighing 60 pounds. There is another grade called *one pound pick pea beans*, which should be of good average color of the crop-year, well screened and not contain more than one pound of discolored or split beans or foreign substances.

*Medium Beans* conform to the same specifications except that the column "medium or large beans" is omitted.

*Michigan and New York Beans are Purchased on a Choice Hand Picked Basis.* When it is not possible to obtain these, *Prime Hand Picked* grade may be purchased.

*Western White Beans.*—These are purchased under grades which are determined each year by the California Bean Jobbers' Association in San Francisco.

The grade purchased for the Army is *Choice Recleaned*. This grade calls for beans that are bright, of average color of the year's crop, well screened and equal to, or better than, the season's average quality of grade bought for the current season at time of shipment. Current types are established for each season's delivery.

*Japanese Beans.*—These should all be hand-picked and correspond in quality to the Choice Hand Picked Michigan grading.

*Red Kidney Beans.*—Michigan gradings are:

*Choice Hand Picked* must be light red in color, bright, sound, dry, well screened and not contain more than 1½ per cent. of discolored and split beans, nor more than 3 per cent. of sports or blue beans. *This is the grade that should be purchased.*

*Prime Hand Picked* have the same qualities as C. H. P., except that they may be fairly bright and contain not more than 4 per cent. of discolored and split beans, nor more than 4 per cent. of sports or blue beans.

*Pinto Beans.*—These should be *Choice Recleaned* according to the following specifications of the Rocky Mountain Bean Jobbers' Association:

*Choice Recleaned*, after threshing through a bean-cleaning machine, should be a uniform run of bright, sound, dry, medium to large Pinto Beans. They may contain in weight not over ½ per cent. of dirt, adobe, small stones or foreign matter; not over 1½ per cent. of split beans; and not over 6 per cent. of weather damaged, shrunken, frostbitten or discolored beans. The last four types of beans shall include only such beans as, when split, show meat discolored or darker than the meat of the rest of the healthy beans in the sample.

*Number Two* shall be the same as *Choice Recleaned*, except that they may be fairly bright and not exceed the following limits: 1½ per cent. of dirt, etc.; 3 per cent. of split beans; 8 per cent. of weather-damaged beans, etc.

#### UNDESIRABLE VARIETIES.

The following beans, as a rule, should be avoided:

*Tepary Beans* usually have a very hard skin and require long soaking. Although some lots are satisfactory, the quality is unreliable.

*Soy Beans* have a high oil-content and are quite different in properties from other beans. They have not as yet been recommended for general use.

#### PROCESSED BEANS.

(Formerly known as "Baked.")

Beans are classed among the winter packed goods, and their handling is not easy. Like many other articles, they turn out very poor unless they are well packed. It might truly be said there is no room for a poor quality of baked beans. Unless the packer makes up his mind to put up a standard or better grade of beans he had better not touch them, for he is almost certain to lose money. There are goods in the canner's line that it pays to pack as seconds, because



there is a certain demand which cannot be supplied by standards because of the prices, but not so with baked beans. The old condition of cheap dried beans and their preparation in every kitchen holds, and seconds or worse than seconds, in the generally accepted terms and understanding of seconds, will not overcome the condition.

Good beans will average about 75 No. 3 cans per bushel.

#### HIGH-GRADE SAUCE.

2 gal. Whole Tomato Pulp (Sp. gr. 1.035).  
 1 $\frac{3}{4}$  lbs. Sugar.  
 3 ozs. Onions.  
 1/10 oz. Bay Leaves  
 2/10 oz. Paprika.  
 2  $\frac{4}{10}$  ozs. Butter.  
 10 ozs. Salt.  
 $\frac{1}{2}$  oz. Red Pepper.  
 Water to make 5 gallons.

#### PLAIN SAUCE.

25 gal. Water.  
 1 gal. Salt.  
 $\frac{1}{2}$  gal. Dist. Vinegar.  
 2 gills Dry Mustard.  
 4 lbs. Flour.  
 1 $\frac{1}{2}$  gal. Molasses.  
 1 gal. Catsup.

#### TOMATO SAUCE.

25 gal. Water.  
 $\frac{3}{4}$  gal. Vinegar.  
 1 $\frac{1}{2}$  gal. Dark Molasses.  
 $\frac{3}{4}$  gal. Salt.  
 3 gills Dry Mustard.  
 5 gal. Whole Tomato Pulp.  
 3 lbs. Flour.

In both cases use spices in bag suspended in jacketed kettle while sauce is boiling—2 ozs. each cloves, stick cinnamon and all-spice.

*Amount of Pork Per Can.*—The average amount of pork to be placed in the different sized cans is:

In a No. 1 can, one-third of an ounce.

In a No. 2 can, two-thirds of an ounce.

In a No. 3 can, one ounce.

*Tomato Sauce.*—The tomato sauce added to beans canned for Army use should be made of tomato pulp, with the addition of sugar, salt, spices and, if necessary, enough water to give it proper fluidity. These ingredients should

be mixed in such proportions as will give a high-grade article of proper flavor and consistency.

The pulp used should be prepared from whole, clean, sound, ripe tomatoes, no portions of which should be decayed; without the addition of skin or core pulp, and without the addition of starch or other thickening agent.

The pulp must comply with the requirements of the United States Department of Agriculture as to number of bacteria, yeasts and molds.

*Plain Sauce.*—When beans are canned for Army use with plain sauce, this sauce should consist of such ingredients as spices, salt, sugar and molasses, mixed with just enough water to give it proper consistency, but not enough to form a free liquid.

*Grades of Canned Beans.*—*Fancy.* The *Fancy* grade is made from Choice Hand-Picked stock.

*Extra-Standard.* The *Extra-Standard* grade is made from Prime or second-grade stock.

*Standard.* The *Standard* grade is made from Farmers' or Field-Run stock.

*Size and Net Weight of Cans.*—Canned beans may be packed in No. 1, No. 2 and No. 3 cans. The following minimum net weights are required:

| Number. | Size of Can. |            | Net Weight.                                 |
|---------|--------------|------------|---------------------------------------------|
|         | Diameter.    | Height.    |                                             |
| No. 1   | 2 11/16 in.  | 4 in.      | Not less than 11½ oz.                       |
| No. 2   | 2 7/16 in.   | 4 9/16 in. | Not less than 1 lb., 5 oz. (equals 21 oz.)  |
| No. 3   | 4¼ in.       | 4 7/8 in.  | Not less than 2 lbs., 3 oz. (equals 35 oz.) |

## BEANS WITH PORK.

Select and clean pea beans of recent growth, place two bushels in a 50-gal. bbl. and nearly fill with a solution of 2 lbs. salt in 12½ gals. water; soak 12 hours, then drain off surplus liquid.

Old beans will require a soak of 18 to 24 hours, and usually an increase in process time.

If the cost of the finished product will allow, place one bushel of beans in a 50-gal. bbl., nearly fill with brine and soak 4 to 8 hours, then drain off and replace with fresh brine and soak 4 to 8 hours; draw off this brine and cover beans with fresh water, soak 4 hours and drain. This removes much of the rank flavor and improves the finished goods. Slice salt pork (bellies) thinly and place in bottom of cans; ¼ oz. in No. 1 cans, ⅜ oz. in No. 2 cans, ½ oz. in No. 3 cans; then fill cans ⅞ full of the soaked beans and add sauce:

2½ lbs. Salt.  
 3 lbs. Sugar.  
 ½ lb. Ground White Pepper.  
 ½ Pint Caramel (burnt sugar coloring).  
 12½ gals. Water.

Process at 240 degrees, No. 1 cans 2 hours; No. 2 cans 2½ hours; No. 3 cans 3 hours. With open bath (212 degrees), allow double the time.

A little corn starch added to the sauce will give it more body and cause it to adhere to the beans, but the Government considers this addition of corn starch illegal.



## BEANS WITH PORK AND TOMATO SAUCE.

Soak the beans as before directed; after draining off the surplus liquid, add to each 100 gals. of the soaked beans 10 gals. of the following sauce:

- 30 gals. Tomato Pulp.
- 10 gals. Water.
- 20 lbs. Sugar.
- 6 lbs. Salt.
- 10 oz. Ground Yellow Mustard.
- 12 oz. Ground White Pepper.
- 6 lbs. Brown Sugar or 1 gallon Molasses.
- 2 ozs. Ground Saigon Cinnamon.

Any grade of tomato pulp as prepared for making catsup may be used, but canned stock made by boiling down entire tomatoes is preferable.

Place the pulp and water in kettle, bring to a boil and dissolve the sugar and salt, then add the other ingredients and mix.

After placing the pork in cans, fill seven-eighths full of the mixed beans and sauce. Handle and process as above.

## BEANS WITH PORK AND TOMATO SAUCE, FANCY GRADE.

Soak the beans in salted and freshen with several changes of pure water. Substitute concentrated tomato juice for the tomato pulp and water in the sauce. Handle and process as above.

BAKED BEANS WITH PORK AND TOMATO SAUCE.  
EXTRA FANCY GRADE.

Soak and freshen the beans, drain off water, place in jacketed kettle and cover with cold water; bring to a boil, then reduce to a gentle simmer and cook until the skin will crack by blowing on them when held in the hand. Drain off the water, reserving a portion of it for use; place the beans in iron pots of 2 gals. capacity and provided with tightly fitting covers; add one pound of butter and enough of the water in which the beans were cooked to just cover the beans; place cover on pot and bake 2 hours in a suitable oven. Remove beans from the pots and mix with a fair proportion of the following sauce:

- 10 gals. Canned Pulp from whole Tomatoes.
- 10 gals. Concentrated Tomato Juice.
- 15 lbs. Sugar.
- 4 lbs. Salt.
- 8 oz. Ground White Pepper.
- 1 oz. Ground Saigon Cinnamon.

In the meantime prepare the pork by covering with cold water in a kettle, bring to a boil and cook slowly 2 hours. Strain and clarify the grease which separates in cooking the pork. It may be used in enriching bean soup or the poorer grades of baked beans. Cut pork in suitable slices, place in cans and fill nearly full with the prepared beans.

Process at 240 degrees, No. 1 cans, 30 minutes; No. 2 cans, 45 minutes; No. 3 cans, 60 minutes; at 212 degrees, No. 1 cans, 60 minutes; No. 2 cans, 90 minutes; No. 3 cans, 120 minutes.

### BAKED BEANS IN INDIVIDUAL POTS.

Soak the beans as directed for plain pork and beans; drain off the salt water, and cover with cold water; add the desired amount of salt pork cut in chunks of one pound or less; bring to a boil, then simmer until beans are thoroughly cooked and soft; remove the pork and cut in small, thin slices; drain the water from the beans, reserving a portion, which thicken with beans from which the skin has been removed by rubbing through a sieve; to each gallon of this thickened water add 1 lb. of salt, 2 oz. ground white pepper. Mix sufficient of this sauce with the cooked beans to make a mass of the desired consistency; fill the pots half full, then add a slice of pork, and finish filling the pots with beans. Moisten the surface slightly with a solution of 1 lb. of sugar in 2 pints of water; then brown top by passing through a gas oven arranged with overhead burners.

The above formula is used only for restaurant service or immediate uses.

### LIMA BEANS.

There are several methods of packing beans; one in their fresh or natural state, another in the dried, or what is known as "soaked" or "winter packed," and a third way in connection with corn, this last being known as "succotash." We will first treat the Lima bean in its natural or green state, in which it makes the most presentable article, the one which brings the best price in the market.

These goods are in general demand, and are mainly packed in No. 2 cans. They are not particular in any section, though California and Michigan may lay claim to being the greatest bean-producing States in the Union. There is no doubt that they do turn out the bulk of dried beans, supplying almost the entire market.

But Lima beans suitable for canning are grown in every section of the country, though special arrangements will have to be made by canners with the growers, as the usual limited amounts grown on the farms cannot be depended on for a pack of any size.

A good Standard would read: "Cans full of green beans, clear liquor."



Shell and clean the beans; separate into two sizes with rotary sieves; spread out on table and pick out yellow and imperfect beans; crisp in cold water; blanch in boiling water two minutes; place in cans; fill with hot  $2\frac{1}{2}$  per cent. brine.

Process: Small Beans, No. 1 Cans, 30 minutes at 240 degrees.

Small Beans, No. 2 Cans, 35 minutes at 240 degrees.

Large Beans, No. 2 Cans, 40 minutes at 240 degrees.

### LIMA BEANS, YELLOW (DRIED).

Shell and clean the beans; blanch 5 minutes in a 1 per cent. solution of salt water; pick out imperfect beans, fill into cans and fill with the following syrup:

|                              |  |                                  |
|------------------------------|--|----------------------------------|
| $2\frac{1}{2}$ lbs. Salt.    |  | Process No. 2 Cans 45 minutes at |
| $12\frac{1}{2}$ gals. Water. |  | 240 degrees.                     |

If preferred in their liquid, use same brine as for green Limas.

### RED KIDNEY BEANS.

Soak the beans in cold water 12 hours, drain off water, place on sorting table, and pick out all split beans and those with ruptured skins; fill cans about seven-eighths full and fill with boiling hot syrup made as follows:

$12\frac{1}{2}$  gals. Cold Water.

3 lbs. Salt.

4 lbs. Bean Flour, or Ground Beans.

Place the salt and 10 gals. water in kettle and bring to a boil; mix the remainder of the water with the bean flour; add to the boiling salt solution, stirring vigorously, and bring to a full boil.

Process: No. 2 cans,  $2\frac{1}{2}$  hours at 212 degrees, or 75 minutes at 240 degrees; No. 3 cans, 3 hours at 212 degrees, or 90 minutes at 240 degrees.

### STRING BEANS.

More smaller the beans are, the finer the article they will make, because they are more tender and nearly free from the tough string, from which they take their name, and which forms as the bean grows. The beans are also then of a fine color, being the rich dark green so desirable. The finest beans are picked when only about  $\frac{1}{8}$  of an inch thick; and for this reason, of course, a large quantity is required. From this size up they will grade according to the time picked.

After being picked, they should be brought to the factory with as little delay as possible, and care should be given that they are placed in splint baskets or slatted crates, never in bags. The reason for this, as is well known, is that when packed in bags they sweat and become tough, losing their crisp, brittle nature. If the beans

become wilted, they should be placed in fresh, cold water, allowing them to stand for a time, which largely restores their crispness.

Wash them in cold water to remove all grit, and string carefully from both ends; then break or cut into pieces one inch or  $1\frac{1}{2}$  inches long. The smallest sizes are packed whole.

In the last few years there have been put on the market a number of very useful machines for grading the beans into the various sizes, for cutting them to any desired length and for filling them into the cans.

The Standard of the Canned Goods Exchange calls for: "Cans full; beans young and tender and carefully strung, packed during the growing season."

After properly preparing them, blanch two minutes, or until tender, in boiling water; place in cans, fill with  $1\frac{1}{2}$  per cent. brine, and process for the usual, average size beans:

No. 2 cans, 40 minutes at 240 degrees, or 60 minutes at 212 degrees. No. 10 cans, 2 hours at 212 degrees. There is a distinct advantage in using the lower temperature, as the color and flavor are better. The smaller sizes require less time, dependent upon their tenderness.

#### GREEN STRING BEANS, FANCY GRADE.

Select very small, young and tender beans, as stated above. Wash and crisp thoroughly in cold water; string very carefully from both ends, using the thumb nail instead of a knife to start; place carefully in cans without breaking; fill with hot  $1\frac{1}{2}$  per cent. brine. Process: No. 2 cans, 30 minutes at 240 degrees, or 45 minutes at 212 degrees.

#### WAX BEANS.

These are handled and processed the same as green string beans. Care, however, must be taken to remove all the specked or discolored beans.

#### BEETS.

The inside enameled sanitary can has proven very efficient in holding the color of beets, and other red fruits and vegetables, indefinitely.

Use only such varieties of beets as have a very strong, deep red color and with narrow, fibrous rings which do not become prominent after cooking. So much of success depends upon appearance that only the best varieties should be considered.

The beets should be washed, graded for size, and then placed in boxes or cages and steamed in the retort under pressure—about 225 degrees fahrenheit—for a sufficient time to loosen the skin, from 5 to 15 minutes, depending upon the size and the length of time out of the ground.



Allow the leaf stems to remain during the preliminary cooking, as it prevents the bleeding and loss of much of the natural beet color; they also serve as a handle while trimming and skinning.

*Extra Grade.*—Select small garden beets, the largest not more than  $1\frac{3}{4}$  inches in diameter, wash thoroughly to remove all adhering soil, cut top off at base of leaf, place in wire baskets and steam at 214 degrees for 12 minutes, or boil in water for 15 minutes; drop in cold water, then shave off rootlets; skin and cut off tops close; place in cans, hot dip in syrup (sugar 2 lbs., salt  $2\frac{1}{2}$  lbs., water  $12\frac{1}{2}$  gals.). Process No. 3 cans, 50 minutes at 212 degrees.

*Standards.*—Handle large beets in the same manner, but allow more time for the preliminary cooking. The beets should be about three-quarters done before trimming and skinning. If there is a great variation in the size, sort roughly before cooking. After cooking, halve or quarter, if necessary, pack in cans with hot brine (salt  $2\frac{1}{2}$  lbs., water  $12\frac{1}{2}$  gals.). Process same time as small ones.

### BRUSSELS SPROUTS.

Pick off all dead leaves, wash well in cold water, blanch 3 minutes in boiling hot bath containing salt  $1\frac{1}{2}$  lbs., Bicarb, Soda  $\frac{1}{4}$  lb., water  $12\frac{1}{2}$  gals.; place in cans, with hot brine (salt  $1\frac{1}{2}$  lbs., water  $12\frac{1}{2}$  gals.), and process No. 2 cans 35 minutes at 212 degrees; No. 3 cans 45 minutes at 212 degrees.

### BOILED CABBAGE.

Clean off all outside green leaves, cut in quarters and remove all core, and if the cabbage is very large and coarse, the large midribs. Wash thoroughly in cold water, keeping a sharp lookout for worms. Blanch the cleaned cabbage in boiling water until it is thoroughly wilted, say 10 to 15 minutes, or place in cages in a retort and give 5 minutes at 240 degrees. Pack tightly in cans soon as cool enough to handle, fill with hot 3 per cent. brine and process.

No. 3 cans, 45 minutes at 240 degrees; No. 10 cans, 90 minutes at 240 degrees.

### CAULIFLOWER.

Pick off outer leaves and cut stalk close to head, break apart and crisp in cold water; blanch 3 minutes in bath containing salt  $1\frac{1}{2}$  lbs., water  $12\frac{1}{2}$  gals., place in cans, fill with hot brine (salt  $1\frac{1}{2}$  lbs., water  $12\frac{1}{4}$  gals.), and process No. 2 cans 12 minutes at 240 degrees, 35 minutes at 212 degrees; No. 3 cans, 15 minutes at 240 degrees, 45 minutes at 212 degrees.

### CELERY.

Cut cleaned celery also the green and unsightly portions of that left in preparing celery for salads, in pieces  $\frac{3}{4}$  to 1 inch long,

crisp in cold water, place in cans and hot dip in brine (salt 1 lb., water 12½ gals.), seal, and process at 240 degrees, No. 2 cans 12 minutes, No. 3 cans 15 minutes; at 212 degrees, No. 2 cans 35 minutes No. 3 cans 45 minutes.

### CELERY FOR SALADS, ETC.

Select fine white celery, cut off roots, all green portions and leaves, crisp in cold water; cut in pieces  $\frac{1}{4}$  to  $\frac{3}{8}$  of an inch long, place in glass jars and fill with hot syrup (1 gal. 60-grain vinegar, 2 gals. water); close jars and sterilize pints one hour at 190 degrees.

### CELERY PULP FOR SOUP.

Wash white celery thoroughly, cut in pieces, and place with the trimmed roots in jacketed kettle, cover with cold water, bring to a boil, and cook 30 minutes or until tender; drain off the water, reserving a portion of it. Pass the celery through a rotary pulper, mix the resulting pulp with enough of the reserved water to make it handle easily; place while hot in No. 10 cans, seal, and process 30 minutes at 240 degrees.

### CORN.

While the packing of corn occupies the second place of importance in the list of canned articles, it is difficult, owing to the greatly varying conditions existing in the different sections, and the variety of machines and systems employed in its packing, to do more than give an outline of such process as may be generally adopted.

And let us here again remind the reader that none of the times of process given in this Course should be used on an entire pack of any article without first giving them a thorough testing on a small batch of the goods to be packed. The reason for this primary testing is that the conditions in any section of the country are liable to vary somewhat from other sections, and, in fact, are almost certain to do so, owing to the difference in altitude, a difference in the water, a difference in the soil or fertilizers used, and various other causes which directly affect the fruit or vegetable grown in that section. These differences are shown in the goods after being packed, and, to counteract them, the treatment must be slightly changed, as may be required. *It is absolutely impossible to set down one fixed time on any article for all sections and conditions, and this must be borne in mind.* We give in this Course the times that are in most general use, as the basis of action, to be changed slightly one way or the other as occasion demands. It is always understood that common sense and good judgment must be added to all working formula.



Under any and all conditions, corn requires careful handling to produce a fine article, and the season, whether it be wet or dry, the soil and the treatment of the growing crop will be found to have had an effect upon the green corn, which must be counted upon in the process-room. For corn there is always a good market, and a relatively poor market for a poor article.

The great corn-packing sections are Maine, New York, Maryland, Iowa, Illinois, Ohio, Michigan, Indiana, Minnesota and Wisconsin. With the exception of the Southern States and California, nearly every State in which the canning industry is conducted finds some corn packed.

To make a financial success of packing sugar corn, it is necessary that the canning factory should control a large enough acreage to warrant the installation of the latest and best machinery. This line of machinery has advanced probably further toward perfection than any single line of machinery connected with the canning industry, and is today practically automatic in its action. Hence, it goes without saying the production of a factory is immensely increased by its use, while, at the same time, the quality of the product is improved. This is the great consideration in this article, and, in fact, has resulted in almost the entire disappearance of the hand-packing corn cannery.

*Factory Arrangement.*—If corn alone is to be packed, the plant should be placed in a three-story building and so arranged that one machine will discharge directly into the following machine. In the factory the filling and closing line is necessarily placed on one floor.

There is a great variety of arrangements of the factory for packing corn, probably as many as there are corn-canning plants, but the idea to be kept in view in all cases is to have the corn come to the factory and pass through the entire treatment, until it comes out in the sealed can, with as little confusion as possible and no double handling. When the active packing season comes on, everything must be handled quickly, for the season is short and corn must not be allowed to stand. For this purpose everything must be in exact order before the season opens.

Simply summing up what has been said, to pack corn successfully, it is necessary to have a large acreage of sugar corn contracted for; the factory should be equipped with modern corn-canning machinery, and great care must be exercised in packing that a first-class article may be packed.

The growing corn should be closely watched and when at the desired stage of development should be pulled in the early morning, even when it is not desired to deliver to the factory until late in the day. When it can be possibly avoided, carry no corn over until the next day; if unavoidable, spread it out in such a way that air will have free access to it.

When received at the factory, husk the corn and separate the defective ears; trim and cut out worm-eaten places, and remove all black and discolored spots; run through brushing machine to remove as much silk as possible, then through washing machine; then through cutting machine; then through silker; then into the mixer, where add the desired amount of syrup or "brine"; then into the cooker, where the temperature should be raised to 175 degrees. When starting the filler after a shut-down, return the first few cans to the cooker. Corn must go into cans at a temperature as near 170 degrees as possible; if filled at a higher temperature, the cans will be slack when cold; if at a lower temperature, the process time must be increased. When work is once started, the operations should be continuous; it is especially necessary that it be kept constantly moving from the time it is placed in the cooker until it reaches the retort. After processing, cut cans frequently to detect darkening, slack or overfilled cans.

At the end of the day's work, clean all machines thoroughly, removing every particle of corn and gummy matter, using a liberal quantity of hot water in which "Wyandotte" has been dissolved.

In some sections corn appears to keep perfectly when processed at 240 degrees, but, as complications are constantly arising, which would have been prevented had a greater heat been used, it is advised that not less than 246 degrees be employed in any section. When processed at this temperature the corn will darken if cans are removed immediately after the process and exposed to the air; consequently, it must be partly cooled in the retort with water.

### GRADES.

The grading of Maryland style corn is similar to that of Maine style. The basis of the difference in quality is the actual condition of the corn grains.

*Fancy.*—Corn in Maine style should be young, tender, contain no tough grains, be medium moist, absolutely free from silk, bits of cob or husk, and be only slightly darker than the natural product. It should have a flavor characteristic of young corn.

The kernels of corn in Maryland style should be young, tender, of good flavor and practically free from silk. The brine should be nearly clear.

*Extra Standard.*—Corn of this grade should stand midway in quality between Fancy and Standard grades. It is somewhat difficult to describe in words, the quality of this grade. Corn, which but for some slight defect would otherwise be graded as Fancy, or Standard corn having some especially fine quality, would come under this grade.

*Standard.*—Corn of this grade in Maine style should be reasonably tender, of fairly good color, or only slightly brown in color,



and nearly free from silk, bits of cob or husks. It should have the flavor characteristic of young sweet corn, or have only a slightly cooked taste. Its consistency should be thick and creamy, with no separation of liquor.

In corn of this grade in Maryland style the kernels are somewhat tougher, but of good flavor and reasonably free from silk. The brine is nearly clear with a tendency to milkiness.

*Sub-Standard or Seconds.*—This grade in Maine style consists of hard, tough grains of poor flavor and appearance.

Corn of this grade in Maryland is packed from material too tough and mature for standard grade. This grade is not suitable for Army use.

*Number of Cans Per Ton.*—On the average 500 cans per ton, up to 25 cases (600 cans); 3 tons to acre on land that will yield 50 bu. of field corn.

### CORN, DRY PACK OR MAINE STYLE.

Set the machine to cut off about one-third of the grain and to scrape the remainder; pass through the silker; place in mixer and add enough syrup (Sugar, 8 lbs.; Salt, 5 lbs.; Water, 25 gals.) to give it the desired consistency; then cook, fill, seal and process No. 2 cans 1 hour at 250 degrees. Cool cans in retort.

### CORN, FANCY.

Use a double-cut corn cutting machine, or after corn comes from the silker subject it to the action of a recutter, then pack and process same as above; the consistency, however, being heavier as a rule, and the corn more tender, due to careful selection before cutting. Handle and process same as above.

### CREAM OF CORN.

Score every grain of corn and scrape out the pulp, run through the silker, place in mixer and add sufficient syrup (Sugar, 7 lbs.; Salt, 6 lbs.; Water, 25 gals.); handle and process same as above.

### CORN, FRANCO-AMERICAN STYLE.

Prepare same as cream of corn, using same syrup. While in the mixer add for each gallon of corn pulp  $\frac{1}{4}$  oz. ground white pepper and  $\frac{1}{2}$  pound melted butter. Handle and process same as above.

### CORN, WHOLE GRAIN OR MARYLAND STYLE.

Cut the entire grain from the cob, which usually is done by hand; remove all silk, place in can, and add syrup (Sugar, 6 lbs.; Salt, 5 lbs.; Water, 25 gals.); seal and process No. 2 cans 50

minutes at 250 degrees. Cool in retort. If cans are filled with cold syrup, exhaust No. 2 cans 10 minutes at 212 degrees, and process 40 minutes at 250 degrees.

### DANDELION GREENS.

Gather the leaves before the plant blossoms, wash well and crisp in cold water; blanch 3 minutes in boiling water, place in cans, and add hot brine (salt, 1½ lbs.; water, 12½ gals.). Seal and process at 240 degrees, No. 2 cans 30 minutes, No. 3 cans 40 minutes; at 212 degrees, No. 2 cans 60 minutes, No. 3 cans 75 minutes.

### ENDIVE.

Handle and process same as dandelion.

### HOMINY.

No. 3 Standard—Minimum gross wt., 39 oz. and 28 oz. hominy after draining; can filled to one inch of top when drained. Prepared from medium-sized white corn, and to contain not more than 5 per cent. of black tips.

No. 3 Fancy.—Minimum wt., after draining, 22 oz.; contents ½ inch from top of can; 2 per cent. black tips; prepared from selected white corn.

### HOMINY WITH TOMATO SAUCE.

Place two bushels half-grain hominy in a 50-gal. barrel; then nearly fill with a solution of Bicarb. Soda, 1 oz. in 12½ gals. water; soak 12 hours, then drain off surplus liquid. Place the hominy in a tank fitted with a closed coil, cover with cold water, bring to a boil and simmer, without stirring, 5 hours, or until the hominy is soft; drain off the surplus water, and to each 100 lbs. add 2 gals. of the following sauce:

- 30 gals. Tomato Pulp.
- 10 gals. Water (in which hominy was cooked).
- 6 lbs. Salt.
- 12 oz. Ground White Pepper.

Place in cans while hot, seal, and process, No. 3 cans, 90 minutes at 240, or 2½ hours at 212 degrees.

### HOMINY, PLAIN.

Treat and cook as for Hominy with Tomato Sauce, except that barely sufficient water is used to cover it, and it is stirred frequently while cooking; when the hominy is soft and the water has assumed a creamy consistency, add 1 lb. of salt and 1 oz. ground white pepper



to each 100 lbs. Place in cans while hot, seal, and process same as above.

### HOMINY AND SAUSAGE.

Treat and cook as for hominy plain; prepare the sausage, which should be of the small "frankfurter" size, in the same way as used with sauerkraut, first boiling it, and place several in each can. Handle and process same as above.

### KALE.

Wash well in cold water to free from sand and dirt, pick out all dead leaves, blanch in boiling water 5 minutes, chop fine, fill in cans and add hot brine (salt 2 lbs., water 12½ gals.). Seal and process No. 3 cans 20 minutes at 240 degrees.

### MUSHROOMS.

Have the mushrooms as freshly gathered as possible and of even size; wash to free from dirt; peel and throw in bath containing 1½ oz. Sulphite of Soda and 12½ gals. water. Blanch 3 to 4 minutes in a bath of water 12½ gals., salt 5 lbs., citric acid 1 oz.; place in cans with hot brine (salt 2 lbs., water 12½ gals.); seal, and process at 240 degrees, No. 1 cans 10 minutes, No. 2 cans 12 minutes.

### OKRA.

This article is somewhat extensively packed for soup purposes, but is one of the articles in cans which should have a much larger demand. If it were properly put before the consuming public, there can be no doubt but that its sale would be greatly increased, because it is in large request among housekeepers.

Okra can be easily grown and could be canned and placed upon the market at a figure which would bring it within the reach of all, and yet show a neat profit to the packer.

Wash the okra in cold water; blanch 20 minutes in boiling water, cut in transverse slices, rejecting the hard ones and the tough stem end, place in cans, fill with cold brine (salt 2½ lbs., water 12½ gals.). Seal, exhaust No. 2 cans 10 minutes at 212 degrees, No. 3 cans 15 minutes at 212 degrees. Process No. 2 cans 25 minutes at 240 degrees, No. 3 cans 35 minutes at 240 degrees.

### OKRA AND TOMATOES.

Wash, blanch and cut the okra, place the prepared okra in a jacketed kettle and mix with it an equal bulk of peeled and cored tomatoes, turn on steam; bring to a boil and cook 15 minutes; place in cans, and process No. 2 cans 15 minutes at 240 degrees; No. 3 cans 20 minutes, at 240 degrees.

## PEAS.

In peas we have one of the most important packs of the industry, it being classed among the "staple" articles. While this is the case, however, this article cannot be grown and packed with success in every section of the country, for it will be found that not every section turns out a quality of pea which will pack well, and this has caused the packing of this article to be largely confined to certain sections. Experience has taught the growers and packers of these sections that Nature is kind to the pea there, and that when properly handled in the packing house a fine article can be produced.

The mechanical inventions have possibly been more noted in connection with this article and of more benefit to it than any other single article connected with the business, and they have all tended to not only increase the output, with a saving in time and labor, but to increase the quality of the goods. This is so true that it is now recognized that without these improved mechanical devices it is impossible to pack peas profitably.

Having acquainted himself with all the requirements of this pack and equipped his factory in such manner as to be able to handle the crop rapidly and thoroughly, the packer may consider himself ready, though the first year's pack may be expected to fall below his expectations.

## CANNED PEA STANDARDS.

## FOOD INSPECTION DECISION 173.

## Canned Vegetables, Canned Peas and Canned Pea Grades.

The following definitions and standards for canned vegetables, canned peas and canned pea grades were adopted by the Joint Committee on Definitions and Standards, April 25, 1917, and were approved by the Association of American Dairy, Food and Drug Officials August 3, 1917, and by the Association of Official Agricultural Chemists November 21, 1917:

1. Canned vegetables are properly matured and prepared fresh vegetables, with or without the addition of potable water, salt and sugar, as specified in the separate definitions for the several kinds of canned vegetables, sterilized by heat, with or without previous cooking in vessels from which they take up no injurious substance, and kept in suitable, clean, hermetically sealed containers.

2. Canned peas are the canned vegetables prepared from the well-developed but still tender seeds of the common or garden pea (*Pisum sativum*) by shelling, winnowing and thorough washing, with or without grading and with or without pre-cooking (blanching) and by the addition, before sterilization, of the necessary amount of potable water, with or without sugar and salt.



## CANNED PEA VARIETIES.

3. Early peas are peas of early maturing sorts having a smooth skin.
4. Sugar peas, sweet peas, are peas of later maturing varieties having a wrinkled skin and sweet flavor.

## CANNED PEA GRADES.

5. Fancy peas are young, succulent peas of fairly uniform size and color, unless declared to be ungraded for size, with reasonably clear liquor, and free from flavor defects due to imperfect processing.

6. Standard peas are less succulent peas than the "fancy" grade, but green and of mellow consistency, of uniform size and color, unless declared to be ungraded for size, with reasonably clear liquor, though not necessarily free from sediment, and reasonably free from flavor defects due to imperfect processing.

7. Sub-standard peas are peas that are over-mature, though not fully ripened, or that lack in other respects the qualifications for the standard grade.

No. 1 peas are peas which were, before precooking (blanching), small enough to pass through a screen of  $9/32$ -inch (7 mm.) mesh.

No. 2 peas are peas which were, before precooking (blanching), small enough to pass through a screen of  $10/32$ -inch (8 mm.) mesh.

No. 3 peas are peas which were, before precooking (blanching), small enough to pass through a screen of  $11/32$ -inch (8.7 mm.) mesh.

No. 4 peas are peas which were, before precooking (blanching), small enough to pass through a screen of  $12/32$ -inch (9.5 mm.) mesh.

No. 5 peas are peas which were, before precooking (blanching), small enough to pass through a screen of  $13/32$ -inch (10.3 mm.) mesh.

No. 6 peas are peas not all of which were, before precooking (blanching), small enough to pass through a screen of  $13/32$ -inch (10.3 mm.) mesh.

The foregoing definitions and standards are adopted as a guide for the officials of this department in enforcing the Food and Drugs Act.

D. F. HOUSTON,

Secretary of Agriculture.

Washington, D. C., February 15, 1918.

Peas are not among the easy goods to process and keep, but among the most difficult so far as turning out a uniform product with clear liquor is concerned. Not only do the peas of one year's growth differ from another, but they also vary considerably during the same season, so that frequent cutting of processed cans and close and constant inspection of each step in the various operations is necessary that the processor may be guided in changing the fill of cans and the process time to produce a pack of uniform quality and appearance.

The process times given here are a fair average, but the processor should bear in mind that peas grown during a wet season will require a shorter process than those grown during a dry season; also, as a rule, the later in the season the peas are planted, the more process they require. The processor should aim to turn out a finished article that is fit for table use by simply heating through, to contain no broken or bursted peas, and with a perfectly clear

liquor. In filling cans, more young peas than old will be required; if cans are filled too full, some of the peas will burst and produce cloudy liquor. For filling cans use a 3 per cent. brine, though by many sweet brine (3 per cent. salt, 2 per cent. sugar) is considered an improvement on plain brine. If peas are picked at the proper time, brought promptly to the factory and then speedily and properly handled, the natural color of all the better grades will be quite sufficient to satisfy the sensible consumer.

In common with most vegetables, peas are much improved by crisping in cold water, and even peas which are badly wilted will turn out of fair quality if given a long bath in cold water and the blanching time slightly increased.

The packing of peas, except on such a small scale as has no commercial significance, is confined to power factories, and, while the vining machine has practically displaced the old hulling machine in many sections where peas are drilled and harvested much the same as wheat, it is rather a question if the old and new methods combined will not give better general results.

Following this plan, we install in our factory a pea huller, and outside, opposite the cleaner, under a temporary shed a viner to be run by an independent engine. A traction or portable engine will prove economical and efficient for this purpose. Place the huller in blocks bounded by 1 to 5 and 61 to 64; the cleaner in numbers 5 to 8 and 65 to 68; the separator in 9 to 12 and 69 to 72; the washer in 79 to 103 and 75 to 99, and the blancher in 84 to 108 and 80 to 104. Then place the picking tables in numbers 110 to 122 and 115 to 127, and the filler in 117 to 119 and 165 to 167, delivering directly to steam exhaust box in 168. After the shelled peas come from the huller or viner, run through the cleaner, which removes all the dust and pieces of stems, etc.; then through the separator, which divides the peas into uniform sizes; then each size must run through the washer which should empty into the blancher, which, in turn, empties onto the picking tables, where the women remove all the broken peas, the black eyes or yellow peas, the thistles, etc., as the peas move before them on the rubber belts. These tables empty into large buckets, which are picked up and emptied into the hoppers of the fillers. Here the cans are filled and brined automatically, passing into the exhaust box before going to the closing machines.

Exhaust the filled cans in steam box, bringing the temperature to as near 170 degrees as possible. Process No. 2 cans:

|                                 |                            |
|---------------------------------|----------------------------|
| No. 1 size or Petit Pois,       | 15 minutes at 240 degrees. |
| No. 2 size or Extra Early June, | 16 minutes at 240 degrees. |
| No. 3 size or Early June,       | 20 minutes at 240 degrees. |
| No. 4 size or Sifted June,      | 25 minutes at 240 degrees. |
| No. 5 size or Sifted Garden,    | 28 minutes at 240 degrees. |
| No. 5 size or Marrowfats,       | 30 minutes at 240 degrees. |



Sizes No. 1 and No. 2 can stand a longer process without being damaged, and there are those who advocate a reversal of the above times on that account, giving the short time to the large peas and the longer time to the small peas; but in general we advocate the above times, with such variations as local or peculiar conditions may make necessary.

Peas are nearly always packed in No. 2 cans.

### PEA SOUP STOCK.

The yellows and black eyes may be utilized for soup. Cook soft in jacketed kettle, pass through pulping machine and make immediately into soup or pack in gallon cans for that purpose—fill in the cans hot, seal and process 45 minutes at 240 degrees.

Off peas may also be dried and afterward ground into pea meal. This article is largely used on shipboard and in public institutions for soup-making. Cut the pods and vines, and store in silos for feeding stock.

When a plant is intended for packing peas and corn exclusively, a three-story building should be erected, arranging the various machines so that one will discharge into the other.

### THE CANNING OF PEAS

---

*Based on Factory Inspection and Experimental Data.*

---

BY

A. W. BITTING,

WHILE FOOD INSPECTOR, BUREAU OF CHEMISTRY.

---

*Historical Note.*—According to the early accounts of the art of canning, peas were among the first vegetables to be preserved in this manner, and later they were among the first to enter the canned foods trade. Pea canning may be said, therefore, to be as old as the canning industry. At first the process was used only to preserve such choice fruits and vegetables as were most difficult to keep in the fresh state, as the cost of glass bottles and earthenware jars prevented their use for cheaper products. After the invention of the tin can, as the cost was lessened, peas became one of the most important articles packed. The pea-canning industry began in this country in Baltimore during the Fifties. There was an immediate demand for the product, and consequently some packing was done at nearly every factory. The peas were grown garden fashion and picked and podded by hand, but the labor required was so great that the output was small and the price high. The methods used did not differ in any essential detail from those followed in preparing fresh peas

in the kitchen. The demand continued to increase, but the total output of all the early factories would not equal that of one small modern plant.

The first labor-saving device of importance in pea canning was the podding machine invented by Madame Faure in France in 1883. This machine was described in *La Nature*, Paris, April, 1885, and a translation, with illustrations, appeared in the *Scientific American* June 6, 1885. The invention was practically duplicated in this country in 1889. By means of the podding machine one person could do the work of a hundred or more in removing the peas from the pods, thus making possible the canning of much greater quantities. The American podding machine was improved and in 1893 it was patented as a vining machine. After this invention it was no longer necessary to pick the pods from the vines in the field; the plants could be mowed, hauled in by wagon, and the peas separated from the pod and vine at one operation. The whole pea-canning industry was changed by this invention. Practically all of the peas canned in this country are passed through these vining machines, so that their use has virtually changed the growing of peas in small patches—market-garden fashion, with hundreds of persons going over the vines and picking the pods—to the cultivating of large fields which are cut by a machine. The viner occupies the same relation to hand picking in the pea-canning industry that the threshing machine does to the flail in the threshing of wheat.

Pea canning is one of the most important lines of the canning industry, being third in order of output, tomatoes and corn being, respectively, first and second, although peas are second in point of value. The pea pack for 1907 is estimated at 6,505,961 cases, valued at \$14,650,000, the largest amount ever packed in one season.

## THE PEA.

### ORIGIN AND CHARACTERISTICS.

The pea belongs to the Leguminosæ, an order of plants which is of great economical value, as many of its members yield foods, drugs, dyes and valuable woods. Chief among their products are peas, beans, lentils, peanuts, tamarinds, licorice, senna, gum tragacanth, gum arabic, logwood, indigo, rosewood, locust and Brazil wood.

The origin of the pea is unknown, but it is supposed to have been carried to Europe by the Aryans at a remote period. The field pea, *Pisum arvense*, is found wild in Italy, but the garden pea, *Pisum sativum*, grows only under cultivation, so far as known. In Queen Elizabeth's time peas were occasionally brought from Holland and considered "a dainty dish for ladies; they came so far and cost so dear." The taste for green peas became fashionable after the Restoration in 1660, and their culture was given much attention, later becoming so general as to be one of the most important field crops. Garden peas were considered a delicacy, and the French gave considerable attention to their culture and canning, and through selection they developed varieties yielding tender small peas of fine flavor. The pea was brought to North America by European colonists, and grown in kitchen and market gardens.

### FOOD VALUES.

Of all the vegetables known the legumes are the richest in respect to their nitrogenous content, Knight going so far as to claim that they will be found equal to meat in nutritive powers for active open-air workers. Statements of this nature are not true of green peas, but apply to the mature seeds only. The following analyses show the results obtained on the mature peas, and also on the green pea before and after canning:



*Results of analyses of peas.*

## DRIED PEAS.

| Analyst.                  | Water.<br>Per Ct. | Protein.<br>Per Ct. | Fat.<br>Per Ct. | Starch, etc.<br>Per Ct. | Cellulose.<br>Per Ct. | Ash.<br>Per Ct. |
|---------------------------|-------------------|---------------------|-----------------|-------------------------|-----------------------|-----------------|
| Abela <sup>a</sup> .....  | 9.50              | 24.60               | 1.00            | 62.00                   | ....                  | 2.00            |
| Church <sup>b</sup> ..... | 14.30             | 22.40               | 2.50            | 51.30                   | 6.50                  | 3.00            |
| Knight <sup>c</sup> ..... | 14.31             | 22.63               | 1.72            | 53.24                   | 5.45                  | 2.65            |
| Payned .....              | 8.30              | 23.80               | 2.10            | 58.70                   | 3.50                  | 2.10            |
| Wiley <sup>e</sup> .....  | 12.62             | 27.04               | 1.58            | 51.75                   | 3.90                  | 3.11            |

## GREEN PEAS.

|             |       |      |     |        |      |      |
|-------------|-------|------|-----|--------|------|------|
| Abel .....  | 74.60 | 7.00 | .50 | f16.90 | .... | 1.00 |
| Wiley ..... | 79.93 | 3.87 | .49 | 13.30  | 1.63 | .78  |

## CANNED PEAS.

|             |       |      |      |       |      |      |
|-------------|-------|------|------|-------|------|------|
| Abel .....  | 85.30 | 3.60 | 0.20 | f9.80 | .... | 1.10 |
| Wiley ..... | 85.47 | 3.57 | .21  | 7.79  | 1.18 | 1.11 |

<sup>a</sup>Abs. Friedenwald and Ruhrah, *Diet in Health and Disease*, p. 91, 1905.

<sup>b</sup>Food, p. 83, 1887.

<sup>c</sup>Food and Its Functions, 1895.

<sup>d</sup>Abs. Pavy, F. W., *Food and Dietetics*, p. 167, 1881.

<sup>e</sup>Foods and Their Adulteration, pp. 288, 313, 1907.

<sup>f</sup>Including cellulose.

According to these figures, the average amount of protein in the dry peas is 24.09 per cent., indicating that the canned peas lost some protein during the preliminary treatment. Leach states that 2.03 per cent. of the protein of the pea is soluble in water, and 10 per cent. is salt solution. These figures were evidently for the mature pea. Church states that the predominating protein in leguminous plants appears to be more soluble and more easily digested in the green than in the mature seed. In the preparation of peas for canning, they pass through a washer, where they are sprinkled with cold water, and then go to the picking tables, still wet, and after this into the blancher containing hot water. The length of time that the peas are in the washer varies in the factories, while the time they remain in the blancher depends upon the grade and size of the peas, varying from one to twelve minutes. After leaving the blanchers, the peas are placed in the cans as quickly as the machines will work, and the brine is filled in at the same time. From the treatment it is apparent that the peas may lose some protein before entering the cans, and that more may dissolve in the brine after they are in the cans. A part of the loss of protein in canning is, however, more apparent than real, as the peas take up in blanching and processing, thus increasing their total weight, which only seemingly reduces the proportion of protein.

The liquor from peas which had been canned in water, and also liquor from peas canned in brine, were tested for protein. While the reactions with the water extract indicated distinct traces of protein, those with the brine were much more pronounced. Some of the canners advise the use of the original pea liquor in the preparation of the peas for the table, supposedly with the object of utilizing the extracted foods. Usually the liquor is discarded as being somewhat objectionable in order.

## GEOGRAPHICAL DISTRIBUTION.

While the growing of peas is not limited to any one particular part of the United States, they are grown with the greatest success where the spring is a little slow in changing from cool to warm weather. The northeastern and north central parts of the country grow most of the peas, Wisconsin leading in their production, closely followed by New York. These two States produce almost one-half of the entire pea pack of the country. Indiana, Michigan, Maryland, Illinois, New Jersey, Delaware, Ohio, California, Pennsylvania, Iowa, Minnesota, Virginia and Kansas follow in order. Peas are also being packed in Colorado, Idaho, Utah, and Oregon, but they cannot be grown in the Southern States nor in many places in the Central and Western States in competition with those grown near the Lakes, as the period of harvesting is too brief and other hazards of the crop are too great. Pea packing is rapidly increasing in Wisconsin and Michigan, because of favorable climatic conditions for production.

## PRODUCTION OF PEAS ESPECIALLY FOR CANNING.

It is said that the different seed firms list about 300 varieties of garden peas, or at least give that many names. The varieties used by most canners are Alaska and Little Gem for the early or smooth varieties, and Horsford's Market-Garden, Admirals, and Advancers for the late or wrinkled varieties. The smooth varieties are not as sweet as the wrinkled.

It would seem as though much improvement might be made in peas through breeding and selection for increased sugar content, fine texture, pleasing flavors, and smaller peas. These are qualities especially sought by the trade. To stimulate a greater sugar content, sugar is added to the liquor, but the other requirements can only be obtained by proper growth. The possibility of developing a plant with greater resistance to climatic changes, especially heat, and of lengthening the season of development are also worthy of special study.

## TIME AND MANNER OF HARVESTING.

In Indiana, Illinois, Ohio, and States of similar climatic conditions the period of harvesting for the factory is less than twenty days, and seed will not mature to advantage on account of weevils. In Michigan and Wisconsin the harvest period is from six to eight weeks, and the seed readily matures. Ninety per cent of all the pea seed for planting is produced in northern Michigan. The irrigation system in Colorado and Utah have opened up possibilities in pea growing, the extent of which is not known at this time.

*The average dates for harvesting peas for a series of years.*

| State.          | Date.              | State.            | Date.              |
|-----------------|--------------------|-------------------|--------------------|
| California..... | May 20 to June 20  | New York.....     | June 15 to Aug. 1  |
| Colorado.....   | June 15 to Aug. 15 | Ohio.....         | June 1 to July 10  |
| Delaware.....   | May 25 to June 30  | Oregon.....       | June 10 to July 30 |
| Illinois.....   | June 10 to July 14 | Pennsylvania..... | June 1 to July 1   |
| Indiana.....    | June 5 to July 10  | Utah.....         | June 10 to July 15 |
| Maryland.....   | May 25 to July 1   | Virginia.....     | May 20 to June 10  |
| Michigan.....   | June 15 to Aug. 10 | Wisconsin.....    | June 15 to Aug. 10 |
| New Jersey..... | June 1 to July 3   |                   |                    |

A longer harvesting period in the Northern States is possible because successive plantings can be made of the same varieties as well as of early and late varieties. In the more southern areas the crops are too liable to mature at one time—late-sown peas as early as the first sown—thereby overcrowding the factory.



Peas were formerly gathered by hand. Five pods usually form upon each vine, and the lowest is only about 10 inches above the ground. This part of the work was, therefore, very slow and laborious, and requires an amount of help available to but few factories. At present there is only one large factory known to the writer employing hand labor in the picking of the peas. It requires about two thousand pickers to keep a large factory in operation, and adds a cost of about 1.5 to 2 cents to each can.

The method in general use is to cut the vines with a mowing machine, or, if any are exceptionally erect, to use the self-rake reaper. If the mowing machine be used, then it must be followed immediately by men with forks to bunch the peas in order to prevent trampling by the horses, and to put them in condition for easy loading. Within the past year or two special attachments have been devised to be connected to the mowing machine for the purpose of bunching and delivering to one side. The cutting is usually done early in the morning, and only such part of the field is cut as can be delivered promptly to the viner. The object is to prevent any heating of the vines or any drying. The vines are loaded upon wagons, like hay, and hauled to the vining machines.

#### GRADING AND VALUATION OF CROP.

The basis on which peas are paid for varies greatly at the different factories. Many pay a flat price, so much per bushel or hundred pounds of shelled peas. When this plan is pursued it is advantageous to the factory to insist on the peas being delivered as young as it is possible to use them in order to get the maximum amount of small peas, but it is to the farmer's advantage to delay hauling them in order to get an increase in growth and weight. Such a method is not fair to either factory or producer, neither is it fair to the different producers, one with a first-class load and another with an over-ripe load.

A second method is to have a scale of prices for two or three grades of peas. The rating of any given load is made by an expert and is a matter of judgment. The appearance of the vines, the size of the peas, the hardness to the sense of touch when squeezed between the fingers, and sometimes the taste are the factors which guide in the decision. Such a method is manifestly better than a flat rate of so much per bushel, but it is not nearly so accurate as could be desired and is also subject to personal bias.

A third method is to pay two or more prices, according to the percentage of peas of a given size. A half-gallon measure of peas is taken out of a given load and poured into a box having a bottom perforated with No. 3 holes. If, as the result of shaking, one-half or more of the peas pass through the sieve and they are fairly soft the second price is paid; if the peas be over-ripe or hard the lowest price is paid. This method is used by a number of factories, and, although not perfect, is an improvement over the other two.

A fourth method is to take a sample from each load during the thrashing and run it through the grader. The sample usually weighs 10 pounds, and the screens in the grader corresponds to those used in the factory. The weights of the five grades are taken separately and the price is established upon the percentage of the different sizes of peas. Some factories modify this procedure slightly by rating Nos. 1 and 2 together and Nos. 4 and 5 together, thus making three grades in size as the basis for payment. The greater the percentage of the smaller sizes of peas, the higher the price paid for a bushel. This method seems the fairest of those now in general use.

The fifth method for payment is based upon quality, rather than upon size, as in three of the methods described, in which it is assumed that small size is associated with immaturity and tenderness, an assumption which is not always in accordance with facts. Large peas may be as soft and tender as the small ones, and small peas may be as hard as those that are over-ripe. This method consists in taking a few vines as a sample from each load, shelling

the peas and placing them in a cylinder which has a perforated bottom and is suspended in a salt solution. If the peas are young and tender a large percentage will float in a weak brine. If they are older or second grade they will sink in a light solution, but will float in a heavier one. If old, hard or over-ripe they will sink in the heavier solution. The density of these solutions is varied within narrow limits for the early and late varieties of peas, and is discussed in more detail under grading in the factory.

This method is expeditious, and experience has shown that it is as nearly accurate in practice as the fourth method of grading based on size. The ideal grading system should be based on a combination of size and weight.

## FACTORY OPERATIONS.

### VINING OR THRASHING.

The separation of the peas from the pods and vines is accomplished by a single operation. The viner is an ingenious though simple piece of mechanism, consisting of an outer cylinder having perforations of such size that peas will pass readily through, but which will retain the pods and vines, and an inner cylinder upon which there are paddles or beaters. The outer cylinder is made to revolve slowly in one direction, and the inner one at a high rate of speed in the opposite direction. The vines are fed in at one end of the cylinder and are carried up by the slower-moving outer cylinder until they fall off, and in so doing strike the paddles upon the rapidly revolving inner cylinder. The impact of the paddle causes the pod to break open and the peas to be thrown out. The process is repeated again and again as the vines work from one end of the cylinder to the other. The peas are discharged through the perforations of the outer cylinder and the vines at the opposite end. The work is done thoroughly and the peas are not bruised or crushed by the operation, as might be expected. As a further aid in separating the smaller bits of stems, leaves, etc., the peas fall from the cylinder upon a moving web placed at such an angle that the peas will readily roll down into the receiver, while the flat leaves and other particles which will not roll will be carried off.

The vining machines are supplied to the different factories upon a royalty basis, the charge being 3 cents per dozen cans for all shell peas put up at the factory. These machines are large and, as a rule, are set in batteries at the factory instead of being taken to the fields. A few of the very large factories have established vining stations at varying distances from the factory and bring in the shelled peas by wagons, automobiles, or rail. This practice requires rapid handling, as the peas will heat much more quickly after than before being shelled. A large saving in the hauling of vines is effected, and the injury to the peas is probably not greater than would occur in letting the vines wait. These viners were formerly fed by hand, but recently a mechanical feeder has been devised, so that the vines are pitched off the load and the machine completes the work. An automatic weighing device has also been added to take the place of the pea collector and weigher, and conveyors are used to carry all vines to the stack or silos so that the actual hand work is reduced to a minimum.

Shelled peas which are hauled to the factory must be kept in thin layers rather than in bulk. The best carrier seems to be a box about 6 inches deep, having a raised wire bottom made like that of a berry box. The layer of peas is only about 4 inches thick and is well ventilated. The boxes or crates, no matter how constructed, must be sterilized with steam and rinsed with scalding water each day or they will become infected with germs which will cause spoilage.

### WASHING.

The first operation through which peas pass after being weighed from the viner is that of washing. This is accomplished in what is known as the squirrel cage, which is a wire cylinder about 3 feet in diameter and 12 feet



long. The cylinder is set on a slight incline so that when the peas are admitted at one end they will tend to roll to the other as the cylinder revolves. On the inside is a perforated pipe that sprays a stream of water upon the peas, which insures their being well washed, provided the spray has some force. When the weather is very warm and the peas accumulate more rapidly than they can be passed through the filler, it may be necessary to wash the shelled peas in cold water every few hours in order to prevent fermentation. The washing should be thorough, not only to remove all dirt, but also the mucous substance, thus insuring a clearer liquor.

#### GRADING FOR QUALITY.

After the peas pass through the washer, they should be graded according to the degree of maturity or hardness. This is accomplished by passing them through tanks containing salt solutions of different densities. It has been found that the young, tender peas will float in a salt solution somewhat heavier than water, and those more mature will sink, while the very mature peas will sink in a heavy salt solution. Peas, therefore, may be sorted very readily into different grades according to their density by using different strengths of salt water. In practice three grades have been made. The first grade consists of all peas which will float in a solution having a specific gravity of 1.040. The second grade consists of those peas which will sink in a solution of this density but which will float in a solution having a specific gravity of 1.070. The third consists of the peas which will sink in the latter solution. A machine has been devised to remove the peas from the top and bottom of these solutions so that their separation is automatic and continuous.

The principle involved in the separation of peas into grades for quality is not new, having long been applied to the selection of seeds. It was tried for grading peas for several years without success, because solutions having the proper density were not obtained and the necessary working apparatus was not available. On May 27, 1894, a patent was granted on a device for grading peas, which has since been improved so as to work very well.

The grading of peas for quality is as sharp and clear as that for size. The lightest weight peas are the finest, being even in quality, succulent, and tender. The heaviest peas are the poorest, being uneven in quality, hard, overripe, and of bad color. The middle-weight peas are good, but harder than the first grade, of darker color, and not so uniform. These differences are most apparent before the canning is done, though they are readily distinguishable in the can, and also show on chemical examination.

In any load of peas there must be some plants more mature than others, and, as a consequence, some hard peas will be mixed with the tender ones. Every effort is made to cut the peas at nearly the same state of maturity, but no field will ripen perfectly evenly. If the peas be produced by a hundred farmers, the differences will be accentuated. In localities where the peas mature slowly, the differences will be less marked than where they mature rapidly. Under any conditions there will be some differences in quality, and under unfavorable conditions the percentage of poor peas may be very high. Separation for quality is so well effected by the specific gravity grader that it undoubtedly will receive a recognition equal to that given the sizing machine.

According to an Indiana factory, in which the quality system of grading has been developed, peas rated good and poor upon the wagon gave the following results after passing through the grader:

*Quality grading compared with wagon tests.*

| Grade.<br>1906— | Rated good on wagon.<br>Per Cent. | Rated poor on wagon.<br>Per Cent. |
|-----------------|-----------------------------------|-----------------------------------|
| First .....     | 60.60                             | 40.20                             |
| Second .....    | 20.75                             | 20.59                             |
| Third .....     | 18.65                             | 39.21                             |
| 1907—           |                                   |                                   |
| First .....     | 51.10                             | 26.35                             |
| Second .....    | 28.85                             | 37.76                             |
| Third .....     | 20.05                             | 35.89                             |
| 1908a.          |                                   |                                   |
| First .....     | 28.85                             |                                   |
| Second .....    | 43.34                             |                                   |
| Third .....     | 30.81                             |                                   |

*a* Whole crop rated by grader in this year.

Had the specific-gravity system not been in use the output of first-class peas would have been much smaller and that of second and third grades correspondingly increased. The trade permits a small percentage of hard and off-size peas in the first grade, but with this system these "off" peas are very few. The characteristics of the different grades will be considered again under the finished product.

A chemical examination of peas graded for quality as well as for size results as shown in the following table:

*Chemical examination of peas graded for size and quality.*

(Analysis made in the Division of Foods, Bureau of Chemistry.)

| Grade.             | Total solids. | Ash. | Crude protein | Crude fibre. | Pentans. | Starch | Sucrose | Reducing Sugar | Undetermined |
|--------------------|---------------|------|---------------|--------------|----------|--------|---------|----------------|--------------|
| <b>Petit pois:</b> |               |      |               |              |          |        |         |                |              |
| First .....        | 14.23         | 1.03 | 3.44          | 1.68         | 0.75     | 5.57   | 0.72    | 0.00           | 1.04         |
| Second .....       | 18.80         | 1.78 | 4.19          | 1.84         | 0.92     | 8.53   | 0.93    | 0.00           | 0.61         |
| Third .....        | 18.44         | 1.82 | 4.41          | 2.28         | 0.94     | 8.53   | 0.817   | 0.00           | 0.357        |
| <b>Sifted:</b>     |               |      |               |              |          |        |         |                |              |
| First .....        | 22.06         | 1.36 | 5.31          | 2.21         | 0.96     | 10.23  | 0.987   | 0.00           | 1.012        |
| Second .....       | 24.32         | 1.04 | 5.69          | 2.05         | 1.01     | 11.52  | 0.57    | 0.00           | 2.44         |
| Third .....        | 27.74         | 1.37 | 5.63          | 2.18         | 1.50     | 13.52  | 0.48    | 0.00           | 3.06         |
| <b>Marrowfat:</b>  |               |      |               |              |          |        |         |                |              |
| First .....        | 22.22         | 1.02 | 5.13          | 2.18         | 0.98     | 10.48  | 0.94    | 0.00           | 1.49         |
| Second .....       | 24.10         | 1.30 | 6.69          | 2.55         | 1.55     | 8.77   | 0.636   | 0.00           | 2.604        |
| Third .....        | 27.15         | 2.03 | 5.94          | 2.00         | 1.27     | 12.91  | 0.361   | 0.00           | 2.639        |

The table shows more total solids and higher protein and starch content in the third-grade goods. This might be expected, as the third grade represents the more mature product. If canned peas were purchased for their nutritive properties only, then the third grade would be the preferable one to



buy, but they are usually selected for their delicacy and flavor, which are found in the highest degree in the youngest and tenderest peas, or the first grade.

GRADING FOR SIZE.

The grading for size is a very simple matter. The peas are passed over sieves, or into a revolving cylinder having four sections with perforations of different sizes. The perforations in the first sieve or section measure nine thirty-seconds of an inch in diameter. The peas which pass through this size opening are known as No. 1, or "petits pois." The next size of perforation is ten thirty-seconds of an inch in diameter, and the peas passing through are known as No. 2 "extra sifted," or "extra fine." The third size of perforation is eleven thirty-seconds of an inch, and the peas which pass through are known as No. 3 "sifted or fins." The last size is twelve thirty-seconds of an inch, and the peas which pass through are known as No. 4, or "early June" peas. The peas which are too large to pass through this sieve go over the end and are known as No. 5, or "marrowfats." Some packers add one more sieve for late peas, with perforations thirteen thirty-seconds of an inch in diameter for the No. 5, and those which pass over this sieve are called No. 6, or "telephone peas." The sizes of these perforations are standard and in general use. Some packers have attempted to make sizes of their own by reaming out the holes; while others do not use all four sieves, but group two sizes together; and some peas are ungraded.

These sizes are so nearly standard for all pea packing that they should be adhered to in the labeling. The term "early June" peas as now used applies to a certain size and not to the season at which the peas are picked, and the size larger, or "marrowfat," should not be labeled "early June." "Extra early June" or "May pickings" is not a proper designation for sifted peas. It is evident that the standard terms used to designate size should be employed in labeling if the proper meaning is to be conveyed to the purchaser. Commercially, almost any size of pea may be found to be selling as "early June" in the cheaper grades. The more expensive peas are usually sold true to name, though it is not unusual to get smaller peas in the high grades than is indicated upon the label. The terms "early June," "May pickings," "extra early June," and others of that character could be advantageously supplanted by names more distinctive of size, as the present terms conflict with the requirements of the food and drugs act as to labeling, unless the product be actually packed at the time indicated.

The percentage of peas which go into the different sizes will vary considerably with the time of harvesting, the variety, and the season. One of the large factories furnishes the following figures upon the crops for 1906 and 1907:

*Percentage of different sizes in the crops for two years.*

| Size.                 | 1906.            | 1907.            |
|-----------------------|------------------|------------------|
|                       | <i>Per cent.</i> | <i>Per cent.</i> |
| 1. Petits pois .....  | 4.00             | 7.60             |
| 2. Extra sifted ..... | 7.50             | 12.20            |
| 3. Sifted .....       | 30.30            | 34.70            |
| 4. Early June .....   | 50.20            | 28.10            |
| 5. Marrowfat .....    | 8.00             | 17.40            |

It is not known how these figures will compare with the grading for the entire country, as this is a matter which canners do not make public.

## HAND PICKING.

After the peas have been graded into sizes they are usually run in thin layers over slowly moving belts, so that pieces of foreign material, broken, fully matured, and defective peas may be seen easily and removed. Low-grade peas are not so carefully picked over.

In the section of the country where Canada thistles are abundant, their separation is a difficult problem, as the thistle top is about the same size as the pea, and only the very large ones are removed by the graders. During the last season experiments were made in removing the thistle tops by the specific gravity system, and it was found that more than 90 per cent. of them would float in a light brine (having a density of 1.020), while only a small percentage of peas floated in such a solution. It is evident, therefore, that instead of employing hundreds of girls to perform this work, more than 90 per cent. of the tops could be collected in less than 10 per cent. of the peas. The reduction of the tedious hand labor by such a method is apparent. These tests were made too near the close of the season to be completed, but sufficient work was done to demonstrate the correctness of the principle. The work can also be very materially reduced by separating the thistles from the vines at the vining machine.

## BLANCHING.

There are two objects in blanching peas: (1) To remove the mucous substance from the outside and a part of the green coloring matter, so as to have a clear liquor in the can; and (2) to drive water into the peas so that all will be tender.

In the young, juicy pea, the water content is at its maximum, so that the cleaning of the surface is all that is necessary. The time required for blanching is from one-half to one minute for No. 1 and No. 2, or "Petits pois" and "extra sifted;" one and a half minutes for No. 3, or "sifted;" two minutes for No. 4, or "early June," and two and one-half minutes for No. 5, or "marrowfat" peas. To get the best results, peas which are old and hard will need a blanch approximately five times as long as young peas of the corresponding grade, while those in the intermediate stages will require a blanch proportional to their development.

It is evident, therefore, that among peas that are good, but ungraded as to quality, there will be a greater or less number which will be hard because of under blanching, and some above size because of swelling during the blanching and after processing. There is no part of the work of canning peas which requires so much judgment as that of blanching if the best quality of goods is to be obtained. Much of the very cheap goods upon the market are made so because of following "rule of thumb" methods in this department. The division of peas into grades for quality as well as for size will simplify somewhat the problem as to the length of time that blanching should be continued, but not to the point of making the position of blancher one of secondary importance in the canning factory.

Experiments were made to determine the effect of varying periods of blanching on the different sizes and grades of peas, and the influence exerted on swelling, tenderness, color of the liquor and fill of the can. While the primary object was to determine the relation of blanching to spoilage, the secondary effect on the commercial grading was evident.

Young peas will stand either a long or short blanch better than old ones. The effect upon the increase in size was determined by running the peas over the same size screens before and after blanching, and noting the percentage which did not pass through. It was found that after a ten-minute blanch the percentage which showed an increase in size was as follows:



*Percentage of peas increased in size by blanching for ten minutes.*

| Size of Peas.     | Grade 1.         | Grade 2.         | Grade 3.         |
|-------------------|------------------|------------------|------------------|
|                   | <i>Per cent.</i> | <i>Per cent.</i> | <i>Per cent.</i> |
| Petits pois ..... | 28               | 45               | 82               |
| Sifted .....      | 26               | 42               | 56               |
| Marrowfat .....   | 24               | 42               | 68               |

The increase in size was much greater in grades 2 and 3 than in grade 1. The experiments with the one-minute blanch and the five-minute blanch were not made upon complete sets, but the results obtained indicated a similar change, though it was less marked.

The peas were filled into the can so as to give a uniform weight, and water was added without salt or sugar, to give a total of 660 grams. After processing it was found that of those given the short blanch, the peas in grade 1 had taken up but little of the liquor, and those in grades 2 and 3, particularly the latter, had taken up so much of the water as to leave an insufficient amount to cover the peas in the can.

The appearance of the liquor was best on grade 1 for the one-minute blanch, and good for the five-minute and ten-minute blanches; on grade 2 it was best for five-minute blanch, and on grade 3 best for the ten-minute blanch. The liquor on grade 1 was clear, on grade 3 cloudy but thin, and on grade 3 thick and starchy. The peas in grade 3 for the one-minute blanch had formed a solid mass with the liquor so that half of the peas would not fall out when the can was inverted.

Tender peas which are overblanched, soften, break open, and discharge free starch grains so as to make a muddy liquor, and if in great excess, the liquor in the bottom of the can becomes pasty. Old peas which are underblanched remain hard and unpalatable after processing, or, if given a hard process, they will take up all the liquor in the can and become a more or less thickened mass. Such peas never have clear liquor. If the tender and hard peas be mixed, and the blanching be set for the young peas, the older ones are not well done; if set for the older peas, the tender ones are overdone. It follows, therefore, that to get good results requires much judgment, and a system of blanching tests could possibly be worked out to advantage.

The operation of blanching peas is of comparatively recent introduction in the pea-packing process and at first was thought to be an unnecessary step. When the liquor was unattractive, the peas were placed in loose bags or perforated buckets and suspended in hot water for a short time, after which the water was drained off. From this practice the operation of blanching developed, and at present a number of blanching devices are on the market. Those seen in operation are of two types. In the older one the peas are held in a wire basket which is suspended in a trough of hot water. The trough is usually long, and mechanical devices are arranged to carry the baskets through at such a speed as will insure their being given a certain length of time for the different sizes. These tanks vary from 20 to 80 feet in length. The second type of blancher is that of the continuous washer. A cylinder is made to revolve in a shallow tank of water, and if run at a given speed the peas will be delivered at the opposite end in a given time. Some of these cylinders are sectioned in order to have cleaner water as the blanching progresses. The hot water is admitted at one end and the waste escapes from the opposite end. The raw peas and the water enter opposite ends of the trough so that the clean peas do not come in contact with the dirty water. From a sanitary standpoint, this is the better type of apparatus, though in practice the trough blanchers are probably the more economical, but not so cleanly.

## POKE STALKS.

Select stalks not over 4 inches long, and showing but a single tuft of leaves at the top. Wash and crisp in cold water, tie in bundles and blanch 2 minutes in bath containing salt  $\frac{3}{4}$  lb., water  $12\frac{1}{2}$  gals. Place in side opening cans, fill with brine ( $2\frac{1}{2}$  lbs. salt,  $12\frac{1}{2}$  gals. water). Solder lids and exhaust No. 2 cans 9 minutes, No. 3 cans 10 minutes. Tip and process at 240 degrees, No. 2 cans 25 minutes, No. 3 cans 30 minutes.

## PUMPKIN.

As with many other articles, if the public were but educated to the use of canned pumpkin; told that such a thing may be gotten, that in the canned article the housekeeper is freed from all the bother and worry of preparing the green article, and has the "ready-for-use" pumpkin right at hand, the demand would easily be found.

Pumpkin can be obtained and canned at a comparatively low figure, though arrangements must be made with the growers beforehand, so as to assure a crop. Coming, as it does, after the rush season of canning, and being an article which will keep indefinitely in its green state, all the time and care necessary to the production of a fine article may be given to it. Pumpkin should be grown cheaply, as it can be sown on the same ground and at the same time as corn, coming in when the corn has been removed.

In the packing of this article there is one machine which has played and still plays a most important part—the Cyclone Pulp Machine. This machine converts the pieces of cooked pumpkin into a fine pulp or paste, a condition which is essential with this article.

There is a large amount of pumpkin put up in No. 10 cans for pie-making purposes, but the most popular style is the No. 3 can, which is suitable to family use.

## THE FORMULA.

Open the pumpkin and remove the seed; cut the flesh in pieces of convenient size and steam in a retort or closed tank until soft. Permit the water to drain through a rack or balse bottom; pass through a rotary pulper place the resulting pulp in white hot cans, or if it becomes cool, exhaust No. 3 cans 10 minutes at 212 degrees; and process 90 minutes at 250 degrees. It is preferable that all pumpkin be pulped rapidly and filled into the cans hot, rather than to exhaust.

Should the pulp thus obtained be too thin and watery, the water may be evaporated by any appropriate method.

Gallon or No. 10 cans, exhaust 15 minutes at 212 degrees, tip and process 40 minutes at 240 degrees.



If processed in open bath, would give pumpkin 75 minutes at 212 degrees with 10 minutes exhaust. This time may be shortened if the pulp is partly cooked in a jacketed kettle before placing in the cans to one hour. This for No. 3 cans.

### OLD JERSEY STYLE PUMPKIN BUTTER.

Peel and clean the pumpkins, cut in small pieces and boil in water until thoroughly cooked. Pass through pulping machine. Place 100 gals. off this pulp in jacketed kettle with 50 lbs. sugar,  $\frac{1}{2}$  lb. ground cinnamon and  $\frac{1}{4}$  lb ground ginger. Cook down to a butter thick enough to stand while hot. Pass through finishing machine. Some think the addition of a few sliced lemons improve the flavor.

### RHUBARB.

Wash in cold water, cut in pieces 1 to  $1\frac{1}{2}$  inches long, place in cans, fill in hot water, seal, and process at 240 degrees, No. 3 cans 5 minutes, No. 10 cans 12 minutes; at 212 degrees, No. 3 cans 15 minutes, No. 10 cans 25 minutes.

### SALSIFY.

Wash and scrape the roots; as soon as scraped, throw in a bath containing 1 oz. Sulphite of Soda in  $12\frac{1}{2}$  gals. water. Blanch 5 minutes in boiling water, place in cans and fill with hot brine (salt 2 lbs., water  $12\frac{1}{2}$  gals.); seal and process No. 2 cans 40 minutes at 240 degrees.

### SAUER KRAUT.

No. 3 Standard—Minimum gross wt. of can, 39 oz. and 24 oz. of well-cured kraut; reasonably dry;  $\frac{1}{8}$ -inch wire mesh used for draining.

Sauer kraut has met with considerable favor, and the extent of the pack is rapidly increasing. Those who are in a position to put down their own "kraut," as is done in many sections, should be able to can and place this article on the market at a profit.

The following sauer kraut recipe is from one of the largest kraut manufacturers in Germany, where the celebrated Magdeburg sauer kraut is made. To get the sweetish-sour flavor it is necessary to cut the core in with the kraut. This can only be done by using a core cutter.

First remove the outer green leaves of the heads, then the core is taken out with the corer, *but far superior kraut is attained by using a core cutter*, whereby the core is utilized instead of going to waste. The heads are then put in the kraut cutter, to be cut in the longest, finest strings possible, which can be done if the core is left in. The kraut must be put in the barrels or vats as soon as possible

after it has been cut, as too long exposure to the air without being salted will impede the fermentation of the kraut. Cabbage exposed to the air after being cut is also apt to turn grey or black.

The bottom of the sauer kraut barrel should be lined with loose cabbage or grape leaves. Then a layer of the cut cabbage about 6 inches deep is put in and strewn with salt and a few juniper berries. The amount of salt used not to exceed 4 per cent. of the amount of cabbage (in weight—4 lbs. salt to 100 lbs. cabbage). After the layer of cabbage is salted, it is pressed or stamped down firmly and evenly, by which process the air, which prevents the proper fermentation of the kraut, is expelled. In this manner layer upon layer is packed in until the barrel is filled. The cabbage is then covered with a perforated hardwood cover, which is weighted down with stones or a press attached to the barrel, to prevent air from coming in contact with the kraut. *Always keep the kraut covered with brine.*

The sauer kraut ought to ferment in the brine for a period of about three to four weeks. That the fermentation process has ceased is best ascertained by the fact that no more gas bubbles are noticed. If the kraut has arrived at this stage, it ought to remain undisturbed for about four or five days longer, and then be filled into tubs.

By salting, the greatest part of the water contained in the cells of the cabbage is extracted, and in combination with the salt forms the brine.

Kraut requires the most careful attention while it is in the state of fermentation. It will not ferment well in too cool a place, 59 to 70 degrees is about the right temperature. After the kraut is fermented it will keep best in a cool place.

That the cabbage may ferment more speedily, some manufacturers add one tablespoonful of skimmed sour milk to each barrel of kraut. This is put in with the kraut as it is cut and put in barrels.

It is figured that one ton of good, solid cabbage makes four whiskey barrels full of kraut, and that one barrel of this kind will fill 250 No. 3 cans. Thus one ton of cabbage will produce about 1000 No. 3 cans of kraut.

*The Formula.*—Remove the kraut from package and wash thoroughly with cold water; place in kettle or tank with closed coil; cover with cold water, adding 10 lbs. of salt pork for each 100 lbs.; bring to a boil and cook slowly three hours. Remove the pork, cut in thin slices and place a slice in each can; fill the can with the kraut while still hot; seal and process No. 3 cans one hour at 240 degrees.



### SAUER KRAUT, WITH VIENNA SAUSAGE.

Handle same as above, substituting very small Vienna sausage for the pork. Give the sausage a preliminary cook of one hour, instead of three hours, as in the case with pork.

### SPAGHETTI.

Boil the spaghetti for 20 minutes in 200 gallons water with 16 pounds of salt. Drain off water and cool for 20 minutes. Make a smooth sauce of the remaining ingredients, keep hot and agitated until all is used. Put about 7 oz. of the spaghetti in a No. 2 can and fill with the sauce, process at 220 degrees Fahrenheit for one hour.

The average net weight should be ascertained and stated on the label. The statement, "Heat the can in boiling water for 15 minutes before serving" should also appear on label.

Italian style spaghetti with cheese and tomato sauce:

*Formula.*

|                                           |          |                 |
|-------------------------------------------|----------|-----------------|
| Spaghetti—High-grade domestic .....       | 200 lbs. | } <i>Sauce.</i> |
| Cheese—English dairy variety, grated..... | 40 lbs.  |                 |
| Creamery butter .....                     | 14 lbs.  |                 |
| Whole tomato pulp sp. gr. 1035.....       | 50 gals. |                 |
| Sugar .....                               | 40 lbs.  |                 |
| Salt .....                                | 24 lbs.  |                 |
| White pepper .....                        | ½ lb.    |                 |
| Paprika (optional) .....                  | ½ lb.    |                 |

### SPINACH.

This article seems to find a quite ready market and at good prices, but it must be packed with care and handled in the proper manner. It is generally put up in No. 3 cans, though also in No. 2, and there is an extensive trade among hotels and restaurants in No. 10 cans.

The Bureau of Chemistry on May 15, 1918, set the following weights for spinach:

The weights given are minimum "cut-out" weights, that is to say, the weight of drained spinach remaining after the contents of the can have been drained on a 1/8-inch mesh screen for two minutes, or longer if necessary, to secure complete draining. It is expected that due allowance will be made by canners for shrinkage so that the finished product will have a "cut-out" weight of not less than that specified. The cut-out weights are as follows:

|                 | Diam. in inches. | Height in inches. | "Cut-out" weight<br>in ounces. |
|-----------------|------------------|-------------------|--------------------------------|
| No. 2 Can.....  | 3 3/8            | 4 9/16            | 16                             |
| No. 2½ Can..... | 4                | 4 3/4             | 24                             |
| No. 3 Can.....  | 4 3/16           | 4 7/8             | 26                             |
| No. 10 Can..... | 6 3/32           | 6 3/16            | 85                             |

Have spinach delivered to factory in splint baskets or slatted crates. If necessary to store on floor, do not make piles more than three feet deep.

In preparing, first pick off all dead leaves; break or cut leaves from stems; wash thoroughly in cold water to crisp and remove all earth and grit; blanch two minutes in boiling water; pack in cans; fill with hot 3 per cent. brine; seal and process:

No. 3 cans, 30 minutes at 240 degrees.

No. 3 cans, 40 minutes at 212 degrees.

No. 10 cans, 2 hours at 212 degrees.

Cool cans after processing.

Steaming may replace the blanch, and in the power factory, for washing and steaming spinach, a power washer and scalding are used to advantage.

### SQUASH.

Handle and process same as pumpkin.

### SUCCOTASH.

Pack same as Maine syle corn, adding to the corn while in mixer 20 per cent. to 33 1-3 per cent. young Lima beans. Process No. 2 cans 60 minutes at 250 degrees, and cool in retort.

Dried Lima beans may be used with the green corn, but must be labeled as such, under the pure food laws.

### SWEET POTATOES.

This article in recent years has attained to quite an extensive pack, and demand has kept pace with it. Like pumpkin, this also offers the progressive packer an opportunity to increase the extent of his packing along a profitable line.

Sweet potatoes are difficult to pack, and require considerable attention and care, because, if not handled properly, an unsightly poor article will result. There are two styles of packing, one being the whole potatoes, packed as dry as possible, the other being pie stock, in which the sweet potato appears as a pulp.

The difficulty in packing the first style is to keep the potatoes dry; that is, so that they will cut out from the can comparatively dry; by which is meant that they must not be in a soft, mushy, water-soaked condition. As will be seen in the formulae below, it is necessary to parboil the potatoes, and the nature of this vegetable is to absorb water. Therefore, care should be taken to select a good quality of potato, one which will cook "dry," as it is termed. Different packers resort to different methods to obtain this result, some even placing the parboiled potatoes in a pan and running them into an oven for a short time, thus virtually baking them. But this



method is almost too expensive, and is not advised, except for "extras" and the finest packs.

The formula given here have been in use for a number of years and have given general satisfaction. But in this, as with all other articles, care should be taken to cook a trial batch of goods in order to test the quality of the stock you are working on, for a difference in soil, fertilizers used, etc., will make a difference in the texture of the potato, and this must be overcome by such slight modification of the directions, that is, in the time, as may be required.

*It has been found that almost every section of the country has to employ a different time of process owing to wide variations in the nature of the potatoes, and great care must be exercised in this respect.*

Difficulty has been encountered with this article in not having the heat properly penetrate the entire contents of the can, because sweet potatoes seem to possess a strong resistant power to heat. Here is a point to watch, for the cans must be heated through their entire contents in order to secure proper sterilization.

In preparing the second class, or pie stock, all the potatoes are available. Because, however, of the difficulty to get the proper heat throughout the can, some packers have taken to running the pulp through a corn cooker and filler, and have stated to us that they secured better results in this way. The formula given below for this class of foods will be found satisfactory under all ordinary circumstances.

*Formula.*—Select yellow-skinned potatoes; place in steam bath and cook until about  $\frac{3}{4}$  done. Scrape off the skin, holding the potato in hand, which protect with a cloth or heavy mitten. Do not hold on a fork to skin; if the potatoes are punctured with any pointed instrument, they will cut out watery after processing; place potatoes in can while still hot, packing as solidly and closely as possible. Seal and process No. 3 cans 70 minutes at 240 degrees.

### SWEET POTATO PULP (FOR PIES).

Wash the potatoes and rub off rootlets, cook one-half hour in steam bath or boiling water, pass through rotary pulping machine; place the resulting pulp in cans while hot; seal and process 70 minutes at 240 degrees for No. 3 cans.

### TOMATOES.

Tomatoes have been termed "the poor man's meat," and are, in connection with the pulp, the most important item handled by canned food packers. There are more packers handling this article than any other single article in the entire list; and, as a consequence, the total output of canned tomatoes is far in excess of all

others. Many factories handle this crop alone, packing nothing else; a great number handle it together with corn, but nearly all factories handle tomatoes in some manner, as the regular canned article, as an article of especially fine packing in glass, or use the pulp in connection with baked beans, catsup, soups, or in some of the numerous ways in which tomatoes or pulp can be used. While the use of the tomato in this respect was, up to a few years ago, entirely confined to the Continent of North America, it may now be said to be of universal use wherever canned foods are put up.

As years go by the amount packed and consumed is greatly increasing, as is shown by the fact that twenty years ago a pack of 5,000,000 cases (figured on No. 3 cans, 24 cans to the case) was considered a large pack, whereas in recent years it has averaged about 16,000,000 cases, more than three times the above figures, and the consumption has kept pace with this increase. It cannot be expected, however, that this rate of increase will continue, but it is a fact that there is room for still further increase in the number of cases put up, but the consumer must be educated to the use of the canned article, and there can be no education so effective as the packing of good goods.

Quality is always the most important factor the canner has to consider, whether he is new in the business and just starting, or whether he has been long in the industry, for, as the canning of tomatoes affords the greatest opportunity for evil, because it is the greatest pack in extent, quality must be the keynote of that industry. Besides, it is only the part of wisdom for the packer to keep his quality up, for, if he allows it to go down, his business will go with it. Packers, of course, cannot pack all extra tomatoes and expect to sell them at extra prices, for there is the demand for cheaper goods to be filled; but let him be honest in what he does, labeling his extras as extras, his standards as standards and his seconds as seconds, and not attempt to label his seconds as standards, and even extras, as is sometimes done, thus deceiving the consumer; for, while he may succeed in such methods once, he will not again, for he will not have the chance.

In the canning of tomatoes there are, perhaps, more methods employed than in any other article; that is, in respect to the mechanical working of the factory. In the beginning of the industry the only piece of machinery, so to call it, in the factory was the process kettle; the scalding in hand baskets, the peeling, the filling into cans, the capping and the tipping were done by hand labor.

Other tomato-canning factories are almost entirely mechanical throughout, these being the latest production in their line.

The peeling of tomatoes has long been a knotty question, defying the attempts of our best inventors, for it has seemed impossible to secure a mechanical device which would do the work well and rapidly. Thus the tomato packing house is compelled to secure



a large number of hands as "peelers," and the situation of the factory has, therefore, to be such as can command a large supply of help. This is, perhaps, a more serious question than that of the growing crop, for in the average the acreage can be secured, but if arrangements have not been made beforehand for a good supply of reliable help, the packer may find that he cannot secure it.

### A CLEAN TOMATO CANNERY.

The recent regulations adopted by the National Cannery Association, and which, it may be said, are the basis upon which food inspectors work, should be carefully read in connection with this. They are given in the forepart of this book, under General Directions.

### THE OPERATION.

Tomatoes should be delivered to the factory when thoroughly red ripe (but not overripe), in shallow, slatted crates, 7 to 8 inches deep, with hand-holes cut in each end. They should not be carted in deep boxes or conical splint baskets in which the weight of the fruit on top will crush or bruise the bottom layer. There are specially contrived carriers for tomatoes, and the progressive packer should have his own supply of these, which, when "picking time" comes, can be loaned to the growers and returned by them when picking and hauling are finished. A record must be kept of such, and the grower held responsible for the good condition of the carriers.

### SCALDING.

The proper scalding of tomatoes is an operation to which frequently too little attention is given; and often defects in the pack can be traced to improper scalding and delay in handling after scalding.

Keep the scalding up to the peelers, but not ahead of them. Many cases of swells have been traced to scalding, or rather a partial cooking in water that was not actually boiling, the long immersion and consequent softening and heating of the flesh making an excellent medium, in first-class condition, for the development of certain germs that are not destroyed by the ordinary processing.

The best method of scalding is with a machine, or machines, so arranged that the tomatoes are first washed in warm water, then subjected to the action of jets of live steam for just a sufficient period to properly start the skin, and are then plunged immediately into cold water before being delivered to the peelers. When tomatoes are scalded in water in a tank, the water must be at an actual, active jumping boil in order to obtain the best results, and, if afterward they are given a bath in cold water, an effect almost equal to steam scalding may be obtained. Tomatoes thus chilled

with cold water, after either steam or water scalding, will be firmer and pack a more solid can, will enable the peelers to work more rapidly, and will avoid some bacteriological complications which are apt to occur if tomatoes are scalded too far ahead of the peelers. The scalded fruit may be delivered to the peelers in buckets, but no scalded tomatoes should be delivered to a peeler until all the previous supply is skinned.

In many recent investigations an undue loss by "swells" has been traced to the stationary bins used in some systems for holding the supply of scalded tomatoes for the peelers, and which, when nearly empty, are replenished with a fresh supply. As a consequence, it is quite possible that a portion of the first delivered are the last skinned, and this may cause a variety of trouble, especially where the tomatoes have not been cooled after the scalding.

### PEELING.

In peeling tomatoes, always remove the core first, using a knife with a short, narrow blade, holding it in such a manner that the point will reach near the center of the tomato and slanting the blade at the stem sufficiently to cut out the harder portion of the core, but not enough to cut into and open up the seed cells. If the seed cells are cut slightly, solid pack cannot be made. Even when the tomatoes are so green at the stem end that much of them has to be cut away, insist that your peelers remove the cores in this manner and afterwards cut away the green portions; it will save a large percentage of waste.

### SCALDING AND PEELING TOMATOES.

By W. C. SMILEY.

In some respects I shall speak to you from the experience and to the interests of the smaller canner. Some of the principles I shall advance may not be applicable to those who are more extensively engaged in the business, they may not be practical, but to the smaller canner they are essentially so.

First, if the conditions of the weather are such as to permit it, if the nights are dry and cool, the fruit should be allowed to stand in the yards or somewhere in the shade for at least twenty-four hours after gathering before going to the scalding. This setting in the shade helps to color up the fruit and causes the peel to loosen from the pulp, so that when they go to the peeling table and are peeled they present a beautiful smooth surface. They will scald more quickly when they have been allowed to stand awhile, which also proves a great advantage to the fruit. In scalding we prefer the open vat scalding, as we believe it has some advantage over the continuous scalding.



When the scalding is in use the water should be kept as hot as water can well be made, so as to make the scald as quickly as possible. A sufficient amount of water should be kept in the scalding basket to keep the tomatoes from packing in the bottom of the scalding basket. The boil of the water should keep the fruit moving in order to get a uniform scald. After the tomato has been in the scald something like a quarter or half a minute (the time should be judged by the condition of the fruit) they should be raised and aired a few seconds. This causes the peel to contract and break, releasing the steam that gathers just under the peel, and keeps it from penetrating and softening the tomato. After airing a bit they should be let back into the water a few seconds again to finish the scald; then they are ready to go to the peeling table, where they should be spread out enough to allow the steam to escape while being peeled.

Now, permit us to explain the advantages of a quick scald over a slow one. In a slow scald you heat the tomato through to the seed cells and loosen the substance about the seed, soften the pulp, and draw the juice of the tomato to the surface, thus making it difficult for the peeler to hold, making it necessary for them to squeeze the tomato in the hand in order to hold it while removing the stem. This squeezing the tomato forces the juice and softened pulp to the stem end, and when the peeler cuts into it a large per cent. of the pulp and juice runs out and is wasted. The peel adheres to the softened pulp, making it almost impossible for the peeler to remove the stem and peel without tearing the tomato to pieces. Where, on the other hand, if the tomato is scalded quickly it does not get hot sufficiently deep to soften it and the peelers can remove the stem and peel without damage or waste of fruit.

Care should be taken not to allow the tomatoes to become piled in bulk while hot, as that would have a tendency to soften them. Some canners use the individual box and give each peeler a bushel or half bushel, as the case may be. We don't approve of this from the fact the tomatoes in the bottom of the individual box will soften before the peeler can get to them.

Every precaution should be taken to keep the fruit from getting too hot before it goes to the packing table or machine in order to keep it firm and get a solid pack.

The demand of the trade is becoming more for quality than for quantity, and it is entirely to the canner's interest to get the tomato in the can as nearly whole as possible, not from the standpoint of a good standard only, but from the point of business economy. Thousands of dollars of raw material go out over the peeling table in waste every year that should otherwise be added to the canners' profits.

The manager of every factory should give strict attention to his peeling department to see that the tomatoes are not unnecessarily chopped up and wasted. Great care should be used in peeling not to

open the seed cells when it is possible to avoid it, as deep cutting cause a double waste. In the past few years I have spent quite a bit of time at the peeling tables personally and have made a close study of that branch of the business, and find it of vital importance. The first essential in peeling tomatoes is to be careful in removing the stem to cut shallow, and run the knife as close in to the stem as possible. This avoids waste and leaves the tomato in its natural shape. Of course we advocate the spoon-shaped or concave knife for peeling. Experience has long taught us its value as a time and fruit saver. The straight-blade knife is clumsy and awkward to handle, putting into the peeler's hands too great a temptation to waste the fruit by unnecessary cutting, while the concave knife fits the ball of the thumb, which acts as a guard against deep cutting and can be run close into the stem, making a clean-cut job and with no damage or waste of fruit.

Proper scalding and reasonable care not to expose the seed cells in peeling will not only raise your quality, but will greatly reduce your cost price, add to your profits and serve to strengthen the industry.

---

Should your daily pack average less than 15 No. 3 cans per bushel, look first to your peelers, then to the scalding and then to the tomatoes as received.

After peeling carry to the packing machine, where place them on a perforated table level with the top of the hopper, for examination and draining off surplus juice. Make suitable provisions for saving this juice and that from the packing machine, for use in high-grade catsup and baked beans. There is more flavor in this juice than in the pulp of the tomato, and whenever possible it should be utilized.

After filling the can solidly with fruit, press down the tomatoes to allow for the expansion during the exhaust and process. At this point in the operation it is advisable to have a set of scales and frequently test cans to see that they are averaging the standard weight; this is the place to correct weight, not after the cans are sealed. *Exhaust No. 3 cans ten minutes at 212 degrees, in a continuous steam exhauster.*

From the moment the tomatoes are scalded until in the process kettle they must be kept constantly moving. At the noon hour get all into the process kettle before stopping. *Peeled tomatoes standing in buckets in their own juice will frequently ferment in half an hour, and in cans which have been exhausted, unsealed, in 10 to 15 minutes.*

DIFFERENCES in climate, soil and fertilizers make important changes in the chemical and physical properties of tomatoes, AND UNDER NO CIRCUMSTANCES SHOULD A LARGE PACK BE MADE IN A SECTION WHERE CONCLUSIVE PRELIMINARY TESTS HAVE NOT BEEN MADE.



## STANDARDS.

FOOD INSPECTION DECISION 144: The text of this decision is as follows:

*Use of water, brine, sirup, sauce and similar substances in the preparation thereof. The can in canned food products serves not only as a container, but also as an index of the quantity of food therein. It should be as full of food as is practicable for packing and processing without injuring the quality or appearance of the contents. Some food products may be canned without the addition of any other substances whatsoever—for example, tomatoes. The addition of water in such instances is deemed adulteration. Other foods may require the addition of water, brine, sugar or syrup, either to combine with the food for its proper preparation or for the purpose of sterilization—for instance, peas. In this case the can should be packed as full as practicable with the peas and should contain only sufficient liquor to fill the interstices and cover the product.*

*Canned foods, therefore, will be deemed to be adulterated if they are found to contain water, brine, syrup, sauce, or similar substances in excess of the amount necessary for their proper preparation and sterilization.*

*It has come to the notice of the department that pulp prepared from trimmings, cores and other waste material is sometimes added to canned tomatoes. It is the opinion of the Board that pulp is not a normal ingredient of canned tomatoes, and such addition is therefore adulteration. It is the further opinion of the Board that the addition of tomato juice in excess of the amount present in the tomatoes used is adulteration—that is, if in the canning of a lot of tomatoes more juice be added than is present in that lot, the same will be considered an adulteration.*

The above F. I. D. 144 is the only recognized standard for tomatoes, as for most other articles, but particularly as regards tomatoes. When the Government was the large buyer for Army and Navy supplies, during the war, it issued the following as its buying standard for tomatoes: "Tomatoes to be sound and ripe, free from artificial coloring matter, and packed without the addition of water, tomato pulp, or of tomato juice in excess of the amount normally present in the tomatoes. Weight of No. 3 (4 $\frac{7}{8}$ "') cans, not less than 2 lbs. 1 oz."

## GRADES.

*Extra Fancy Tomatoes* should consist of prime ripe fruit having a fleshy body, well-developed flavor, and uniform red color. The tomatoes for the most part should be whole, and free from peel, cores, or defects. If large pieces of good quality are present in

small quantity in extra fancy tomatoes, they should not be cause for rejection.

*Extra Standard Tomatoes* should consist of prime ripe fruit of fairly fleshy body, good flavor, and of few, if any, green, yellow, or off-colored pieces. The majority of the tomatoes should be whole, or in large pieces, well peeled, cored, and trimmed.

*Standard Tomatoes* should consist of fully matured, sound, ripe fruit, of fair body and good flavor. The color may be somewhat irregular, and the tomatoes broken, but they should be well peeled, cored, and trimmed. Green, immature fruit in standard grade, or better, is not permissible and when found is cause for rejection.

*Seconds or Soup Stock* usually consist of a mixture of green, immature tomatoes, pieces and parts more or less green in color, and soft, over-ripe stock.

### SIZE AND NET WEIGHT OF CANS.

Tomatoes purchased for the Army are packed in No. 3 and No. 10 cans. The No. 3 can, standard for Army use, is  $4\frac{7}{8}$  inches in height. Since tomatoes are the one product packed in all sizes of cans, the fills for the other sizes of No. 3 cans have been given below. The following minimum net weights are required:

| <i>Size of Can.</i>         | <i>Net Weight.</i>                         |
|-----------------------------|--------------------------------------------|
| No. $2\frac{1}{2}$          | Not less than 1 lb. 12 oz. (equals 28 oz.) |
| No. 3 ( $4\frac{7}{8}$ in.) | Not less than 2 lb. 1 oz. (equals 33 oz.)  |
| No. 3 (5 in.)               | Not less than 2 lb. 2 oz. (equals 34 oz.)  |
| No. 3 ( $5\frac{1}{2}$ in.) | Not less than 2 lb. 6 oz. (equals 38 oz.)  |
| No. 10                      | Not less than 6 lb. 7 oz. (equals 103 oz.) |

### THE PROCESS.

No. 1 Cans,

No. 2 Cans, 8 minutes at 240 degrees; 25 minutes at 212 degrees.

No.  $2\frac{1}{2}$  Cans,

No. 3 Cans, 10 minutes at 240 degrees; 30 minutes at 212 degrees.

No. 9 Cans,

No. 10 Cans, 20 minutes at 240 degrees; 60 minutes at 212 degrees.

Time in continuous cooker.



## TOMATOES, WHOLE.

Select firm, solid tomatoes of can-hole size, wash carefully and place in can, fill with cold brine (Salt, 1 lb.; Water, 12½ gals.). Exhaust, seal and process 35 minutes at 212 degrees.

## CANNED TOMATOES, THEIR COMPOSITION.

| Lab. No. | Capacity,<br>Can cc. | Net Weight ozs. |       | Solids<br>ozs. | Water<br>ozs. | Percent Water in |       | Dry Matter     |               |               | Per cent<br>Solids in can |
|----------|----------------------|-----------------|-------|----------------|---------------|------------------|-------|----------------|---------------|---------------|---------------------------|
|          |                      | Claimed         | Found |                |               | Solids           | Juice | Solids<br>ozs. | Juice<br>ozs. | Total<br>ozs. |                           |
| 7539     | 1000                 | 33              | 34.12 | 15.87          | 18.75         | 90.76            | 93.86 | 1.466          | 1.151         | 2.617         | 7.67                      |
| 7540     | 1000                 | 33-35           | 31.87 | 11.37          | 20.50         | 94.24            | 96.87 | .655           | .641          | 1.296         | 4.06                      |
| 7541     | 1050                 | 35-37           | 33.12 | 18.44          | 14.69         | 88.65            | 92.23 | 2.093          | 1.141         | 3.233         | 9.79                      |
| 7542     | 1000                 | 33              | 33.75 | 17.37          | 16.37         | 91.27            | 95.87 | 1.516          | .676          | 2.192         | 6.49                      |
| 7543     | 1000                 | 30              | 33.56 | 16.44          | 17.12         | 87.55            | 95.23 | 2.067          | .817          | 2.883         | 8.59                      |
| 7544     | 1000                 | 33-35           | 32.75 | 16.19          | 16.56         | 91.34            | 95.00 | 1.302          | .828          | 2.130         | 6.50                      |
| 7545     | 1150                 | 40-44           | 39.62 | 19.87          | 19.75         | 92.13            | 94.78 | 1.564          | 1.031         | 2.595         | 6.55                      |
| 7546     | 1170                 | 2lb 14 oz.      | 40.06 | 17.81          | 22.25         | 87.82            | 93.74 | 2.069          | 1.393         | 3.462         | 8.63                      |
| 7547     | 1070                 | 35-37           | 35.13 | 20.19          | 14.94         | 90.04            | 93.28 | 2.011          | 1.064         | 3.075         | 8.75                      |
| 7551     | 1000                 | 32              | 33.00 | 15.88          | 17.12         | 93.20            | 95.85 | 1.080          | .709          | 1.789         | 5.42                      |
| 7552     | 1000                 | 31-32           | 31.94 | 11.63          | 20.31         | 94.84            | 97.52 | .610           | .504          | 1.114         | 3.48                      |
| 7553     | 1025                 | 30-34           | 33.19 | 16.50          | 16.69         | 90.40            | 94.24 | 1.584          | .961          | 2.545         | 7.65                      |
| 7554     | 1000                 | 31-33           | 34.00 | 17.50          | 16.50         | 91.48            | 93.91 | 1.491          | 1.005         | 2.496         | 7.34                      |
| 7555     | 1000                 | 42              | 33.25 | 20.31          | 12.94         | 92.88            | 95.69 | 1.446          | .558          | 2.004         | 6.02                      |
| 7556     | 1000                 | 33              | 32.62 | 16.87          | 15.75         | 92.13            | 95.29 | 1.328          | .742          | 2.070         | 6.34                      |
| 7556a    | 1200                 | 33              | 41.44 | 22.19          | 19.25         | 93.23            | 95.50 | 1.502          | .866          | 2.368         | 5.71                      |
| 7557     | 1050                 | 32-36           | 35.12 | 18.62          | 16.50         | 91.71            | 94.12 | 1.543          | .970          | 2.513         | 7.19                      |
| 7558     | 1165                 | 40              | 39.44 | 20.66          | 19.38         | 92.84            | 95.13 | 1.436          | .874          | 2.280         | 5.78                      |
| 7559     | 1150                 | 31-34           | 36.81 | 22.06          | 14.75         | 94.39            | 96.17 | 1.237          | .585          | 1.822         | 4.95                      |
| 7560     | 1150                 | 40-42           | 40.62 | 25.06          | 15.56         | 92.19            | 93.98 | 1.956          | .937          | 2.893         | 7.12                      |
| 7561     | 1000                 | 33              | 33.94 | 17.85          | 16.09         | 94.72            | 96.49 | .941           | .568          | 1.509         | 4.44                      |
| 7562     | 1050                 | 32              | 36.00 | 20.37          | 16.62         | 92.12            | 93.89 | 1.604          | 1.015         | 2.619         | 7.27                      |
| 7563     | 1000                 | 31              | 31.87 | 20.38          | 11.50         | 93.27            | 95.73 | 1.371          | .491          | 1.862         | 5.84                      |
| 7564     | 1050                 | 32-36           | 35.93 | 21.31          | 14.63         | 92.51            | 94.97 | 1.596          | .736          | 2.332         | 6.49                      |
| 7565     | 1150                 | 33-35           | 38.37 | 19.87          | 18.50         | 91.11            | 95.69 | 1.766          | .797          | 2.573         | 6.70                      |
| 7566     | 620                  | .....           | 20.67 | 9.44           | 11.44         | 90.89            | 93.79 | .860           | .710          | 1.570         | 7.59                      |
| 7567     | 1150                 | 35-40           | 40.56 | 23.12          | 17.44         | 92.00            | 94.85 | 1.849          | .898          | 2.747         | 6.77                      |
| 7568     | 1040                 | 33              | 32.75 | 14.75          | 18.00         | 93.55            | 96.57 | .953           | .617          | 1.570         | 4.79                      |
| 7569     | 1150                 | 35              | 40.31 | 25.37          | 14.94         | 93.74            | 95.54 | 2.523          | .666          | 3.189         | 7.91                      |
| 7570     | 1030                 | .....           | 34.18 | 16.50          | 17.69         | 90.20            | 94.02 | 1.617          | 1.054         | 2.617         | 7.78                      |
| 7576     | 1150                 | 40-44           | 41.12 | 26.06          | 15.06         | 93.48            | 95.18 | 1.699          | .726          | 2.425         | 5.89                      |
| 7577     | 1000                 | 33-35           | 33.68 | 18.00          | 15.69         | 93.02            | 95.59 | 1.236          | .703          | 1.939         | 5.72                      |
| 7578     | 1000                 | 30              | 33.56 | 13.50          | 20.06         | 92.68            | 95.51 | .988           | .901          | 1.889         | 5.33                      |
| 7582a    | 1030                 | .....           | 35.56 | 18.25          | 17.31         | 93.21            | 95.50 | 1.239          | .779          | 2.018         | 5.67                      |
| Aver'ge  | 1047                 | .....           | 35.11 | 18.38          | 16.78         | 92.04            | 95.04 | 1.476          | .826          | 2.303         | 6.53                      |

Taken from Bulletin, Agricultural Experiment Station, E. F. Ladd, Commissioner, Fargo, N. D.

## TOMATO PULP, SWEET, FROM WHOLE TOMATOES.

Wash and scald the tomatoes and run through rotary pulper, place the resulting pulp in a jacketed kettle with bottom outlet, or in a tank fitted with a closed coil and provided with a draw-off at bottom; at the expiration of 20 minutes to one hour, depending upon the weather, the juice will separate from the solid matter, ordinarily about 25 per cent. of the total bulk, when it is to be drawn off. Turn on steam, bring to a boil, "killing" the foam by adding a small quan-

tity of lard or other sweet grease, and cook 20 minutes, or until the pulp "grains" (that is, when a small quantity is placed on a wooden surface, instead of spreading and presenting a uniformly smooth, watery appearance, it is disposed to gather in a granular mass from which the clear juice "weeps"); then turn off steam; 100 gals. of the average pulp as it comes from the machine will make about 66 gals. sweet pulp of the proper body, or about 50 gals. of finished catsup. Pack in 5-gal. cans.

Do not use skins and cores to make pulp, as the Pure Food Law will condemn it unless all rotten parts, sour scalds, stems, etc., are carefully picked out before pulping. Better throw away the waste and make the skimmers be careful not to waste the fruit when peeling. This will save you money and make better goods.

#### TOMATO PULP, CONCENTRATED OR BOILED DOWN.

Carefully wash (being sure that the washing is sufficient to remove all sand and dirt which collect in the stem end, particularly after heavy rains) sound, dead-ripe tomatoes, and scald thoroughly. Run through pulper and immediately place in jacketed copper kettles, or in wood tanks fitted with closed coils; turn on a full head of steam, "killing" the foam with grease, if necessary; cook rapidly as possible until bulk is reduced one-third, or until the pulp grains; turn off steam, and for each 50 gals. add 6 lbs. salt or more, if the finished catsup or soup formula will allow, and dissolve; run immediately into 5-gal. square cans, cap and tip at once. No process is necessary if the pulp is rapidly handled; as soon as sealed, place in cooling bath. This pulp is suitable for the highest grade of soups, catsups, sauces and baked beans.

Tomato pulp may be kept in cold storage in barrels, without the use of preservatives. Arrange a tank with brine coils, run the pulp in from the kettle and cool to 38 or 40 degrees; then place in barrels and store at same temperature.

Note 1.—In order to secure the best results in natural color and flavor, not less than 60 lbs. steam pressure should be used in jacketed kettles and not less than 80 lbs. pressure when coils are employed. Never reduce tomato pulp on a falling steam pressure.

Note 2.—Instead of "killing" the foam with grease, the better plan is to just cover the jacket with pulp, turn on a full head of steam and bring to a quick boil; with 60 lbs. steam pressure, the violent ebullition will hold foam down; when foam has subsided, open valve of supply pipe and run fresh pulp in so slowly as not to break boil until the kettle is sufficiently charged.

Note 3.—Tell how to avoid having the pulp stick to copper coil.



### TOMATO PULP FOR MEDIUM GRADE GOODS.

Wash and scald the tomatoes, place in a tank containing a 2-inch valve and a 6-inch valve at bottom, and provided with a perforated cross or coil; turn on steam and open 2-inch valve; when the tomatoes have sunk to three-quarters of their bulk, shut off steam and close 2-inch valve; then draw off tomatoes through 6-inch pipe and run through pulper; place the resulting pulp in kettle, give a 10-minutes' boil, then place in barrels or cans. This pulp is used for medium-grade goods.

### TOMATO JUICE, CONDENSED, FOR HIGH-GRADE GOODS.

Strain the juice from packing tables, packing machines, etc., to remove all coarse particles and seeds; place in jacketed copper kettles, bring to a boil and rapidly reduce to one-third its bulk; add salt in proportion of 6 lbs. to 50 gals., place in 5-gal. cans, cap, tip and process 10 minutes at 212 degrees.

This is used for increasing the flavor of high-grade preparations and for making clear tomato soup.

### TURNIPS.

This article is packed to a limited extent, and may be classed among the specialties.

The formula given below is for the yellow variety of turnip, sometimes called the "rutabaga."

Wash and pare yellow turnips, cut in pieces, place in kettle, cover with cold water, bring to a boil and cook 30 minutes; drain off water, pass turnips through pulper. For each 100 lbs. of the pulp, add 2 lbs. salt and  $\frac{1}{4}$  lb. ground white pepper; mix and place in cans while still hot, seal and process No. 2 cans 20 minutes at 240 degrees.

### TURNIP TOPS.

Cut off stems and wash well to remove all grit; crisp in cold water, blanch 2 minutes in boiling water, place in cans and fill with hot brine (Salt, 2 lbs.; Water, 12 $\frac{1}{2}$  gals.). Seal and process No. 2 cans 20 minutes at 240 degrees.

# FRUITS

U. S. Food Standard is:

*Canned fruit is the sound product made by sterilizing clean, sound, properly matured and prepared fresh fruit, by heating, with or without sugar (sucrose) and spices and keeping in suitable, clean, hermetically sealed containers, and conforms in name to the fruit used in its preparation.*

---

There is a constantly increasing demand for fine fruit packed in heavy syrup in small cans. Cannerymen in many sections will do well to pay more attention to this line. Select the choicest fruits for this purpose and pack the inferior in No. 10 cans, in water, for the use of large hotels, bakers and preservers.

The process times given are for fruits in their best condition for packing; for immature fruit slightly increase the time in order to secure softening; for over-ripe, slightly increase the time to secure sterilization.

Immature fruit will present a more attractive appearance when cans are cut, but will lack flavor.

Under the title of Small Fruits come the entire line of berries, ranging from the strawberry, which is about the earliest of all fruits in this line, to the blackberry, cherry, currant, etc. The packing of this line varies in the time of the year, according to the section of the country, for there is no special section laying claim to them, as they are packed in almost every State in the Union and Canada.

The small fruit line of canned goods is one which might be easily increased, and should be immensely popular; but to secure both of these conditions, for one is dependent upon the other, care has to be taken with the packing. There is no more acceptable food product to the masses of the people; but, unfortunately, some years ago, packers slighted this line, packing the berries in the poorest style, with very little fruit in the can and much water. Not all were so packed, but the infection seemed to spread with remarkable rapidity, and few were free from it. The effect of this lack of attention was that small fruits fell into disrepute, were shunned by the public, and, consequently, the market went far below cost. In fact, they were for a while a drug upon the market, and it has only been in the last few years that they have gradually recovered from this setback. In these last few years packers have given them more attention, have packed them with more care, and as a consequence have obtained better prices and the demand is on the increase. If packers would but increase the quality of these goods, they would find the demand more than keep pace with their efforts, a consummation devoutly wished for.



## SUGAR SYRUP.

The syrup is made to definite degrees upon a Balling or Brix scale. A 20° or 30° Balling syrup means the percentage of sugar in water: 20 or 30 pounds of sugar and 80 or 70 pounds of water in a 100-pound batch.

To make a syrup of the degrees usually employed, taking one gallon of water as a basis, the following amounts of sugar are added:

*Water—1 Gallon.*

| Density.<br>Degrees, Balling. | Quantity of Sugar. |         |
|-------------------------------|--------------------|---------|
|                               | Ounces.            | Pounds. |
| 5                             | 7.                 | .44     |
| 10                            | 14.8               | .92     |
| 15                            | 23.5               | 1.47    |
| 20                            | 30.8               | 1.92    |
| 25                            | 44.5               | 2.8     |
| 30                            | 57.1               | 3.57    |
| 35                            | 71.8               | 4.48    |
| 40                            | 88.8               | 5.55    |
| 45                            | 109.               | 6.81    |
| 50                            | 133.3              | 8.33    |
| 55                            | 163.9              | 10.24   |
| 60                            | 200.               | 12.5    |

The water and sugar should be heated to near the boiling point, thoroughly stirred to be certain that the sugar has been dissolved, then strained to remove the scum.

The syrup in the finished product will not be the same as the original on account of some of the sugar going into the fruit and some of the water coming out, but there is a ratio by which it is possible to determine fairly closely what degree was used. These data are in Bulletin No. 196, United States Bureau of Chemistry.

In all cases a Saccharometer should be used to accurately test the degrees of syrups.

## GRADES OF CALIFORNIA CANNED FRUITS.

Following are the grades of canned fruits recognized by California canners, most of whom make them the minimum, while several make a higher standard for the same grades:

**Apricots.**—*Extra 3's*—Eight to the pound and larger, ripe, firm and well colored, free from rust, scale and all imperfections; fruit uniform in size and texture, not over 24 pieces in each can, carefully packed, 28 ounces, including can.

*Extra 2½'s*—Same as 3's slightly smaller fruit, not over 24 pieces in each can, 25 ounces, including can.

*Extra Standard*—Ten to eight to the pound, ripe, firm, well colored, clean and uniform in size, not over 28 pieces in each can, 25 ounces, including can.

*Standard*—Twelve to ten to the pound, same quality as extra standard, fairly clean, uniform in size, not over 36 pieces to each can, 25 ounces, including can.

*Seconds*—Smaller than twelve to the pound, fairly firm and clean fruit, not good enough for standards, 25 ounces, including can.

*Water*—Same as seconds unless otherwise specified, 25 ounces, including can.

*Pie*—Soft and imperfect fruit.

**Peaches, Free and Cling.**—*Extra 3's*—Worked from  $2\frac{1}{2}$ -inch and up, to peel out not less than  $2\frac{3}{8}$  inches, ripe, firm fruit, nicely peeled and worked, uniform in size and texture, with careful work in canning, 8 to 12 pieces in each can, 28 ounces, including can.

*Extra Standard*—Worked from  $2\frac{3}{8}$ -inch to  $2\frac{1}{2}$ -inch peaches, to peel out not less than  $2\frac{1}{4}$  inch, good work in peeling and canning, ripe, firm fruit, uniform in size, 12 to 14 pieces in each can, 25 ounces, including can.

*Standard*— $2\frac{1}{4}$ -inch to  $2\frac{3}{8}$ -inch peaches, to peel out not less than  $2\frac{1}{8}$  inches, same quality and work as extra standard, 14 to 16 pieces to each can, 25 ounces, including can.  
worked, 25 ounces, including can.

*Seconds*—Fruit not large enough for standards, fairly firm and worked, 25 ounces, including can.

*Water*—Fruit not large enough for seconds, good-sized pieces, not necessarily halves, unless specified as seconds or standards in water when you use grade specified, 25 ounces, including can.

*Pie*—Peeled, soft and broken pieces; unpeeled, small and over-ripe fruit.

**Black Cherries.**—*Extra 3's*—Not less than 1 inch in diameter, cleaned free from blemishes of all kinds; care taken not to bruise in sorting and canning, fruit uniform in size and color, 28 ounces, including can.

*Extra 2½'s*—Same as extra 3's, slightly smaller, 25 ounces, including can.

*Extra Standard*— $\frac{7}{8}$ -inch to 1-inch diameter; must be sound, clean and free from blemishes; 25 ounces, including can.

*Standard*— $\frac{3}{4}$ -inch to  $\frac{7}{8}$ -inch diameter, sound, clean and fairly free from blemishes, 25 ounces, including can.

*Seconds*—Less than  $\frac{3}{4}$  inch in diameter, fairly clean and sound, 25 ounces, including can.

*Water*—Same as seconds, 25 ounces, including can.

*Pie*—All fruits not suitable for other grades.

**Bartlett Pears.**—*Extra 3's*—Worked from  $2\frac{5}{8}$  inch and up, pare and peel out not less than  $2\frac{1}{2}$  inches, evenly and nicely peeled so as to keep natural shape of pear, free from worms and well cored,



care taken in packing the cans, uniform size, fruit to be ripe and firm, 7 to 9 pieces in each can, 27 ounces, including can.

*Extra 2½'s*—Same as extra 3's, slightly smaller, 7 to 9 pieces in each can, 24 ounces, including can.

*Extra Standard*—2½'s, pears to peel out not less than 2¾ inches, evenly and nicely peeled to keep shape of pear, well cored, care taken in packing, uniform size, fruit to be ripe and firm, 9 to 10 pieces in each can, 24 ounces, including can.

*Seconds*—2¼-inch pears and less, ripe, fairly peeled and cored, 12 to 14 pieces in each can, 24 ounces, including can.

*Water*—Fruit not suitable for table grades and too good for pie.  
*Pie*—All soft, broken and inferior fruit.

**All other fruit**, as a rule, to be assorted in five grades. The largest and best to be used in packing the 3's and 2½ extras; 2½'s extra, slightly smaller than 3's, always to be ripe, firm, clean and perfectly free from blemishes, the greatest care taken in working and canning, and at all times uniform in size and texture.

The second size or next to the largest, to be used for the extra standard grade, to be ripe, firm, clean and free from blemishes, uniform in size and texture.

The third size to be packed in standards, to be ripe, firm and fairly clean and free from blemishes, uniform in each can.

The fourth size, to be used as seconds or water.

All inferior fruit, such as may be too soft, cracked or with other blemishes that make it unsuitable for the other grades, irrespective of size, will constitute the fifth grade and shall be used for pie.

## APPLES.

Apples is an article of much importance, and has in late years grown to be a large pack and in great popular demand. But as great as it is, there is a splendid opportunity to immensely increase the consumption of it in the canned shape. That it is popular with the masses goes without saying, but it is a fact that probably not 50 per cent. of the people of the United States know that they can purchase apples in cans. If all the housewives of the country knew that they could purchase apples ready for use, without the waste of peeling, cores, specks, etc., as in the green fruit, and at an actual saving, the consumption and, consequently, the demand would greatly increase.

Use "picked" apples and do not mix the varieties.

Firm, tart varieties of apples are best for canning. Peel, core and cut out all decayed and discolored portions; halve or quarter, according to size of fruit; drop immediately in a 2 per cent. salt bath; this prevents the brown discoloration of the surface. Remove from the bath, wash thoroughly in running cold water, place in cans, fill with boiling water, seal, and process No. 3 cans 8 minutes at 212 degrees, No. 10 cans 10 minutes at 212 degrees.

### APPLES, WHOLE, FOR DUMPLINGS.

Select tart apples, rather under-ripe, of desired size; peel and core; wash thoroughly in running cold water; blanch 1 minute in a bath containing  $\frac{1}{2}$  lb. salt to 12 $\frac{1}{2}$  gallons water; pack in cans, add hot water, seal and process No. 3 cans 8 minutes at 212 degrees, No. 10 cans 15 minutes at 212 degrees.

### APRICOTS.

Apricots are packed almost exclusively in California, and generally in No. 2 $\frac{1}{2}$  cans. They are carefully sorted as to size; generally not peeled, but are wiped, either by hand or machine; halved and pitted. Syrup slightly lighter than for peaches is used, put on hot, the cans exhausted 3 minutes, sealed and processed for 25 minutes at 212 degrees.

### BLACKBERRIES.

This fruit is usually packed in No. 2 or No. 10 cans, is wholesome and in good repute in every section of the country; and if it is packed in good style, demand could easily be greatly increased. The preserved article meets with quite a good demand, and, as it could be canned so as to sell at a lower price than the preserved in glass, it is reasonable to suppose a large trade could be worked up on them; but this will all depend upon the quality of the goods and the perseverance with which this quality is maintained.

We would advocate a rather better quality than usual, suggesting that instead of being put up in water they be packed in not less than 20 degrees cane sugar syrup. In other words, to make them suitable for home consumption as they come from the can, without further treatment, and the cans must be full. As the No. 10's are for re-cooking by bakers or hotel trade, they are packed in water.

Stem and clean; if any sand or grit, remove by washing, but do not wash unless absolutely necessary; place in cans, fill with hot syrup, seal and process.

No. 2 cans, 8 minutes at 212 degrees.

The inferior fruit may be packed in No. 10 cans, as pie stock, following the above directions, filling with hot water instead of syrup. No. 10 cans, 22 minutes at 212 degrees.

### EXTRA FANCY OR PRESERVED.

Select fine, cultivated fruit of moderate size and not over-ripe.

Place 3 pounds of fruit and 3 pounds of granulated sugar in suitable vessels and allow to remain, giving them an occasional stirring until the juice of the fruit dissolves the sugar. Then place



in cans, exhaust 5 minutes, seal and process No. 2 cans 8 minutes at 212 degrees.

This style of goods will compete successfully with the preserved in glass, and, if honesty counts for anything in this world, should be profitable to the packer.

The juice which drains from the packing table may be utilized for jelly, fruit syrup or for wine or cordial, provided cleanliness and neatness are observed in handling the pack.

### BLUEBERRIES.

Clean from sticks, stems and green fruit, place in cans and fill with boiling water, or fill with cold water and exhaust to 160 degrees, seal and process.

No. 10 cans, 25 minutes at 212 degrees.

### RED CHERRIES.

Stem the cherries, pick out all leaves, place in cans, fill with hot water, seal and process, for pie stock:

No. 2 cans, 8 minutes at 212 degrees; No. 10 cans, 22 minutes at 212 degrees.

When unpitted canned cherries are carried over from season to season they are apt to develop without apparent reason what may be termed "spring swelling" at a certain period of the year.

When this is detected by the springing of the cans, vent and reprocess No. 2 cans 8 minutes at 212 degrees and No. 10 cans 15 minutes at 212 degrees.

### RED CHERRIES, PITTED.

Stem the cherries, remove all leaves, pit by any appropriate method, place in cans, fill with hot water or syrup of the desired density. Seal and process No. 2 cans 12 minutes at 212 degrees, No. 10 cans 30 minutes at 212 degrees.

Most hand and power seeders will tear and mutilate cherries to a greater or less extent, and, when the price obtained for the finished goods will allow it, it is best to seed by hand. This is easily accomplished by first stemming the cherry, then force the seed out through the stem opening by gentle pressure of the thumb and forefinger on the pointed side of the seed. When it is desired to have the fruit retain its shape, the seed may be ejected through the stem hole by employing for the purpose a small pitting spoon set in a handle. By proper manipulation the cherry will be but slightly torn.

Cherries to be packed in cordial must be seeded in this manner.

Where a comparatively large quantity of cherries are to be pitted, though not enough to warrant the purchase of a power machine, it is advised that a series of small rotary hand seeders be pro-

vided, with a grooved wheel in place of the crank, and fastened securely to a substantial table carrying a shaft, either above or beneath, fitted with grooved pulleys for round driving belts to connect with the seeders. This is a fairly rapid and economical apparatus and will give satisfactory results where the tearing of the fruit is not too objectionable.

#### WHITE WAX CHERRIES.

Handle and process the same as red cherries, rejecting all discolored and bruised fruit.

#### CRANBERRIES.

Pick out the defective berries, wash in cold water, place in cans, fill with hot water; seal and process No. 10 cans 20 minutes at 212 degrees.

#### CURRANTS.

This fruit, like gooseberries, is one of the limited articles of packing. It is generally used in the making of preserves, and consequently there is not much demand for the canned article.

#### CURRANTS, RED.

Red currants are packed very much like gooseberries.

Stem and clean, place in cans and fill with hot water or syrup, seal and process.

No. 2 cans, 10 minutes at 212 degrees; No. 10 cans, 25 minutes at 212 degrees.

#### FIGS—No. 1.

Clean the figs, wash in cold water, blanch five minutes in boiling water, place in cans, fill with boiling water or syrup of desired density, seal and process at 212 degrees, No. 3 cans 30 minutes, No. 10 cans 70 minutes.

#### FIGS—No. 2.

Dry clean the figs and soak 12 hours in 8 per. cent. brine (8 pounds of salt to 12½ gallons water), remove and wash in cold water, place in cans, then proceed same as previous process.

#### GOOSEBERRIES.

This article is mainly, if not entirely, used by piemakers. It is put up by packers generally with this idea in view, and, while these pie foundries create a considerable demand, to which must be added a small demand for home consumption, still a great pack of it could not be disposed of.



## STANDARD.

Run the fruit through a dried fruit cleaner, or through a fan-mill fitted with a medium sieve; wash in cold water, place in cans, fill with hot water, seal and process.

No. 2 cans, 14 minutes at 212 degrees.

No. 10 cans, 40 minutes at 212 degrees.

## GOOSEBERRIES, RIPE.

Wash the fruit to remove all chaff and stems, place in cans, fill with hot water, seal and process.

No. 2 cans, 12 minutes at 212 degrees.

No. 10 cans, 35 minutes at 212 degrees.

## GRAPES.

Grade, steam and place in cans, fill with hot syrup, seal and process No. 2½ cans 15 minutes at 212 degrees.

## MOLASSES.

Sorghum, cane molasses or any mixture of them, either with or without glucose, should be given a short sterilization in the can after sealing, but the goods must be placed in the can at a temperature of not less than 160 degrees and must be not less than that when cans are sealed. In order to be sure of this, and for sanitary reasons, it is best to wash the cans with boiling water, or subject to a steam bath, before filling. The slip cover has proven satisfactory with this class of goods. Some packers run the molasses or mixture into cans above 160 degrees F. and seal at that temperature with good success. Sealed cans, if processed, should be given: No. 3, 8 minutes at 212 degrees; No. 10, 16 minutes at 212 degrees F.

## PEACHES.

To handle peaches successfully requires a considerable force of hands and much capital, for while there are machines to do the peeling, the general custom is to secure a large number of hands, who peel the fruit and remove the stones. The peelers are arranged along tables, much in the same manner as is done for tomatoes, but constant care and attention are required in order that the peeling be done properly. To turn out fine fruit, the peeling must be smooth and not too deep, and then, if the fruit is not handled rapidly, it will turn brown, taking on a rusty appearance. It is claimed this discoloration may be removed by blanching the fruit a few minutes in boiling water, and, if the process is done properly, all appearance of it will have disappeared in the finished article.

The various degrees of syrup are given in another part of this Complete Course, and should be referred to when required.

### PEACHES, STANDARD.

Use nearly ripe, unbruised fruit, cut in halves, remove seed, employing a pitting spoon if peaches are soft; pare smoothly and evenly with a sharp, thin-bladed knife; place in cans, fill with hot syrup; seal and process:

No. 1 cans, exhaust  $1\frac{1}{2}$  minutes and process 15 minutes at 212 degrees.

No.  $2\frac{1}{2}$  cans, exhaust 3 minutes, process 20 minutes at 212 degrees.

No. 3 cans, exhaust 3 minutes, process 20 minutes at 212 degrees.

No. 10 cans, exhaust 5 minutes, process 35 minutes at 212 degrees.

The above is for standard grade. Extras or seconds are packed in the same way, the difference being in the quality of fruit and syrup used, and a slight variation in the time.

### PIE PEACHES.

Use inferior fruit, not suitable for standard or the better grades; wash in cold water, separate the hard and the soft fruit; cut in halves, remove seed, pack in cans, fill with hot water, seal and process No. 10 cans.

Hard fruit, exhaust 5 minutes and process 35 minutes at 212 degrees.

Soft fruit, exhaust 4 minutes and process 30 minutes at 212 degrees.

### PEACHES, DRY PACKED OR SLICED.

Select yellow peaches, rather underripe, halve, remove seed, pare, cut in small sections suitable for table use; mix with 20 per cent. of finely granulated rock candy, place in No. 1 cans, shaking down the mixture and settling as tightly as possible without mashing, exhaust in steam box, and seal: No. 1 cans, 8 minutes; No. 2 cans, 10 minutes. Process: No. 1 cans, 15 minutes at 212 degrees; No.  $2\frac{1}{2}$  cans, 20 minutes at 212 degrees.

### PEACHES, EXTRA FANCY, WHOLE.

Select large, perfect peaches, just slightly underripe, remove the seed with a pitting spoon, dip momentarily in boiling hot water; rub or pull off the skin; pack carefully in cans, stem end up; fill with 42 degrees boiling hot syrup; seal and process:



No. 2 cans, 15 minutes at 212 degrees.

No. 3 cans, 20 minutes at 212 degrees.

If desired, the syrup may be flavored by a portion of the seed. For a 50-gallon batch, take  $\frac{1}{2}$  lb. of seed, crush with a hammer, tie in a cheesecloth bag and cook with the syrup.

#### PEARS (KIEFER OR OTHER HARD VARIETIES).

Pare and cut in quarters, remove core and seed, place in cans, fill with hot water or light syrup, seal and process No. 2 cans 20 minutes at 212 degrees; No. 3 cans, 25 minutes at 212 degrees; No. 10 cans, 35 minutes at 212 degrees.

#### PEARS (BARTLETTS OR OTHER SOFT VARIETIES).

Peel and cut in halves; remove seed and core if desired; throw in bath containing 2 ounces salt in 6 gallons water; remove from bath and wash in cold water; blanch one minute in boiling water, place in cans, fill with water or syrup; seal and process for same time as hard pears in quarters.

#### PEARS, FOR WEISBADEN PROCESS.

Select slightly underripe, fine large Bartletts, peel smoothly and carefully, scrape the green skin from stem, halve the fruit, leaving the entire stem on one-half of the pear; throw immediately in salt water bath; when a sufficient quantity has been prepared remove from bath, wash in cold water, place in cans; fill with hot, heavy syrup, seal and process No. 2 cans 12 minutes at 212 degrees; No. 3 cans 15 minutes at 212 degrees.

#### PINEAPPLE.

This is an article that is gaining in popularity every year. It is, perhaps, the steadiest article in price on the market, but because of the expense in handling, the care required, and the difficulty of the average packer securing a supply, it cannot be considered as an article of general packing. Some years ago its packing was almost entirely confined to Baltimore, though considerable was packed in the West India Islands. Now it is mainly packed in the Hawaiian Islands.

#### HAWAIIAN PINEAPPLE.

In the past years the Hawaiian Islands have come to the front as the producers of the finest pineapple in cans. This pineapple is not white in color, but tinted yellow, is tender and full of the real pineapple flavor, a condition that is brought about through the fact

that the fruit is allowed to ripen on the plant, and is then canned. In addition the packers have well advertised their goods, and now have the market.

The introduction of machinery into the operation of packing pineapples, as in every other particle of canned foods, has greatly facilitated its handling. In fact, it is practically impossible to profitably handle it without this machinery, and this must be taken into consideration.

Pineapple is packed in almost every style of tin cans, from the small No. 1 lunch size to the No. 10; and the variety of styles in which it is presented vary as greatly as the sizes of the cans.

When pineapples are received, assort and carefully separate the ripe fruit, ripe specks, green and green specks. Handle as gently as possible to avoid bruising, as all bruised places will speck in a very short time. Work up the ripe specked fruit first, following with the ripe fruit next, unless the quantity of specks is such that the ripe fruit is likely to speck before this can be accomplished. After handling these, use the green specks, then the green ones as they ripen. If space allows, store the green pines on floor, butt-end down in single layer, so that as they age the ripe ones may be removed without disturbing the unripe fruit. When space will not allow separating them in this manner, do not pile more than eighteen inches deep; sort the pile over every day and remove all ripe and specked ones.

When peeling by hand, first square the butt with a sharp knife and twist out top; place pine butt down on a table and with a drawing sweep of the knife slice off the outside skin, making cut deep enough to reach about half way to bottom of the eye, then trim off the circle of skin left on top and bottom. This first peeling is of little use and may go to the refuse heap.

Then make a second peeling in the same manner, cutting deep enough to remove the eyes on the pine, in which case it may be removed by the pincer-like implements intended for this purpose.

When peeling with a rotary machine, arrange back of the knife shaft a double spout with a valve or shutter at the top to be worked with a foot treadle, arranged in such a manner that the first peelings may be ejected through one spout and the second peelings through the other. This will save the time and trouble of changing the pines from one machine to the other in separating the first and second peelings. The juice from the first peelings may be expressed and used to replace water in making syrup for extra and fancy goods. The second peelings are used for seconds, grated or pie grade.



## SETTING UP MACHINES.

Referring to plan of power factory, place two peeling machines in 280 and 92—three sizing machines (one each  $2\frac{3}{4}$  inches, 3 inches and  $3\frac{1}{8}$  inches) in 269—81—93; three coring machines in 270—82—94; one slicing machine in 283; one corecutter in 295, and two saw grinders in 285—97. Packing tables to occupy space bounded by 194, 202, 254, 262. Arrange suitable shoots so that pines may be readily transferred from one line of machine to the other.

Reserve the middle portion of the ripest, largest and soundest fruit for extra sliced, the medium and small pines and the end slices of the larger pines for standard and the entire slices of the sound portion of the specked for seconds. The trimmings left by the sizing machines are the choicest part of the pines and, depending on the amount of sugar used, may be graded as fancy or extra standard graded. The imperfect top and bottom slices of small pines when graded grade as seconds. The second peeling and small pieces of the sound portion of specked fruits are packed in water and classed as pie fruit. Cut the cores in  $\frac{3}{4}$  inches to 1 inch lengths and pack in water for confectioners' use.

After paring, sizing and coring, run through the slicer, which may be adjusted as your trade demands to cut in thickness from  $\frac{1}{8}$  inch to  $\frac{1}{2}$  inch for confectioners' use for crystallizing, etc. *Note:* Thick slices for confectioners should not be cored; if cored when subjected to the action of concentrated syrups used in crystallizing the end of the fibres in core hole will swell and make the finished slice present an unsightly appearance.

Place the slices in a perforated copper bucket or willow basket, and plunge momentarily in boiling water, then in cold water; turn out on packing table, assort according to diameter of slices and pack in cans, either counting the slices or weighing out the required amount for each can. Fill the cans with hot water or syrup of the desired density, seal and process:

No.  $\frac{1}{2}$  cans, 14 minutes at 212 degrees.

No. 1 cans, 18 minutes at 212 degrees.

No. 2 cans, 20 minutes at 212 degrees.

No. 3 cans, 25 minutes at 212 degrees.

No. 10 cans, 40 minutes at 212 degrees.

## EXTRA GRATED.

Extra grated pineapple must be eyeless and coreless. Standard grated must contain but few specks.

Place the grated pine suitable for these grades in a jacketed copper kettle, add the desired amount of sugar, bring to a boil and stir until sugar is dissolved; fill in cans hot.

## PIES.

For pie grade, place in kettle, add sufficient water to make it handle readily, bring to a boil; fill in cans hot.

Seal and process same time as slices, though No. 10s packed in water, either sliced or grated, may be processed 5 minutes less than syruped goods.

## PINEAPPLES, DRY-PACKED.

Pare, remove all eyes and core; cut in dice  $\frac{3}{4}$  inch square; roll in granulated rock candy; pack closely in cans; fill all crevices with granulated sugar, exhaust No. 2 cans 10 minutes in steam box, seal and process 20 minutes at 212 degrees. Slices may be packed same way.

## WHOLE PINEAPPLE.

Pare, core and remove all eyes from fruit which will fit cans without passing through sizing machine; place in sanitary cans, fill with hot 35-degree syrup, seal and process:

No. 2 cans, 25 minutes at 212 degrees.

No. 3 cans, 35 minutes at 212 degrees.

All machines used in handling pineapples should be washed up during the noon shutdown; at night, after washing up, all the iron surfaces coming in contact with the pines should receive a thin coating of petrolatum or some similar substance.

## PLUMS.

Green gage, yellow egg and Lombard are generally used, though other varieties may be. Wash, pack in cans with desired degree of hot syrup, exhaust and process; No. 2½ cans, 14 minutes at 212 degrees; No. 3 cans, 16 minutes at 212 degrees; No. 10 cans, 30 minutes at 212 degrees, for plums with small seeds. Those with large seeds must be given five minutes longer on smaller sizes of cans, and 10 minutes longer on No. 10s.

## QUINCES.

Pare, core and cut in quarters or eights, drop in salt bath ( $\frac{1}{2}$  lb. salt to 5 gallons water), remove and wash in cold water, place in cans, fill with hot syrup or water, seal and process No. 2 cans 15 minutes at 212 degrees.

When quinces are intended for use only in preserves or jams, pare, core and cut in small pieces or cubes, throw in salt bath as above, remove and place in jacketed kettle, cover with cold water and bring, very slowly, just to a boil; then drain off water, place in



No. 10 cans; fill with hot water, seal and process 30 minutes at 212 degrees.

### RASPBERRIES.

This berry is usually packed in No. 2 cans, though a considerable quantity is put up in No. 10 cans for bakers' purposes. In the red variety, especially, this fruit is so expensive in its fresh state that the packing of it, other than as preserved goods to sell at high prices, is almost prohibitive, and the amount packed is usually quite small. For this reason many consider red raspberries in the light of a stock suitable for preserving in glass, etc., but beyond the canners' reach.

The black variety may be obtained at comparatively low prices and in good quantity, and is, therefore, better adapted to the canner's use. In sections of the country where this crop is abundant and oftentimes a glut on the market, packers would find it to their advantage to get the fruit into No. 10 cans as pie stock, for which there is nearly always a good demand. Then, again, this class of fruit, put up in water or light syrup, may be worked up during the winter months into preserves, jams, etc., or sold to those manufacturers who work it up.

### STANDARD.

Pick and remove all leaves and refuse; all grit must be removed, but do not wash if avoidable; place in cans, fill with hot syrup of the desired degree; seal and process:

No. 2 cans, 8 minutes at 212 degrees.

No. 10 cans, 22 minutes at 212 degrees.

Raspberries may be processed at a low temperature, treating them the same as strawberries.

### EXTRA FANCY OR PRESERVED.

Select the finest fruit, slightly underripe; pick carefully and free from all caps and refuse; place in cans and fill with hot syrup of 42 degrees. Seal and process No. 2 cans, 8 minutes at 212 degrees.

A heavy sugar syrup has the effect of greatly shrinking and hardening raspberries and a better eating article can be produced by cooking the berries in a jacketed kettle with an equal weight of sugar to preserve consistency; then can, seal and process as above.

### RASPBERRIES IN WATER.

The culls, soft and inferior fruit may be packed in No. 10 cans in water for preservers' and bakers' uses.

Clean the fruit, place in jacketed kettle, add enough water, about 15 per cent., to make them handle readily; bring to a boil; fill in cans. Seal and process 23 minutes at 212 degrees.

### STRAWBERRIES.

Cap the berries, separate into two classes, reserving the largest and most perfect fruit for standard and extras, the balance for seconds. Wash in cold water to remove sand in a tub fitted with a sieve, or perforated metal diaphragm, 6 inches above the bottom to retain berries when water is drawn off. Place in cans, when the seconds may be again sorted to remove the very soft, imperfect and torn berries, which are fit only for preservers' uses in making jelly and cheap preserves. Fill the cans with hot water or hot syrup of the desired density. Seal and process:

No. 1 cans, 8 minutes at 212 degrees.

No. 2 cans, 10 minutes at 212 degrees.

No. 10 cans, 22 minutes at 212 degrees.

Under no circumstances should the syrup be thickened with glucose. This combination will almost invariably generate a disagreeable odor and taste, and will be rendered unfit for sale and for consumption. The color may be conserved by processing at a low temperature—180 degrees F.—and by the use of inside enamelled or lacquered cans.

Sterilization at this temperature may be accomplished in an open kettle, if sufficient care is exercised. Fill the cans with selected fruit, then with syrup at a temperature of not more than 200 degrees; seal; place in kettle and fill with cold or cool water; turn on steam and bring very slowly to 180 degrees; then cut steam and maintain between 175 degrees and 180 degrees; 60 minutes for No. 1 cans, 75 minutes for No. 2 cans; then remove from bath and cool. Sterilization at this temperature may be done in retorts connected with a condenser and pump, the same as used with vacuum pans; from time to time, as the water evaporates, supply sufficient of like temperature to keep the cans entirely covered.

### PRESERVED (CANNED) STRAWBERRIES.

To make the finest quality of canned strawberries, such as are branded "Preserves," pick sound, ripe berries, wash, add an equal weight of sugar to the fruit, place in crocks or other suitable containers in small lots of not more than six pounds each; stir occasionally until the juice of the fruit dissolves the sugar; then place in cans. Exhaust No. 1 cans for four minutes, seal and process three minutes at 240 degrees, or eight minutes at 212 degrees; or better, exhaust 10 minutes at 180 degrees and sterilize 60 minutes at 180 degrees.



# MEATS

Packers of fruits and vegetables, wishing to establish a winter pack, and who are so situated as to be able to procure supplies of poultry, game, etc., at reasonable prices, may be able to include these items in their line.

Of course, it is understood that the small canner cannot compete with the great meat packing establishments in heavy lines, such as corned beef, but there is a certain demand for high-grade specialties which he may supply at a profit.

All raw stock must be in good condition when packed; no amount of manipulation or processing will make bad meat good; high spicing may cover the putrid odor and taste, but will not insure the consumer against sickness or possible death, nor prevent prosecution under the food law.

As far as possible, pack meats in cans while hot, and process without exhausting. If packed cold, cap, tip and give one-half the process, then vent cans, re-seal, and give remainder of process. Process temperature for all kinds of flesh is 250 degrees F.

The preliminary cooking in water may be done either in jacketed kettles, or tanks containing closed copper coils. Provide and use, unless otherwise directed, tight-fitting copper coils. Do not throw meat loose in vessel, but pack in a covered wire crate made of tinned iron, or, if not too expensive, of perforated copper.

Utilize the surplus water in which meats are boiled, for soups.

## MEAT JELLY.

Place 100 lbs. calves feet with 12½ gals. water in kettle, and add 2 lbs. sliced onions, 2 lbs. sliced carrots, ¼ lb. each of whole black pepper, celery seed and green pot herbs contained in a muslin bag; turn on steam, bring slowly to a boil and simmer eight hours, adding water to make up loss by evaporation; draw off liquor and strain; when it jells, skim grease from top and return to kettle, adding 1 pint of lemon juice or 1 oz. tartaric acid; turn on steam and heat to 180 degrees. Mix ½ gal. white of egg free from yolk an equal bulk of water, crush the egg-shells and add thereto; stir this thoroughly in the melted jelly, bring to a boil and strain through a flannel bag previously wet with water. Instead of eggs, blood, or the isinglass solution given under soups, may be used.

## BOILED BEEF.

Select moderately lean beef, cut in can size pieces, allowing 25 per cent. for loss in weight; place in crate and plunge in boiling water containing 3 lbs. salt to each 12½ gals. Boil 2½ to 3 hours,

hoist out crate and pack meat in cans; fill the cans with jelly made by boiling down 12 gals. of the water in which the meat was cooked to 6 gals. and dissolving therein 1 lb. gelatin, previously soaked in cold water for one hour, and adding 2 oz. ground white pepper. Solder on tops, tip and process at 250 degrees, 1 lb. can 45 minutes, 2 lb. cans 55 minutes, 3 lb. cans 65 minutes, and 5 lb. cans 85 minutes.

### CORNERED BEEF.

Cut the corned beef to can hole size, place in kettle and cover with cold water; bring slowly to a boil and cook gently one hour; hoist crate from kettle; place beef in cans, packing and ramming solidly; cap, tip, and process at 250 degrees, 1 lb. cans 40 minutes, 2 lb. cans 45 minutes, 3 lb. cans 50 minutes, 4 lb. cans 55 minutes, 5 lb. cans 60 minutes, 6 lb. cans 65 minutes, 7 lb. cans 70 minutes, 14 lb. cans 90 minutes.

### ROAST BEEF.

Cut the beef in can size pieces, allowing 30 per cent. for shrinkage; wrap the pieces with string and place on end in roasting pan; for a 50-lb. batch, sprinkle on the beef one oz. ground black pepper, and place in the pan 2 quarts water in which has been dissolved  $\frac{1}{2}$  lb. salt; place pan in a hot oven and cook 30 minutes for 2 lb pieces, 40 minutes for 3 lbs.; turn the meat when half the time has expired, and baste to prevent burning; when done, take out the meat and make gravy from a quart of the pan grease and one pint of flour, and mix smoothly; then add 2 gals. boiling water, and stir continually until it boils; add  $\frac{1}{2}$  lb. salt, 1 oz. ground black pepper, and sufficient caramel to produce a rich brown color. Place the roasted meat in cans, fill with the gravy, solder on lid, tip and process at 250 degrees 1 lb. cans 40 minutes, 2 lb. cans 50 minutes, and 3 lb. cans 60 minutes.

### BEEF CANNELON.

- 100 lbs. Beef.
- 4 doz. Eggs.
- $\frac{1}{2}$  lb. Green Parsley, chopped fine.
- 10 lbs. Bread Crumbs.
- $\frac{1}{4}$  lb. Powdered Tartaric Acid.
- $2\frac{1}{2}$  lbs. Salt.
- 2 oz. Ground Black Pepper.

Trimmings and odd pieces of lean beef are used; cut in small pieces and plunge in a boiling solution of salt 3 lbs., water  $12\frac{1}{2}$  gals., cook until moderately well done, then chop fine. Dissolve the acid in a pint of water, separate and beat the eggs, and mix all the ingredients together; pack tightly in 1 lb. flat cans, cap, tip and process 55 minutes at 250 degrees.



## PRESSED BEEF.

- 100 lbs. Beef.
- 2 lbs. Salt.
- $\frac{1}{2}$  oz. Ground Cloves.
- $\frac{1}{2}$  oz. Ground Mace.
- 1 oz. Ground Cinnamon.
- 1 oz. Ground Allspice.
- 4 oz. Black Pepper.
- $\frac{1}{2}$  oz. Cayenne Pepper.
- $1\frac{1}{2}$  pints Vinegar.

Place the beef in kettle, cover with cold water, bring to a boil and cook until well done; remove all bones, cut in small pieces, mix with salt and spices, and pack in 1 lb. flat cans.

Reduce the liquor in which the meat was cooked to  $2\frac{1}{2}$  gallons, add the vinegar and pour over meat in cans; tip and process 45 minutes at 250 degrees.

## BEEF STEW.

- 100 pounds Beef, cut in small pieces.
- 15 pounds Sliced Onions.
- 200 pounds Potatoes, cubed or cut in small pieces.
- $37\frac{1}{2}$  gallons Water.
- 2 pounds Soup Herbs.
- 1 pound Parsley.
- 4 pounds Salt.
- 1 pound ordinary Black Pepper.
- 10 pounds Flour.

Place the beef in kettle and cover with  $32\frac{1}{2}$  gallons of the water, turn on steam and bring slowly to a boil; a few minutes after boil commences the scum of the meat will rise to the top; turn off steam and skim this off; tie the soup herbs in a bag and throw in, add the onions, bring to a boil, and simmer three hours; then add the potatoes and salt, and cook ten minutes after it boils; then add the flour mixed with 5 gallons water; bring to a full boil and shut off steam; then add the pepper and the parsley very finely chopped. Pack in 3-pound cans; cap, tip and process 60 minutes at 250 degrees.

## ROAST MUTTON.

Handle and process same as Roast Beef, but fill cans with melted meat jelly, to which has been added a little of the pan grease.

## CURRIED MUTTON.

- 100 pounds Boiled Mutton, finely chopped.
- 50 pounds Rice.
- 7 pounds Butter.
- 5 pounds Flour.
- 2½ pounds Curry Powder.
- 3 pounds Salt.
- 6½ gallons Boiling Water.

Wash the rice and drop slowly in 40 gallons boiling water ; cook 35 minutes and drain water off. Place butter in kettle and melt ; mix the flour with butter ; add 6½ gallons water and stir constantly until it boils ; then turn off steam and mix in all the other ingredients, including the rice. Place while hot in 3-pound cans ; cap, tip and process 70 minutes at 250 degrees.

## IRISH STEW.

Make and process same as Beef Stew, substituting 200 pounds mutton for the 100 pounds beef.

## ROAST VEAL.

Handle and process same as beef.

## VEAL LOAF.

- 70 pounds Boiled Veal, boned.
- 10 pounds Boiled Ham.
- 20 pounds Bread Crumbs.
- ½ pound Salt.
- ½ pint Onion Juice.
- 6 dozen Eggs.
- ¼ pound ordinary Black Pepper.
- 2 ounces ordinary Sage.
- 3 ounces ordinary Cloves.
- 2 ounces ordinary Allspice.

Chop the veal and ham very fine ; beat the eggs, and add the onion juice ; then mix all the ingredients together. Press in moulds of same shape and size as cans ; turn out, and brush with new milk ; lay in baking pan and place in oven to brown ; when colored, place in cans ; solder lid, tip, and process 1-pound cans 55 minutes at 250 degrees.

## JELLIED VEAL.

- 100 pounds Knuckle of Veal.
- 2½ pounds Onions.
- 2 ounces Mace, whole.



2 ounces Cloves, whole.  
 1 ounce Bay Leaves.  
 4 ounces Whole Black Pepper.  
 2 pounds Salt.  
 1 quart Vinegar.  
 1 pint Worcestershire Sauce.

Cut the veal in small pieces, place in kettle, and cover with cold water; bring to a boil, and simmer one hour; then add the onion and allspice enclosed in a bag, and simmer one hour longer; take out the meat, remove the bones and pack in cans; add the vinegar and sauce to the liquor; strain and pour over meat in cans; cap, tip, and process in 1-pound cans 40 minutes at 250 degrees, and 2-pound cans 55 minutes at 250 degrees.

### ROAST VENISON.

Handle and process same as beef, adding one ounce butter for each pound in roasting pan; make gravy same way, but replace one quart of the water with sherry wine.

### TONGUE, BEEF'S.

Soak salted or smoked tongue in cold water 12 hours; place in kettle and cover well with cold water; bring to a boil and simmer two or three hours, according to size; take from kettle and remove skin, commencing at tip and stripping back to root. Roll it and place in can; fill can with veal stock. Solder on lid; cap, tip and process small tongues 60 minutes at 250 degrees; medium tongues 90 minutes at 250 degrees; large tongues, 120 minutes at 250 degrees.

### TONGUE, PIG'S.

Soak salted tongues in cold water for 12 hours; place in kettle, cover with cold water; bring to a boil and simmer two hours; take from kettle and remove skin; pack in flat cans and fill with veal stock; solder on lids and tip; process 1-pound cans 60 minutes at 250 degrees; 2-pound cans 90 minutes at 250 degrees.

### TONGUE, SHEEP'S.

Handle and process same as pig's tongues.

### POTTED BEEF.

85 pounds Beef.  
 20 pounds Salt Pork.  
 3 pounds Salt.  
 1½ pounds Mixed Spice.

Plunge the beef in salted, boiling water, and cook until very tender; cover the pork with cold water, bring to a boil, and cook  $2\frac{1}{2}$  hours; remove all bones from the beef and skin the pork; grind the mixed beef and pork to a smooth paste, thoroughly incorporate the salt and mixed spices; place in cans; cap, tip and process  $\frac{1}{4}$ -pound cans 40 minutes at 250 degrees;  $\frac{1}{2}$ -pound cans 45 minutes at 250 degrees; 1-pound cans 50 minutes at 250 degrees.

Mixed spices for above: 2 pounds ground white pepper,  $\frac{1}{4}$  pound cayenne pepper, 1 ounce powdered nutmegs, 4 ounces powdered cinnamon seed, 2 ounces summer savory, 1 ounce powdered sweet marjoram and 2 ounces powdered thyme.

### POTTED HAM.

Place 10 pounds of ham or shoulders in kettle and cover well with cold water; add  $\frac{1}{4}$  pound mace,  $\frac{1}{2}$  pound cloves and 1 ounce bay leaves; bring very slowly to a boil and simmer 4 hours; when done, take out and remove the skin and bone, and grind to a paste; add  $\frac{3}{4}$  pound ground white pepper, 4 ounces ground cayenne pepper, 2 ounces powdered sage and salt, if necessary; place in cans; cap, tip and process same as beef. If the hams are very fat, use a portion of them for beef and tongue in place of pork.

### POTTED TONGUE.

75 pounds Salted Tongue.  
 25 pounds Salted Pork.  
 3 pounds Salt.  
 $\frac{1}{2}$  pound Ground Black Pepper.  
 $1\frac{1}{2}$  ounces Powdered Cloves.  
 $1\frac{1}{2}$  ounces Powdered Allspice.  
 1 ounce Coriander Seed.  
 $\frac{1}{2}$  ounce Bay Leaves.  
 1 pint Onion Juice.

Soak tongues 12 hours in cold water; place in kettle, cover with cold water; bring to a boil and simmer 3 to 4 hours, according to size; when done, take out remove skin; cook the pork and skin; grind very fine and mix with the other ingredients; place in cans, cap, tip and process same as beef.

### POTTED CHICKEN.

90 pounds Chicken.  
 10 pounds Salt Pork.  
 5 pounds Onions, sliced.  
 4 pounds Salt.  
 1 pound Parsley.



$\frac{1}{2}$  pound Ground White Pepper.  
 $\frac{1}{4}$  pound Whole Cloves.  
 2 ounces Mace.  
 1 ounce Bay Leaves.

Cook and skin the pork, same as for beef; draw and clean the chickens; place in kettle with 2 pounds of the salt, the onions, parsley, cloves, mace and bay leaves; cover with cold water; bring to a boil; simmer until tender; take from kettle and remove skin and bone; grind to a fine paste; mix the remainder of the salt and the pepper with it; place in cans; cap, tip and process same as beef.

Use the liquor in which the chickens are cooked for chicken soup, or concentrate it to one-half its bulk; place in one-gallon cans; cap, tip and process 55 minutes at 250 degrees, and sell as concentrated chicken soup.

#### POTTED TURKEY, OTHER POULTRY AND GAME.

Make and process same as chicken.

#### ROASTED CHICKEN.

Draw, singe, clean and truss the chickens. Clean the giblets, place in kettle, cover with cold water, bring to a boil and simmer while chickens are roasting.

For each chicken put two thin slices of bacon and place chicken thereon; if to be canned, in halves, split lengthwise, or in quarters (breasts), cut before roasting.

Cover the bottom of pans with water in which salt has been dissolved (1 lb. for 100 pounds of chicken), and put pans in oven and cook one to one and a half hours; when done, take chickens and bacon out of pan, and make sauce.

To each pint of grease add 1 lb. butter and 1 pint of flour, mix smoothly, and add 2 gallons of water in which giblets were cooked, put on fire and stir constantly until it boils; chop the giblets fine and mix them in the gravy with  $\frac{3}{4}$  of a lb. of salt,  $1\frac{1}{2}$  oz. ground white pepper and enough caramel to make a brown color.

Place chicken in can and fill can one-third full of the sauce, solder on lid, tip and process at 250 degrees,  $\frac{1}{4}$  chicken size, 55 minutes;  $\frac{1}{2}$  chicken size, 65 minutes; whole chicken sizes, 80 minutes.

#### STEWED CHICKEN.

Draw and clean the chickens; cut each one in eleven pieces; place in kettle and nearly cover with boiling water; bring to a boil and simmer until tender; remove from kettle; skin and carefully bone; fill in cans and cover with the following sauce:

To each two gallons of the liquor in which chickens were boiled, add one pint of flour, mixed with a little cold water; stir in and bring to a boil; add  $1\frac{1}{2}$  ounces of ground white pepper and  $\frac{3}{4}$  pounds of salt. Cap, tip and process at 250 degrees, 1 lb. cans, 55 minutes; 2 lb. cans, 65 minutes.

Richer sauce may be made by using a portion of cream and yolk of eggs. If it is desired, the chicken may be packed without removing bones, in which case allow a process of 10 minutes more.

### CHICKEN IN JELLY.

- 100 pounds Chicken.
- 3 pounds Onions, chopped.
- 1 ounce Bay Leaves.
- 1 ounce Whole Mace.
- 2 ounces Whole Cloves.
- 3 pounds Salt.
- $\frac{3}{4}$  pound Gelatine.

Draw and clean the chickens, cut each in eleven pieces, place in kettle and cover with meat jelly, adding the salt and onions and spices in a bag; bring to a boil and simmer until tender; remove the chicken, and carefully skin and bone; add the gelatine, which has been soaked in cold water for an hour, to the liquor in the kettle, and stir until dissolved; then strain; if the liquid is not clear, clarify with white of egg.

Place the chicken in cans, cover with the liquid; cap, tip and process at 250 degrees, 1 lb. cans, 55 minutes; 2 lb. cans, 65 minutes.

### ROASTED TURKEY.

Same as chicken except that the turkey is roasted whole, then cut in can size pieces.

### BONED TURKEY AND TURKEY JELLY.

Same as chicken.

### ROASTED DUCK.

Same as turkey, adding to the spices one-half as much finely powdered sage as there is of pepper.

### ROASTED GOOSE.

Same as turkey, omitting the bacon, and using an equal weight of pepper and finely powdered sage.



Goose may be packed with sauer kraut; place the desired quantity of goose in the can; then completely fill with kraut, cooked same as for canning.

### ROASTED GUINEA FOWLS.

Same as chicken.

### ROASTED SMALL GAME BIRDS,

Such as Partridges, Pheasants, Quail, Grouse, Prairie Fowls, Woodcock, Snipe, Plover, Rail and Reed Birds, should be drawn and cleaned, dusted lightly with white pepper, placed in pan with a reasonable amount of butter and roasted until done. Then place in cans, dividing the gravy among them, solder up, tip, and process at 250 degrees,  $\frac{1}{2}$  lb. cans 55 minutes, 1 lb. cans 65 minutes, 2 lb. cans 75 minutes.



If you don't know where to buy what you need, such as machinery, supplies, picking crates, thermometers, etc., read THE CANNING TRADE, Baltimore, for a list of reliable sellers. The "Where to Buy" page at the back of each issue will be a big assistance, if the advertisements in the back of this book do not answer all requirements.

# MILK

Canned, condensed or evaporated milk is one of the large industries in this country. It is put up as plain or sweetened evaporated milk. The condensory is usually located in a good dairy section where a sufficient quantity of milk can be obtained by direct delivery in a short time. The production must be under similar conditions to those obtaining in city dairying. The cows must be healthy, the dairy sanitary, the milking done in a cleanly manner, and the milk cooled and delivered promptly. The matter of cooling and prompt delivery is more important than in the city delivery, for the production of a slight acidity will interfere with condensing to a consistency where the product will comply with the law. On being received at the condensory the milk is immediately tested for acidity and fat, and if the former exceeds 0.2 of 1 per cent., the milk is rejected for regular trade, though it may be accepted at a lower price for making a cheaper grade for confectioners' use.

The milk is run through a clarifier to remove any foreign material not taken out by the home strainer. It is next drawn into a large tank which will hold an amount sufficient to charge the pan. The milk of several herds is mixed in order to secure uniformity in the fat content. Each tank is tested for fat and solids, so that the exact ratio of concentration needed to give a certain result may be known. The milk is given a preliminary heating, usually to 190 degrees F., though there may be some variation in the different plants. The milk is then ready for the vacuum pan, which consists of a large copper kettle completely hooded and connected at the top with a pump. The milk is heated in this kettle by means of a coil on the inside. The pump draws a vacuum of 25 to 29 inches, and evaporation with violent agitation takes place at 130 degrees F.; the temperature is usually kept below 150 degrees. When the batch is nearly finished, a "strike" is made or a sample is drawn to test the consistency. The milk may or may not be run through a homogenizer to divide the fat into such fine particles that the cream will not rise in the finished product. It is next drawn into a filter, and in so doing the temperature may be raised to about 165 degrees or 170 degrees F., or the can may be filled cold.

The processing is done in retorts which differ from those used in vegetable packing, in that special crates are provided which carry the cans and revolve so that the contents will be kept in a smoother condition. Both the time and temperature for condensation vary in different factories, and in careful work tests are made on a few cans before the batch is processed. In general, it may be said that the temperature varies from 225 degrees to 240 degrees F., the time depending upon the degree of condensation desired, the condition of the milk and the size of the can. Twenty minutes for a 6-ounce and 28 minutes for a 12-ounce can at 240 degrees F. is safe. Immediately at the close of the cooking the cans are cooled, placed in cases, and shaken for three minutes.



# SOUPS

The canning of soups entails a great amount of labor, and particular care, but if properly handled should realize to the packer a good average profit on his investment.

There is very little in the way of mechanical equipment in the factory. The only requirement outside of the boiler is a number of open kettles or tanks, in proportion to the amount of work to be done. The tomato peeling tables will serve in pretty much the same capacity for preparing the vegetables and meats, and, with the usual trucks, cages and process kettles, the factory is mechanically complete.

The cage or crate referred to below should be made to suspend in the wooden tank while cooking; that is, it is made so that it will contain the meat or bones, or what the directions may call for, so as to keep them separate from the liquids, although cooked with them.

Good soups cannot be made without good materials, and an abundance of them. Pure, soft water must be used; if nothing but hard water is obtainable, soften it by dissolving  $\frac{1}{2}$  oz. Carbonate Ammonia in each 12 $\frac{1}{2}$  gals. Always use cold water to cover the meat; if time allows, let it soak for some hours before turning on steam; bring to the boiling point very slowly; never let it come to a full boil for at least an hour after turning on steam; if making stock for clear soup, watch it closely, as it comes to a boil, and skim off the coagulated albumen which rises at this time. If not promptly removed, it settles to the bottom and makes it more difficult to clarify.

Never boil soup hard; after the first boil, cut, steam and cook at a gentle simmer. *Never add salt to stock until the meat is taken out.*

Make stock in a square wooden tank with closed copper coils and draw off in bottom. Have a cage or crate or tinned iron or perforated copper, made to fit it neatly, in which to place the meat and other materials. The cage should be provided with a partition to keep materials separated when necessary, or a smaller cage may be used. The draw-off valve of the stock tank should be 3 or 4 feet above the floor, so that contents can be discharged directly into the cooling tanks.

Cooling tanks should be mounted on wheels, so that they can be readily moved from the kitchen to a cooler place. Provide a screen of wire or perforated copper to place over discharge pipe of kettles. Have tight-fitting covers for tanks and kettles.

## CONDENSED SOUPS,

Or concentrated soups, while they do not furnish the consumer quite so fine an article as the regular liquid soups, are nevertheless tasty and nutritious, and, owing to the very moderate cost of the diluted soup, enjoy a large sale. Packed in No. 1 cans, the directions are to dilute with 1 pint hot water, heat thoroughly and serve.

## PROCESS TIMES.

Unless otherwise noted the process time for soups in quarts is 50 minutes at 250 degrees; for condensed soups in No. 1 cans, 30 minutes at 250 degrees.

## ALBUMEN CLARIFYING SOLUTION.

One gal. white of eggs and shells from same, 1 gal. water. Wash the eggs, separate the white from the yolks, add the water to whites and beat; strain through muslin; crush the shells and mix with water and whites.

## ISINGLASS CLARIFYING SOLUTION.

Take 4 oz. genuine Russian Isinglass, cover with cold water and soak 6 hours; then drain off water and add 1 gal. water in which has been dissolved 3 oz. Tartaric Acid; stir and beat the mixture, adding cold water gradually until 3 gals. of a smooth, heavy syrup is produced. No heat whatever must be used in the preparation of this article.

## PLAIN SOUP STOCK.

- 1000 lbs. Beef.
- 125 gals. Water.
- 25 lbs. Chopped Onions.
- 25 lbs. Chopped Carrots.
- 25 lbs. Chopped Turnips.
- 10 lbs. Celery, or Celery Seed 1 lb.
- 1 lb. Whole Cloves.
- $\frac{1}{2}$  lb. Thyme.
- $\frac{1}{2}$  lb. Bay Leaves.

Cut off all the meat, crack and cut bones so as to expose all the marrow; place bones in crate and pile meat on top, drop in cold water in tank and bring to a boil; remove scum when it rises, then simmer seven hours. Then add the vegetables, cloves and thyme and simmer one hour longer; a half hour before time elapses add the bay leaves; when time expires, shut off steam, hoist out cage and gauge stock, adding sufficient boiling water to make 125 gallons.



Strain through a wet bag into cooling tanks; when it "jells" remove grease from top, and it is ready for use.

The cold grease from stock and bouillon may be purified by melting and washing in boiling water in which has been dissolved 1 per cent. bicarbonate soda. Carefully dip off the clear grease and when cold incorporate  $\frac{1}{2}$  oz. of salt per pound. This can be used in place of butter for browning meat.

### BOUILLON.

- 1000 lbs. Lean Beef.
- 125 gals. Water.
- 25 lbs. Chopped Onions.
- 15 lbs. Celery, or  $1\frac{1}{2}$  lbs. Celery Seed.
- 3 lbs. Salt.
- 1 lb. Green Parsley.
- 1 lbs. Ground White Pepper.
- $\frac{1}{4}$  lb. Bay Leaves.

Free the meat from all fat, chop fine, place in tank with the water, celery, onions and bay leaves; bring to a boil and skim promptly at the first rise. Simmer gently six hours; add the pepper and parsley 15 minutes before the cook is finished; pull out cage, add salt, gauge tank, add boiling water to make up loss. Run through a wet strainer into cooling tanks.

Remove grease and place jelly in kettle, melt and add  $62\frac{1}{2}$  pints Albumen Solution or 30 pints Isinglass Solution, mix thoroughly and boil 10 minutes; turn off steam, add 5 gals. ice-cold water and strain through canton flannel; add  $2\frac{1}{2}$  pints Caramel, place in quart cans, cap, tip and process.

### CONDENSED BOUILLON.

Make same as Bouillon, using three times the amount of Onions, Bay Leaves, Celery, Parsley, Salt and Pepper; dissolve in it  $2\frac{1}{2}$  lbs. Extract of Beef.

### CONSOMME.

- 500 pounds Lean Beef.
- 500 pounds Knuckle of Veal.
- 125 gallons Water.
- 20 pounds Chopped Leeks.
- 15 pounds Chopped Celery.
- 15 pounds Chopped Carrots.
- 32 pounds Butter, or Purified Fat.
- 1 pound Grain Pepper.
- $\frac{1}{4}$  pound Bay Leaves.
- $\frac{1}{4}$  pound Thyme.

Cut all the meat into pieces; place the butter in an iron pot over fire and brown; add the meat and stir until brown, then place meat in cage, handle, clarify and process same as Bouillon.

If a cheaper grade is desired, omit the butter and browning of meat; add 2 pounds salt, and color with one pint Caramel.

### CONDENSED CONSOMME.

Make same as Consomme, using three times the vegetables and spices, and dissolving in it  $2\frac{1}{2}$  pounds Extract of Beef.

### BARLEY SOUP.

50 gallons Plain Stock.

$12\frac{1}{2}$  pounds Barley.

1 pound Salt.

$\frac{1}{2}$  pound Parsley.

$\frac{1}{4}$  pound Ground White Pepper.

Wash the Barley in cold water; then drop into 30 gallons boiling water, and cook slowly about  $1\frac{1}{2}$  hours; then throw Barley into cold water. Place the stock in kettle, add the pepper and salt, and the parsley enclosed in a bag or perforated spice-box; bring to a boil and add the Barley, drained free from water; let come to a boil again, then turn off steam and remove the parsley; fill into cans.

When filling cans stir the kettle and dip from the bottom into a 3 or 4 gallon pail; have a dipper or measure with long handle, holding just enough to fill can properly; dip this measure to the bottom of pail each time; this insures the equal distribution of the Barley; cap, tip and process.

### BEAN SOUP.

25 pounds Pea Beans.

$12\frac{1}{2}$  pounds Ham, boned and skinned.

$37\frac{1}{2}$  gallons Boiling Water.

50 gallons Stock.

$2\frac{1}{2}$  pounds Salt.

$\frac{3}{4}$  pound White Pepper.

Cover beans with cold water and soak 12 hours. Dice the ham and place in small cage. Add the drained beans and ham to the  $37\frac{1}{2}$  gallons of boiling water and cook two hours, or until beans are very soft. Take beans and ham out of kettle, run beans through a rotary pulper, and return to water in kettle, adding the pepper, salt, stock and ham from cage. Place in cans, cap, tip and process.



## CONDENSED BEAN SOUP.

Make same as bean soup, but use on water, cooking the beans directly in the stock, and dissolve in it 1 pound Extract of Beef. It may be cheapened by substituting purified grease from stock for the ham.

## CHICKEN SOUP.

150 gallons Water.  
 800 pounds Chicken.  
 50 pounds Onions, chopped finely.  
 4 pounds Parsley.  
 $\frac{1}{4}$  pound White Pepper.  
 75 pounds Rice.

Clean the chicken, place in tank with the cold water, bring slowly to a boil and simmer three hours; skim off all the grease, add the onions and parsley, boil 10 minutes, then draw off and strain. Place in kettle, bring to a boil and add the rice. Cook 25 minutes, add the salt and pepper, shut off steam, place in cans, cap, tip and process.

If desired the white meat may be separated and added with the salt and pepper, or the entire chicken may be used for chicken gumbo or potted chicken.

## CONDENSED CHICKEN SOUP.

Make same as chicken soup, using 1 pound more salt and double the quantity of rice. Chop and add all the chicken meat, both white and dark.

## CHICKEN GUMBO SOUP.

50 gallons Chicken Soup.  
 50 pounds Chicken Meat.  
 50 pounds Lean Ham.  
 50 pounds Canned Okra.  
 30 pounds Canned Tomatoes.  
 $6\frac{1}{2}$  gallons Water.  
 1 ounce Cayenne Pepper.

Cut the ham in dice, place in kettle, cover with water and cook 45 minutes; add all the other ingredients, bring to a boil. Place in cans, cap, tip and process.

## CONDENSED CHICKEN GUMBO.

Make same as chicken gumbo soup (using chicken soup with double the quantity of rice), but do not use the water in which ham is boiled.

## CLAM SOUP.

- 1500 Quahaugs.
- 58 gallons Stock.
- 4 pounds Corn Starch or Flour.
- 5 pounds Butter.
- $\frac{1}{2}$  pound Ground White Pepper.
- $\frac{1}{2}$  pound Parsley, chopped fine.
- 2 pounds Salt.

Open the clams and wash well in cold water, chop fine and place in kettle with the stock, turn on steam and melt the stock. Melt the butter and mix with the flour. Add this to contents of kettle and stir continuously until it boils, then turn off steam. Add the pepper, salt and chopped parsley. Place in cans, cap, tip and process.

## CREAM OF ASPARAGUS SOUP.

- 25 gallons Asparagus Pulp.
- 25 gallons New Milk.
- 25 gallons Stock.
- 4 pounds Corn Starch or Flour.
- 5 pounds Butter.
- 2 pounds Salt.
- $\frac{1}{2}$  pound Ground White Pepper.

Place the milk in kettle and bring to a boil. Melt the butter and mix intimately with the corn starch or flour. Add to the milk and stir continuously until it thickens. Add the stock, asparagus pulp, salt and pepper; bring to a boil; place in cans, cap, tip and process.

Milk may be omitted and stock substituted, in which case use double the amount of thickening.

## CONDENSED CREAM OF ASPARAGUS SOUP.

Make same as cream of asparagus soup, using double the amount of salt and spice, one-half more butter and flour and adding 1 pound Extract Beef.

## CREAM OF CELERY SOUP.

Make same as cream of asparagus soup, using pulped celery and adding one-half pint onion juice.

## CONDENSED CREAM OF CELERY SOUP.

Make same as condensed cream of asparagus soup, using pulped celery and adding one-half pint of onion juice.



## CREAM OF PEA SOUP.

Make same as cream of asparagus soup, using 12½ gallons pulp from green or canned peas.

## CONDENSED CREAM OF PEA SOUP.

Make same as condensed cream of asparagus soup, using 12½ gallons of pulp from green or canned peas.

## GREEN TURTLE SOUP.

Prepare same as for canning. When cooking the meat, head, etc., in liquor in which the shells were boiled, for each 10 pounds meat add 1 pound chopped onions, ¼ ounce bay leaves, ½ pound pot herbs and 1 pound dried ham cut in small pieces. Cook until meat is done, then remove cage containing meat and strain liquor. In the meantime melt ¾ pound butter and mix with ½ pound flour, add 1 quart liquor and bring to a boil, then add 2 ounces sugar and 1 quart wine. Mix the meat liquor and thickened liquor all together with the chopped yolks of 2 dozen hard-boiled eggs, juice of 1 dozen lemons and ½ ounce of cayenne pepper, place in cans, cap, tip and process.

## JULIENNE SOUP.

100 gallons Stock.  
 25 pounds Carrots.  
 12½ pounds Turnips.  
 15 pounds Celery.  
 5 pounds Onions.  
 5 pounds Leeks.  
 5 pounds Cauliflower.  
 5 pounds Peas, canned.  
 5 pounds Asparagus Tips, canned.  
 3 pounds Salt.  
 ¼ pound Ground White Pepper.

Pare and cut the carrots and turnips in straws, cut the celery in half-inch pieces, chop the onions, cut leeks in quarter-inch pieces and break cauliflower into small pieces. Put the stock in kettle and bring to a boil, add the carrots and turnips and cook 10 minutes, add the celery, onions, leeks and cauliflower and boil 10 minutes more. Add the asparagus, peas and salt and pepper. Turn off steam and draw off the stock, divide the mixed vegetables among the cans and fill with the stock, cap, tip and process.

## CONDENSED JULIENNE SOUP.

Make same as julienne soup, using but 50 gallons stock, in which dissolve 1 pound Extract of Beef.

## MACARONI SOUP.

- 50 gallons Stock.
- 12½ pounds Macaroni.
- 1½ pounds Salt.
- ¼ pound White Pepper.
- ½ pound Parsley.

Break the macaroni in small pieces, throw in salted boiling water and cook 30 minutes; then throw in cold water; now handle and process same as barley soup.

## CONDENSED MACARONI SOUP.

Make same as macaroni soup, using 25 gallons stock and adding 1 pound Extract of Beef.

## MOCK TURTLE SOUP.

- 60 gallons Water.
- 1 gallon Sherry Wine.
- 50 Calves' Heads.
- 50 Calves' Hearts.
- 4 dozen Lemons.
- 1½ pints Worcestershire Sauce.
- 25 pounds Calves' Liver.
- 5 pounds Chopped Carrots.
- 5 pounds Chopped Onions.
- 5 pounds Chopped Turnips.
- ½ pound Whole Cloves.
- ¼ pound Sweet Marjoram.
- ½ pound White Pepper.
- 2 pounds Mixed Green Pot Herbs.
- 10 pounds Butter.
- 8 pounds Flour.
- 3 pounds Salt.

Unjoint the jaws and take out the brain, clean thoroughly with boiling water; split the hearts and trim liver; place in tank with the cold water, turn on steam and skim at first boil, then skim about 15 minutes later; simmer two hours or until meat is tender. Take from tank the hearts, liver and heads; remove meat and tongues from head.

Return the bones to kettle with the vegetables, herbs and cloves. Cook slowly two hours, draw off and strain into cooling tank. Cut the liver into dice, slice and chop the hearts, tear meat into small



pieces, chop the tongues, place the butter in an iron pot and brown, then add the flour and brown. Skim the grease from the stock and place in kettle, add the browned flour, mix and bring to a boil, stirring all the time. Add the meat, tongues, heart and liver, boil two minutes and shut off steam. Add the juice of the lemons, sauce, pepper, salt and sherry wine; place in cans, cap, tip and process.

### CONDENSED MOCK TURTLE SOUP.

Make same as Mock Turtle Soup, using 45 gallons of water instead of 60, and adding double the quantity of Worcestershire Sauce, pepper and lemons and 1 pound Extract of Beef.

### MULLIGATAWNEY SOUP.

100 pounds Chicken.  
 4 pounds Sliced Onions.  
 2 pounds Butter.  
 1 pound Salt.  
 1 pound Curry Powder.  
 2 ounces Whole Cloves.  
 1 dozen Lemons (juice of).  
 20 gallons Water.

Clean the chicken and cut to can-hole size. Put the butter in an iron pot with the onions and chicken and brown.

Add the curry, salt, cloves, and lemon juice. Place this mixture in kettle with the cold water, bring slowly to a boil, simmer two hours, then take out the chicken, divide among the cans, fill with the hot liquor, cap, tip and process.

Mulligatawney may be made from the regular chicken soup by adding 40 pounds cooked chicken meat, juice of 2 dozen lemons, 8 pounds of onions browned in grease and 2 pounds curry powder to 100 pounds soup.

### CONDENSED MULLIGATAWNEY SOUP.

To 40 gallons condensed chicken soup add 40 pounds chopped chicken meat or veal, juice of 4 dozen lemons, 12 pounds onions browned in grease, and 2 pounds curry powder.

### OX TAIL SOUP.

125 gallons of Water.  
 1/2 gallon Sherry Wine.  
 1 quart Caramel.  
 1000 pounds Ox Tails.  
 10 pounds Butter or sufficient.  
 25 pounds Chopped Onions.

25 pounds Chopped Carrots.  
 25 pounds Chopped Turnips.  
 ½ pound Whole Cloves.  
 ¼ pound Bay Leaves.  
 4 pounds Salt.  
 ½ pound Ground Black Pepper.

Joint or chop in 1-inch pieces the ox tails, place those larger than can-hole size in a small cage; melt the butter in an iron pot and brown the small pieces; skim out and place in another small cage. In another separate cage place the vegetables with the bay leaves and cloves. Place all in tank with the cool water, turn on steam, bring to boil and simmer 1½ hours, then remove cage containing small pieces of tail. Cook remainder a half hour, or until the large pieces are very tender; then take them out, separate meat and return to kettle. Shut off steam, remove the vegetables, add the salt, pepper, sherry and caramel, divide the small joints among the cans, fill with the hot liquor, cap, tip and process.

#### CONDENSED OX TAIL SOUP.

Make same as ox tail soup, using 100 gallons water and double the quantity of everything except ox tails and butter, and add two pounds of extract of beef. Thicken with 10 pounds of corn starch, mixed with cold water, before the salt, pepper, sherry and caramel are added.

#### PEA SOUP.

Make same as bean soup, using 25 pounds split peas in place of beans.

#### CONDENSED PEA SOUP.

Make same as condensed bean soup, replacing beans with split peas.

#### RICE SOUP.

Make same as Macaroni, using 12½ pounds rice instead of macaroni.

#### CONDENSED RICE SOUP.

Make same as condensed Macaroni, using 12½ pounds rice instead of macaroni.

#### TOMATO SOUP.

84 gallons Pulp from machine, or its equivalent in canned  
 pulp.  
 28 gallons Water.



- 12 pounds Salt.
- 12 pounds Butter and 11 pounds Sugar.
- 6 pounds Flour.
- 10 pounds Chopped Onions.
- ½ pound Chopped Garlic.
- 6 ounces Ground White Pepper.
- 6 ounces Bay Leaves.
- 1 ounce Powdered Saigon Cinnamon.

Place the butter and pulp in kettle and bring to a boil; then add the onions and garlic and simmer one hour, adding water to make up for loss by evaporation. When the cook is half finished, add the bay leaves, and when within ten minutes of the finish add the salt, sugar and pepper; and two minutes before the time is up add the cinnamon and the flour mixed with water; boil two minutes, turn off steam, run through rotary pulper or shaker, place in cans, cap, tip and process No. 3 cans 45 minutes at 240 degrees.

#### CONDENSED TOMATO SOUP.

- 120 gallons Pulp from machine or its equivalent in canned pulp.
- 1 gallon Water (cold).
- 14 pounds Salt.
- 12 pounds Sugar.
- 15 pounds Onions, chopped fine.
- 2 pounds Butter.
- 1 pound Beef Extract.
- 5 pounds Corn Starch.
- 6½ ounces Ground White Pepper.
- 1 ounce Ground Saigon Cinnamon.
- ½ ounce Mace.

Place the pulp and butter in a kettle and bring to a boil, then add the onions and cook 40 minutes. When the cook is within 10 minutes of the finish, add the extract of beef, salt and sugar and pepper; when within 2 minutes, add the cinnamon and mace; mix the cold water and corn starch, stir in, and when it boils, turn off steam; then run through rotary pulper or shaker, place in cans, cap, tip and process No. 1 cans 30 minutes at 240 degrees.

#### VERMICELLI SOUP.

Same as macaroni soup, using 12½ pounds vermicelli and breaking bundles in three lengths.

#### CONDENSED VERMICELLI SOUP.

Make same as condensed macaroni soup, using 12½ pounds vermicelli and breaking in three lengths.

## VEGETABLE SOUP.

- 100 gallons Stock.
- 50 gallons Water.
- 15 pounds Carrots, diced.
- 20 pounds Turnips, diced.
- 20 pounds Sweet Potatoes, diced.
- 25 pounds White Potatoes, diced.
- 20 pounds Sugar Corn, canned.
- 10 pounds Peas, canned.
- 10 pounds Lima Beans, canned
- 20 pounds Tomatoes, canned.
- 12 pounds Rice.
- 5 pounds Salt.
- 1 pound Ground White Pepper.

Wash, pare and dice the vegetables. Put the water in the kettle with the carrots and turnips, bring to a boil and cook one-half hour; then add all the other vegetables except the canned stock and the rice; bring to a boil and cook 20 minutes; then add the stock, salt, pepper and canned vegetables; bring to a boil, shut off steam, place in cans, cap, tip and process.

## CONDENSED VEGETABLE SOUP.

Make same as vegetable soup, omitting the water and cooking in stock, adding 2½ pounds beef extract. This may be cheapened by using more rice and less vegetables.

## CLAM CHOWDER.

- 5000 Quahaugs, or Hard Shell Clams.
- 15 pounds Onions.
- 50 pounds Bacon.
- 50 pounds Tomatoes.
- 50 pounds Potatoes.
- 2 pounds Salt.
- 1 pound Ground White Pepper.
- ½ pound Parsley, chopped fine.
- ¼ pound Thyme.
- ⅛ pound Sweet Marjoram.
- 30 gallons Water.



Wash the clams, either steamed or raw shucked, in cold water; drain and chop. Cut the bacon and potatoes in dice. Place the water, clams, onions, bacon, tomatoes and potatoes in kettle, bring to a boil and cook ten minutes; then add other ingredients; stir thoroughly and place in cans, cap, tip and process No. 3 cans 80 minutes at 250 degrees.

### CONDENSED CLAM CHOWDER.

Make same as clam chowder, using half the quantity of water, but after all ingredients are added and mixed and steam turned off, draw the liquid from bottom of kettle, fill the cans with the solid materials and cover with the liquid; then process No. 1 cans 40 minutes at 250 degrees.



# PRESERVES

The U. S. Standards are :

Preserve is the sound product made from clean, sound, properly matured and prepared fresh fruit and sugar (sucrose) syrup, with or without spices or vinegar, and conforms in name to that of the fruit used, and in its preparation not less than forty-five (45) pounds of fruit are used to each fifty-five (60) pounds of sugar.

Honey preserve is preserve in which honey is used in place of sugar (sucrose) syrup.

Glucose preserve is preserve in which a glucose product is used in place of sugar (sucrose) syrup.

---

*The Manufacture of Food Products* more clearly expresses the meaning than "preserving," which, in its broad sense, covers not only the combination of fruits in heavy syrup, but also indicates the combination of sugar and various food substances in other forms, besides many incidental lines in which sugar is but a small factor, though classed under this general head. This is the most promising new field to the canner and to which he naturally first turns for a winter pack. The line and grade of products apt to be most profitable depends on the character, variety, volume and cost of the raw materials obtainable locally modified by the distance from, and consequent transportation charges on, supplies that must be purchased outside.

Under usual conditions factories fitted up for making jellies, preserves and butters as the primary object, and where possible are arranged according to the gravity system as explained under Apple Juice. The capacity and requirement of factories, the number and size of tanks, kettles, etc., the character and elevation of buildings vary so much that a specific plan is required for each and it is not practical to give more than a mere outline of the arrangements of plants here.

## THE BUILDINGS.

When a new building is erected especially for the purpose it is easy to provide skylights over the cookers and kettles, but in an old building it is sometimes difficult. When the cooking, filling and finishing departments are in the same room, means must be provided to carry off the steam; wings extending down in front of the kettles with an exhaust fan are quite effectual, but the better plan is to build, outside the building, on brackets, a gallery with dog house skylights, or to build a solid partition between the cook room and



finishing department. Goods finished for sale must not be stored in these rooms.

Water-tight floors are a necessity in the juice and cook rooms, and are an advantage in the finishing room. Cement and asphaltum may be used, but wood is preferable. A satisfactory floor is made with ship plank, well caulked and pitched; or over a common floor place 2 layers of 3-ply roofing felt, cover with a heavy coat of hot pitch, and in this, while hot, lay a tight maple floor. Still better, but quite expensive, use sheet lead, soldered together, instead of roofing paper. When practical slope the floors to the sewer opening.

An ample supply of cold water is required either piped directly to each kettle and tank or tapped at convenient points so that a hose will readily reach them. Wash tanks of reasonable size must be established and provided with a steam jet for heating.

### MECHANICAL EQUIPMENT.

On the upper floor, elevated above the load line of the press, put the waste cookers, and on the floor with press place the glucose tank (with steam-coil in bottom, so that glucose may be warmed enough to make it flow readily), if the glucose is pumped from tank cars; or, the skids or trestle for draining barrels if it is purchased in this way; in which case place the glucose tank on same level with the juice storage tank. If glucose is purchased in barrels, also provide on this floor steam jets for steaming out the barrels.

From the glucose tank lead a 3-inch pipe with a like opening, controlled by a quick discharge valve, to each kettle. Let the valve end be one foot above and one foot away from the kettle; screw in a short nipple with an ell on end, in this loosely screw a service ell.

In this ell screw a pipe 2 inches long. When drawing glucose pull the pipe down over kettle; when not in use set upright; this prevents the drip of glucose in kettle and keeps pipe out of the way.

From the juice storage tank, placed below the press and above the kettles, lead a 1½ or 2-inch pipe discharge into each kettle and also provided with a valve and swinging pipe; these pipes may be of iron, with brass pipe below the valve, if they are kept filled all the time either with juice or water; if used only at intervals use brass or copper pipes.

Place all the large jacketed kettles with bottom outlets on the outer edge of a platform 6 feet to 8 feet wide and 3 feet above the floor, so that the contents may be readily discharged into the cooling tables and "setting" tanks. Provide one of these with a mechanical stirrer for use in fruit butters and other pasty masses.

Where a series of small kettles without bottom outlets, of the same or different sizes, are installed, provide a table, or counter,

of 2-inch stuff, 3 feet 6 inches from the floor, with openings so arranged that the kettles will fit therein with tops level with the surface, of course, supporting them with legs in the regular way. This counter will prevent slopping and protect kettles when filling. Each kettle and closed coil should be provided with an individual trap; if several are connected with one trap, provide both a globe and check valve for the exhaust from each kettle. When traps are not provided and a series of kettles exhaust into one main, use a check valve on each exhaust.

It is economy to cover the jackets of copper kettles with asbestos or magnesia to prevent radiation of heat. This can be accomplished on a plain kettle by riveting on a collar just above the jacket to support wire netting which will hold the insulating material in position; or, if preferred, a sectional metal covering can be attached; for a flanged kettle, bolt the collar to the lower flange.

Provide a gauge stick, suitably marked, for each kettle, so that the contents may be accurately measured at any time. A permanent gauge should be placed in each tank. Closed coils for round tanks are best coiled from circumference to center, carrying the exhaust out through bottom of tank. For square tanks build a square coil of copper, or if iron use short pipes with ells, carrying exhaust out through bottom near the center. Tanks with coils arranged in this manner, conducting the live steam around the outside first, and discharging exhaust in middle, will cook much like jacketed kettles, "throwing" the liquid from sides to center.

### COOKING.

When starting to cook with kettles or coils not connected with trap, open the exhaust valve wide, turn steam on slowly until all water is forced out of jacket, then turn on full steam pressure and nearly close the exhaust valve, allowing just sufficient opening to let the condensed steam escape. When attached to traps open steam valve slowly until full steam pressure is on.

The effect of prolonged, or secondary, cooking on fruits in heavy syrup is more marked in its changes of colors and flavor than on vegetables and fruit in brine or light syrup to which attention has already been called.

### COOLING.

In all instances when jams or preserves are to be placed in large packages, they must be cooled if the flavor and color are to be retained. The best and cheapest method is to spread out on a cooling table, which is nothing more than a shallow box mounted on wheels or castors, so that it can be readily moved from place to place. A box made of 1½-inch stuff 3 feet 6 inches by 7 feet 6 inches by 6 inches deep is a convenient size, and must be mounted



low enough to run under draw-off pipes from kettles. It should be metal lined. If the table is intended also for meringue pie filler, make 10 inches deep, with a spout and shut-off slide at one end.

A cooling apparatus for syrup and catsup, where the intermittent system of cooking is adopted, may be made of copper on the plan of an upright, tubular boiler, replacing the steam with a constantly changing current of cold water from bottom to top, and replacing the fire with the substance to be cooled. The straight tubes can be readily scrubbed with a round brush on a long handle, and while this is not necessary with syrup it is with catsup, every particle of which must be removed after the day's run

Mount all tables, on which glassware is filled, on castors.

A set of combination scales (with small platform and pan) placed on a box, fitted to contain a hatchet, extra weight, scoops, etc., and provided with castors, will prove a great convenience. Keep a small set of scales in a room or closet, adjoining the kettles where the spices and the various articles of this nature are stored under lock and key. For obvious reasons no one but the chief cook or his deputy should be allowed in this room.

When the method of diluting sugar preserves with jelly is adopted set a plain copper kettle (same as used for setting up with brickwork) flush with the surface of a suitable short-legged table mounted on castors; mix the preserves, jelly and coagulant in this and allow to partially set before filling into packages.

Racks mounted on wheels to hold the crocks or pans used in the modified Wiesbaden or maceration processes are preferable to stacking on floor, or using stationary racks.

### THE PULP MACHINE.

Where space and conveniences allow, the large pulping machine used for preparing fruit butters, etc., is best placed on the same floor with the press; if the same cooker is used both for "apple waste" and these materials, place the machine so that the same trough will carry to press and feed pulper; run the finished pulp directly into kettle through a chute. For good work run the machine 200 to 250 revolutions per minute, feed regularly and slowly, so that it will not be necessary to choke the hole from which waste is discharged. Nothing is gained by over-crowding the machine. The life of the inner sieve may be lengthened by riveting to it a strip of copper 2 inches by 15 inches about 2 inches below the frame, covering a point at the feeding end where the paddles first throw the material and where the first break generally occurs. Use a small pulper provided with adjustable brushes and fitted with a metal plate containing the smallest obtainable perforations as a finishing machine for catsups; always fit this plate snugly to supporting sieve or plate containing large holes; the interior

metal fittings, except the shaft, should be brass or bronze. Run the machine 250 to 300 revolutions per minute. Coat the bearings with graphite. *Clean these pulpers daily and in hot weather remove sieves.*

*Vinegar* of good quality is a desideratum; cider vinegar, made from sound fruit, is the best, but is hardly obtainable in most localities. Test manufactured vinegar for sulphuric acid and strength. A crude, but approximately correct method of testing strength is to dissolve 100 grains bicarbonate potash in enough water to make exactly 10 fluid drams; take one fluid ounce of the vinegar and add enough of the solution to neutralize it (judge this point with red and blue litmus paper, when both are just on the turn the liquid is neutral), the amount of the potassa in the solution used shows the grain; *i. e.*, if 6 drams solution is required, it is 60 grain vinegar; if  $4\frac{1}{2}$  drams, it is 45 grains.

*Pure salt*, in addition to its preservative and flavoring qualities, will, if added to sugar in proportion to  $\frac{1}{2}$  of 1 per cent. to 1 per cent., accentuate its sweetness and may be used to advantage in all sugar goods. Salt containing a large percentage of sulphates or magnesia is not suitable for this purpose.

As a disinfectant, when the rust stain is not objectionable, sulphate of iron (copperas) is probably the cheapest and best. Dissolve 1 pound to each gallon of water, and use freely. Creolin is a valuable disinfectant, but has a disagreeable odor.

When thought necessary, and *when admissible under the pure food laws*, benzoate of soda may be used in sweet goods in proportions not greater than one-tenth of 1 per cent.

To calculate the proper amount for a batch, reduce the total to ounces (multiply by 16) and point off three places; for instance, the batch contains 300 pounds—4800 ounces—four and eight tenths ounces (4.8) to be employed.

(See Pure Food Laws at end of book).

Where preservatives are not admissible, all grades of goods may be sterilized at 190 degrees; pure sugar and fruits may be processed at 212 degrees.

When cooking pure fruit and sugar goods the best results are obtained by starting the cook with a low steam pressure and gradually increasing the pressure as the syrup becomes heavier. When cooking fruit and juice together use a high steam pressure up to 80 or 90 pounds.

*In preserving dried fruits*, soak in cold water, and when plump handle the same as fresh fruit.



## FRUIT PULPS FOR MARMALADE (ENGLISH STYLE JAM).

Prepare the fruit and place in jacketed kettle, with 5 per cent. of water for juicy and 10 per cent. of water for dry fruits; turn on steam, bring slowly to a boil and cook 5 minutes, stirring occasionally; place in No. 10 cans, seal and process 30 minutes at 212 degrees. After processing drop in cooling bath.

## PURE FRUIT WITH SUGAR.

The general process applied to this class of preparations is exactly the opposite of the well-known diffusion process as used in the manufacture of sugar from cane and beets. Raw fruits placed in a saturated solution of sugar will shrink and become tough and unsightly, owing to the rapid absorption of the fruit juice by the sugar, which in a saturated or super-saturated solution has a greater affinity for the juice than the fruit has sugar, thus preventing the proper interchange. When fruit is placed in a weak solution of sugar diffusion takes place and in time the percentage of sugar in the syrup and in the fruit will be equal; if now the syrup is slightly strengthened by adding more sugar, the diffusion again equalizes the sugar strength of the syrup and fruit; if this process is continued the fruit may be saturated or any desired amount introduced. Syrup at 26 degrees and below readily diffuses in fruit; above that degree it takes considerable time. Glucose acts in the same manner, and may be used alone or mixed in any proportion with sugar syrup. When permissible, a proportion of glucose, say 33 1-3 per cent., should be used as it prevents the crystallization of the sugar in the syrup and the goods are not so "dead" sweet as when pure sugar alone is used. During the entire process the fruits should remain plump, and if any signs of shrinking or wrinkling are observed, immediately reduce the strength of the syrup by adding a little water. When the syrup used reaches the density of 33 per cent. the further density must be increased, in part, by glucose, or the syrup must be boiled with  $\frac{1}{4}$  ounce acetic acid, or  $\frac{1}{4}$  ounce cream tartar, for each gallon.

The saturating may be done in covered stone jars of 2 to 3 gallons capacity, having an opening, to be stopped with a cork, in the side at the bottom to draw off the syrup and provided with a perforated diaphragm fitting inside the jar; or in enameled flat pans with a suitable arrangement for keeping the fruit under the syrup. Surplus syrup may be used for future operations; clarified and used for packing fruits; used to flavor jellies or sold for soda fountain use. Unless otherwise mentioned, the gravity of the syrup is to be taken at the boiling point.

## CANDIED FRUITS

Fruits to be candied or crystallized must be under-ripe. Canned fruits, specially selected and treated, may be used. Fruits may be candied by the quick process as given for orange peel; provide the tank with a series of sieves on which to place the fruits. By the French process fruits are bleached in sulphur fumes from 6 to 12 hours before being placed in syrup; artificial color is added to the syrup at 28 degrees when necessary.

### APRICOTS.

Remove the seed with a pitting spoon; place in warm water and bring very gradually to near the boiling point; as they float to the top; place in jars; pour over them 25-degree syrup; drain off in 24 hours; re-boil, and add enough sugar to make syrup 25 degrees again; pour over fruit; repeat the operation every day until 27 degrees is reached; then every two days until 31 degrees is reached; then every three days until 33 degrees is reached; then every four days until 36 degrees is reached; allow to remain six days, then wash in 30-degree syrup, place on trays and put in drying room.

### BLACKBERRIES.

Same as strawberries.

### CITRON, IMPORTED, FOR MINCE MEAT.

Soak in several changes of cold water to remove salt; then candy same as orange peel.

### CITRON, DOMESTIC, FOR MINCE MEAT.

Peel off the green rind; cut in 1-8th or 1-16ths, according to size; cut out all the seed pulp, leaving only the firm outside flesh; soak this in two changes of strong brine for 12 hours each; then freshen in cold water; place in cold water; bring to a simmer and cook until tender; then candy the same as orange peel.

### CHERRIES.

Place in jars and cover with boiling 20-degree soup; in an hour draw off; add sugar to 24 degrees; repeat this every day until syrup remains at 24 degrees; then gradually increase 2 degrees at a time until 36 degrees is reached; then wash in 30-degree syrup; spread on trays and dry.



## CRAB APPLES.

Same as pears.

## NECTARINES.

Same as peaches.

## PEACHES.

Drop the peaches in boiling water for a moment, then rub off skin; put in warm water, bring slowly to a boil, and skim out as they rise; place in jars and cover with a 25-degree syrup; then treat same as apricots.

## PEARS.

Select small, hard, underripe pears; thrust a copper needle several times through the pear from blossom end to stem; peel the pears and scrape them; place in kettle with cold water; bring to a simmer and cook until pears are softened; place in jars and cover with boiling 20-degree syrup; in 12 hours reboil and increase strength to 22 degrees; then gradually increase to 36 degrees; wash in 30-degree syrup and dry on trays.

## PINEAPPLE.

Peel, remove all eyes and cut in slices a half inch thick; place in jars and cover with boiling 16-degree syrup; in 24 hours reboil syrup and add sugar to make 18 degrees; repeat every day, gradually increasing to 36 degrees; then wash in 30-degree syrup; place on trays and dry; when dry, cut a half-inch hole through core. If intended for Wiesbaden fruit, cut in pieces of suitable size and treat same way, bringing to 33 degrees.

## PLUMS, DAMSONS AND GAGES.

Take canned, unripe fruit which had the skin well pricked before processing; cut and drain off juice; place in jars, and cover with warm 25-degree syrup; drain and reboil to 25 degrees in eight hours; then gradually increase every day. When saturated to 36 degrees, wash in 30-degree syrup and dry.

## QUINCES.

Pare and core, cut in quarters or eighths, according to size, place in kettle; cover with cold water, and bring nearly to a boil; drain off water and repeat; then place in jars and cover with cold 18-degree sryup, each 24 hours, draw off syrup, increase 2 degrees and pour back cold until 36 degrees is reached; wash in cold 25-degree syrup and dry. If the syrup jells during the process, wash out with warm water and replace with fresh cold syrup.

## RASPBERRIES.

Same as strawberries.

## STRAWBERRIES.

Select firm, underripe berries, hull, place in jars and cover with cold 28-degree syrup, draw off and repeat with 28-degree syrup in 24 hours; then replace with 18 degrees, and each day increase 1 to 2 degrees; if berries appear to soften increase strength, if they shrivel, decrease; continue to 36 degrees, wash in cold 25-degree syrup and dry.

## ORANGE PEEL.

Place the orange peel in cold brine (5 lbs. salt, 2½ gals. water) in kettle and bring just to a boil; draw off and replace with cold water; bring to a boil; drain off and again add fresh cold water; bring to a boil and cook until tender; place the peel in a wooden tank provided with a copper coil, and draw off in bottom, also with a grating at top to prevent floating. Cover with 12-degree syrup and turn on steam, keep the temperature just below 212 degrees; as the syrup evaporates replenish with 12-degree syrup; continue this until the syrup in tank marks 34 degrees; then drain off syrup; place the peel, concave side down, on sieves to drain; then place on trays, concave side up to dry; if it is desired to load the peel with sugar, pour syrup in each half before drying.

## CANDIED FIGS.

Take small, underripe figs; prick the skin with needles, and thrust through several times with a large needle; place in water, bring to a boil and cook until tender; cover with 12-degree syrup and candy same as orange peel to 35 degrees; then wash in 30-degree syrup and dry.

## CANDIED GINGER.

Take imported green ginger in syrup and saturate to 34 degrees same as orange peel, and dry without washing.

## CANDIED TOMATOES OR TOMATO FIGS.

Select small, sound, ripe, yellow tomatoes; scald and peel; place in kettle with half their weight of sugar and warm gently until the sugar is absorbed; then place carefully on trays to dry, sprinkling with granulated sugar from time to time; when perfectly dry pack with granulated sugar between each layer.



## CRYSTALLIZED FRUIT.

Use fruit prepared by the preceding processes in 36-degree syrup. For the large fruit, remove from the syrup and drain on sieves; then wash off all syrup with warm water. For the small fruits, drain off the syrup and wash with warm 10-degree syrup. Place fruit on trays and dry; the surface must be entirely dry and not stick to fingers when handled. Have a box of suitable size containing a stack of tinned copper sieves 1½ to 2 inches apart; lay the fruit on these sieves, the larger pieces singly and the smaller in layers 2 or 3 deep. Make 33-degree syrup (it must be exactly 33 degrees at 212 degrees F.), cool and cover the fruit, allow to remain 6 to 12 hours, or until the fruit is covered with sugar crystals of sufficient size; then drain off syrup and dry fruit on sieves.

## WIESBADEN FRUIT.

Take fruit saturated with 33-degree syrup by same process as candied fruits; pack in tall pint jars and fill with uncolored, hot 32-degree syrup, which has been boiled with acetic acid or cream tartar. Seal jars and sterilize one hour at 190 degrees. The French and German Wiesbaden fruits are bleached with sulphur at the first operation, then colored artificially if required.

## WIESBADEN FRUITS, MODIFIED PROCESS.

*Use a tilting jacketed kettle of 5 gals. capacity or less.* For canned raspberries, strawberries and blackberries cut can and drain off juice; use sugar in proportion of 1 lb. to 1 lb. of drained berries. Make the sugar into 38-degree syrup, boiling with acid, place the fruit in and give a very gentle boil for one or two minutes; dump in pan and set aside 24 hours; then drain off syrup; add sugar to 30 degrees (cold, place in kettle, berries and syrup; bring to a boil and add enough sugar to make syrup 33 degrees (hot); then turn in pan for 24 hours. Then pack the fruit as nearly solid as possible in fruit jars, reserving the surplus syrup for next operation.

For all other canned fruits turn juice and fruit in kettle; add sugar enough to make 20 degrees syrup; bring just to a boil; dump in pan and set aside 24 hours; then drain off syrup; add sugar to make 25 degrees, boil and pour back on fruit; next day add sugar to 30 degrees; next day to 35; next day drain off syrup and pack fruit solid in jar; then cover with hot 33-degree syrup boiled with acid. Seal tops and sterilize one hour at 190 degrees.

Process for fresh fruit (except berries); prepare fruit and place in kettle with cold water; bring to a boil; cook until tender; make syrup up to 20 degrees, and proceed same as with canned foods. For fresh berries give a little longer cook in the syrup than for canned fruit and handle the same.

## COLD PROCESS.

Fruits for this process must be fully ripe and moderately soft. Proceed as directed under candied fruits; do not cook the fruit. Make the syrup 2 degrees less than directed there, and make from cold water and sugar by agitation; saturate the fruit up to 33 degrees, adding the sugar and dissolving by agitation each time. The syrup may be made by heat, but must be cooled to 100 degrees or less before pouring on fruit. The operation must be carried out in a cool place. Fruits by this process are adapted for packing in cordials or brandy.

## SUN-COOKED PRESERVES.

This operation is best carried on in a glass house on the roof, or in an ordinary hot house. Place selected ripe fruit with an equal weight of sugar in the jar or tumbler in which it is to be sold. Do not cover, but protect from insects by netting. Expose to the direct rays of the sun for a week or ten days until it thickens and partly jells; then seal the package and label. Do not use larger than an 8-ounce tumbler; 4-ounce is the preferable size. Wild strawberries are especially fine made by this process, and currants compare favorably with Bar-le-Duc.

## PURE SUGAR AND FRUIT PRESERVES, MACERATION PROCESS.

Cook in tilting jacketed kettles. Provide a sufficient number of earthenware crocks or enameled pans of a capacity to hold 30 pounds (15 pounds fruit, 15 pounds sugar) for two days run—also a number of 1-inch by 1-inch wooden strips a trifle longer than the diameter of the crocks or pans, to use in stacking.

Place 15 pounds prepared fruit mixed with 15 pounds sugar in pan and allow to remain 6 to 12 hours, or until the juice of the fruit has dissolved the sugar (with very dry fruit it may be necessary to add a little water, one or two ounces to each pan to start the juice); then place in kettle and cook with little or no stirring until syrup drops in jelly from paddle. Dump in pan and set aside for a few minutes; then stir and set aside until cold; stir again and transfer to package; sterilize 1-pound jars 1 hour at 190 degrees.

## HOME-MADE STYLE PRESERVES.

Proceed same as for maceration process, using three-quarters of a pound of sugar per pound of fruit; place in kettle and simmer gently until fruit is soft. Do not cook down; the syrup should be quite thin; divide the fruit among the jars; fill with syrup; seal



and sterilize 30 minutes at 212 degrees for pints, and 1 hour for quarts. Use the ordinary "Mason" or similar family jar for this quality.

### HOT PROCESS.

If from selected fruit and carefully cooked in small kettles, makes high grade for small packages; if from good fruit and cooked in 30 to 60-gallon kettles, makes high grade for large packages; if poor fruit cooked in large kettle is adapted for storing in half-barrels or barrels for use in apple juice and glucose goods.

Sterilize the glass goods: 1-pound, 45 minutes at 190 degrees; pints, 45 minutes at 190 degrees; quarts, 90 minutes at 190 degrees.

Before filling in packages place on cooling table, and if for glass goods allow to set; if for large packages, cool to at least 160 degrees. Under-ripe fruits will present the best appearance; ripe or over-ripe will give the best flavor. Observe the same precautions in bleaching and hardening as given under canning of respective fruits. In using canned food cook only half the can liquor.

*Apricots*.—Same as peaches, without paring.

*Crab Apples*.—Take ripe crab apples; wash, place in kettle and cover with boiling water; simmer until skin comes off readily; then drain off water and remove peel; with a small-bladed knife cut out core from blossom end; do not remove stem; for each one hundred pounds prepared apples take 50 pints water and 125 pounds sugar; place in kettle, bring to a boil; then drop in apples and cook slowly until syrup marks 33 degrees.

*Blackberries*.—Cap the berries and wash if necessary; place in kettle with an equal weight of sugar; turn on steam and cook, without stirring, until syrup marks 33 degrees.

*Cherries*.—Stem and pit red cherries; add an equal weight of sugar and put in kettle with the juice saved while pitting; cook until syrup marks 33 degrees.

*Citron, Domestic*.—Prepare same as for candied citron; take of this, as it comes from the alum bath, 100 pounds; cover with 12½ gallons 25-degree syrup and cook down to 33 degrees; add the juice and yellow rind from two dozen lemons and one-quarter pound thinly-sliced green ginger root.

*Damsons*.—Same as plums.

*Dewberries*.—Same as blackberries.

*Gooseberries, Green*.—Run through a dry fruit cleaner and blow out chaff leaves. To each 100 pounds add 125 pounds sugar and 5 gallons water; cook slowly until syrup marks 32 degrees.

*Gooseberries, Ripe*.—Blow out chaff and leaves, and for each 100 pounds add 100 pounds sugar and four gallons water. Cook slowly until syrup marks 33 degrees.

*Nectarines*.—Same as peaches.

*Peaches*—Cut in halves, remove stone, pare and cut into pieces of desired size; to each 100 pounds add 100 pounds sugar and one-half gallon water (or more if peaches are hard and dry); turn on steam and cook until syrup marks 33 degrees.

*Pears*—Select hard pears, peel, cut in quarters or eighths; remove stem and core; place in kettle; cover with cold water, and cook until tender; then add 100 pounds sugar for each 100 pounds pears; add to kettle and cook until syrup marks 33 degrees. Cook soft pears same as peaches.

*Pineapple*—Peel, cut out all eyes and cores, cut pieces of desired size; place in kettle with equal weight of sugar, and cook very slowly until syrup marks 33 degrees.

*Plums, Damsons, Gages, etc.*—Stem; place in kettle and for each 100 pounds add 100 pounds sugar and two and-half gallons water; cook until syrup marks 32 degrees.

*Quinces*—Select ripe quinces; pare, core and cut into pieces of suitable size; place in kettle and cover with cold water; bring to a boil; then draw off water, cover again with cold water, and bring to a boil; then proceed as above directed and cook syrup to 33 degrees.

*Raspberries*—Cap and clean the berries; place in kettle with an equal quantity of sugar; bring slowly to a boil, and cook syrup to 33 degrees.

*Strawberries*—Same as raspberries.

*Tomatoes, Green*—One hundred pounds green tomatoes; three dozen lemons; 50 pounds sugar; one-half pound green ginger root. Slice the tomatoes, slice the lemons and remove seed; slice the ginger thinly; place the water in kettle and add all the other ingredients; turn on steam and cook slowly until syrup marks 32 degrees.

*Tomatoes, Ripe*—One hundred pounds ripe tomatoes, two dozen lemons; 100 pounds sugar, one-half pound ginger root. Select very small, firm, ripe tomatoes; scald and peel; slice the lemons and remove seed; slice the ginger thinly; place all in kettle, and cook gently until syrup marks 33 degrees.

*Tomatoes, Yellow*—Same as ripe tomatoes.

*Watermelon Rind*—Same as citron.

## APPLE JUICE.

*Apple Juice* is "the thickener" used to improve the consistency and reduce the cost of pure sugar and fruit goods, and with an admixture of glucose is the base of all "compound" jams, jellies and preserves. Under normal conditions it is obtained most cheaply from dried or evaporated skins and cores, turned out as a by-product by nearly all concerns evaporating apples, and is termed "apple waste"



or simply "waste." As a rule, the further north, or the greater the altitude in which the apples are grown, the greater the jelling power they possess. Sour or tart varieties of apples, harvested before they are entirely ripe, contain this principle in a more readily available state to a greater extent than sweet apples. Juice made from the waste of sweet or over-ripe fruit may be improved or developed to a certain extent by adding, in the kettle when boiling down, a small quantity of jelling acid, or old jelly. The lighter and brighter the waste, the lighter and brighter the resulting product. The finer and firmer the flesh of the waste, the clearer will be the product. In purchasing waste preference should be given to that recently made and containing a fair proportion of peelings from light-colored varieties of apples; the cores and the flesh side of the skin to be as little discolored as possible and altogether presenting a bright, clean appearance. When a portion of waste is soaked in cold water for a period of 12 hours the pulp should remain firm, and not become soft and mushy. A little experience will enable one to distinguish the difference between waste made from properly ripened and that from over-ripe fruit. It is very difficult, if not impossible, to economically make clear, brittle, sharp-breaking jelly from over-ripe waste.

When waste is received at the factory sample it thoroughly and if it does not run with a reasonable degree of uniformity either remove it from the packages and mix, or the packages containing the same grades be placed together and the cooker be charged with the different lots in proportion; do this in order to have the juice run uniformly as long a time as possible.

When installing a plant it is advisable to provide cookers and press rather in excess of the proposed capacity of the plant; the initial cost is but little more, and, if at any time found necessary, the setting up of additional kettles will greatly increase the output without the delay and extra cost involved in replacing the press and cookers.

*Cooking*—There are various methods of cooking waste, among which may be mentioned the diffusion process, a modification of the method used to extract sugar from cane and beets. This produces a fine juice, but is a complicated process requiring cumbersome and costly apparatus with close attention to make it at all successful. Vacuum pans, while they turn out a good, clear juice and do not occupy so much room, are also costly and require skilled attention. The steam percolation system, whereby the soaked waste is placed in a conical copper percolator and the juice forced out under steam pressure, is open to objection on account of cost and the danger of waste, depending on the style of cooker and the use to which is quite likely to happen if the operator gets in a hurry. Probably the best method is the one employing a cylindrical horizontal, copper boiler, slightly elevated at one end (say 1 ft. for a 6-ft. boiler) and

containing perforated pipes inside to admit steam; at the lower, or discharge end, place a 4-in. quick discharge valve at the lowest point, and at the top of the highest end place a large man-hole with cover and clamps similar to a retort. A safety valve set at 10 lbs. must also be attached, and this pressure never exceeded. The process usually adopted is the open tank system where the waste is cooked with either open or closed coils in the bottom of wooden tanks. The closed coils will turn out a clearer juice than perforated coils, but are somewhat slower. Whichever system is adopted it is advisable to have two cookers, each with sufficient capacity to load the press, this being far preferable to one large cooker. There is always a difference in the jelling power and clearness of the juice which drains away and that which comes under pressure, and if possible the entire pressing should be run into the juice tank before any is drawn in the kettles. The amount of water used in cooking waste may be varied from one gallon to one-half gallon per pound of waste, depending on the style of cooker and the use to which the juice is to be put. Of course, the larger the amount of water, the more thoroughly the waste is exhausted and the easier to run out of the cooking tank on press, but this is counterbalanced by the extra time and steam required to reduce the juice to the jelling point. The proportions generally employed in the open tank with closed coil is a charge of 100 lbs. waste to 100 gals. water; with open tank and perforated pipes is 100 lbs. waste to 80 or 90 gals. water, depending on the temperature of the water, the idea being to finish the cook by having 1 lb. waste to 1 gal. water; place the waste in the cooker and add the requisite amount of water, allow to soak for the longest convenient period, then crack steam valve so it will heat up very slowly; when hot turn on full steam pressure and bring to a violent boil; cook for one hour, after which turn off steam and press. When the closed boiler is employed, use 200 lbs. waste to 100 gals. water; place waste in, then add the water and soak; bolt down man-hole, turn on steam and bring gradually to a pressure of 10 lbs. and hold there for 45 to 60 minutes. When the cookers are charged and allowed to soak over night, or for several hours, a less period of boiling may be given, cooking until the skins and pulp are thoroughly softened and done, but not cooked to a mush. For fine, light-colored goods, if you have no juice made from fresh stock or apples, make juice by the same process from evaporated apples, chops or cuts if they can be procured.

When procurable, fresh raw waste as it comes from the machine replaces evaporated stock may be cooked in the same manner, though barely cover with water when cooked with closed coils and very little, or none at all, when cooked with open coils. When sound apples or windfalls can be procured at a nominal cost they may be chopped and treated same as fresh raw waste.



Any desired style of press may be used, knuckle joint, four screw or hydraulic, as preferred. Use cheese frames not more than 3 to 4 in. deep. After placing rack and frame, wet the cloth, spread and carefully fit to the bottom and corners; distribute the cooked waste evenly and fill all corners; fold cloth, pin, remove frame and place next rack, and continue until loaded; the racks and cheeses must be exactly superimposed. When platform is loaded run under follower and apply pressure very slowly, stopping as soon as the juice runs freely; when juice nearly ceases running again apply pressure until it runs freely; then stop, and so continue until the cheese is sufficiently dry. If a very quick and continued pressure be applied, the outside of the cheese is likely to become dry and caked, thus preventing the free exit of moisture from the center; it will also force out more "mush" and consequently make a more cloudy jelly. With two cookers, an average 10 hours' run is eight batches from the two; this allows about an hour's time for each pressing. After juice runs from press strain through cheese cloth or other suitable material. If very muddy run through felt or cotton flannel filters. If necessary to have very clear, clarify with isinglass solution same as soup. The juice may be concentrated to, or near, the jelling point, and set aside for the sediment to subside, then draw or syphon off the clear liquid and filter the remainder, or use it for "butter" jelly.

The storage tank, receiving the juice from the press, should be of sufficient size to hold rather more than the full contents of one of the cookers. During the cooler months of the year there is little danger of fermentation taking place in the storage tank and pipes leading therefrom, though it is advisable to clean everything thoroughly for the Sunday shut-down. During the hot months it is best to use, or at least boil down, all made juice and clean up every night. Fermented juice has very little jelling power and foams badly in the kettle.

It will not be surprising if the use of "apple waste" as now gathered from the apple evaporators is forbidden under the pure food laws in the near future. The reason for this is that much of it is dirty and contains the decayed portions of the apples. If made from clean parings of apples, there should be no objection to its use, provided these parings are cared for in a cleanly manner. Unless this is done, there is great likelihood of "apple waste" being condemned just as is pulp from "skins and cores of tomatoes."

## PURE SUGAR, FRUIT AND APPLE JUICE PRESERVES.

Follow general method for hot process preserves, *using juice from press.*

Place the fruit in kettle, and for each 100 lbs. add  $6\frac{1}{4}$  gals. juice; bring to a boil and cook until the liquid marks 8 degrees; then add the sugar and cook until syrup marks 6 degrees less than degree called for by hot process; turn off steam, and after all other ingredients are in add  $1\frac{1}{2}$  pints Tartaric acid coagulant.

*Using concentrated juice,* make same as hot process, cooking syrup to 6 degrees less than called for above. For each 100 lbs. fruit add 2 gals. concentrated juice and set with  $1\frac{1}{2}$  pints tartaric acid coagulant.

*Using jelly,* make same as hot process, cooking syrup to same degree. In a separate kettle make a 28-degree sugar and juice jelly, and mix with the pure sugar goods in desired proportion. For each 60 lbs. jelly used add  $\frac{3}{4}$  pint tartaric acid coagulant.

## COMPOUND PRESERVES.

*Sugar, Glucose and Fruit*—To any of the pure sugar and fruit preserves add, in kettle after goods are finished and steam shut off, or with the syrup in candied fruits, the desired amount of 42-degree glucose. This may be added in addition to the sugar or may be substituted therefor pound for pound.

*Sugar, Glucose and Fruit with Apple Juice from press, from fresh or canned fruit,* following process for pure sugar and fruit with apple juice from press, of which this is an example:

- 100 lbs. Fruit.
- $6\frac{1}{4}$  gals. Apple Juice.
- 50 lbs. Sugar.
- 50 lbs. Glucose.
- $1\frac{1}{2}$  pints Tartaric Acid Coagulant.
- 4 oz. Preservative.
- Color, sufficient.

Place the fruit in kettle, add the apple juice, cook to 8 degrees, add sugar and cook until syrup marks 6 degrees less than called for by hot process; turn off steam; add the glucose, color and preservative, then add the coagulant.



*Using Concentrated Juice*—Make same as hot process, using but one-half the sugar and cooking to 6 degrees less; then add the glucose, concentrated juice, etc., in order.

*Using Jelly*—Make same as hot process with one-half the sugar. In a separate kettle make 28-degree glucose jelly and add in desired proportion, set with tartaric acid coagulant.

*From Hot Process Pure Sugar and Fruit, stored in bulk, using juice from press.*

- 100 lbs. Pure Sugar Preserve.
- 6¼ gals. Apple Juice.
- 50 lbs. Glucose.
- 1½ pints Tartaric Acid Coagulant.
- 3 oz. Preservative.

Place juice in kettle, add the preserves, cook syrup to 6 degrees less than directed in hot process, turn off steam, add glucose, preservative, color and coagulant.

*Using Jelly*—Place the sugar preserves in kettle, heat gently and mix with desired proportion of glucose jelly made in separate kettle; add preservative, color and coagulant.



# JAMS

The war caused the Army and Navy to be the greatest buyers of jams, jellies, etc., ever known. They found standards badly confused, and therefore set about establishing some definite forms. For this purpose they put the leading experts to work, with this result:

*Jam, Canned Quality.*—To be made of clean, sound, properly matured fruit and sugar (sucrose) by concentrating the fruit before adding the sugar, or by concentrating the fruit and sugar together so that the finished product shall show not less than nine parts of fruit to eleven parts of sugar; the fruit to be more or less broken or comminuted and suspended in a semi-solid or gelatinous matrix. Spices or flavoring may or may not be added. Jam having a thick, heavy body on the order of a jelly is preferred to that type which more closely approaches a preserve. Jams made from dried fruits or stiffened with pectin are not acceptable.

The jam shall take its name from the fruit used, or, in the case of a mixture of fruits, the names shall appear in the order of the higher proportion used. The product shall conform to the rules and regulations of the U. S. Department of Agriculture.

If packed in No. 2 cans and in the case of berries or colored fruits, the cans shall be enamel lined, net weight not less than 1 pound 9 ounces.

---

For making jams from fresh fruit in a large way an economical outfit is composed of a series of barrels, elevated on a platform, each containing a large draw-off valve and copper coils in the bottom; the steam pipes are so arranged that the exhaust from the first coil discharges into the second coil, and so on through the series; a steam pipe is connected and carried around the outside of each barrel with valves so placed that one or more barrels may be cut out at any time without interfering with the rest of the series. This system is best adapted to straight sugar, or sugar and glucose goods. If it is desired to use apple juice, concentrate in a jacket kettle before adding.

*American Style, Whole Fruit Jam.*—The consistency of jams should be viscid rather than jellylike. For sugar, fruit and glucose, and for pure sugar and fruit the corresponding grades of preserves are generally used, though frequently boiled down 1 degree heavier with acetic acid or cream of tartar to prevent crystallization. *Grape jam* is an exception and is made by cooking to consistency 50 lbs. grapes, the juice of 100 lbs. grapes with 25 lbs. sugar and adding 2 oz. preservative.

For sugar, glucose, fruit and apple juice jams, cook same as preserves of like grade, but using double the quantity of juice and no coagulant.



For the cheaper grade of jams dilute hot process preserves with a special 30 to 32 degree jelly made by boiling the glucose down with the juice; if surplus juice, either from can or fruit, is available, substitute it for a part of the apple juice used in making the jelly.

### MARMALADES.

*English Style Jam.*—Make the same as American style but wash and break the fruit by frequent stirring or by passing through a sieve. The canned pulp, as directed under canning, is especially adapted for this class of goods. The following are exceptions to the general rule:

*Grape Marmalade.*—Pulp the grapes, reserving the skins; pass the pulp through a rotary pulper and place with the skins in kettle; for each 100 lbs. add 50 lbs. sugar and cook to consistency, stirring frequently; add 2 oz. preservative to each 100 lbs. of finished goods.

*Orange Marmalade, Sweet.*—Peel the oranges and cut the skin in straws; place in kettle and cover with cold water, bring to a boil and cook until tender, drain off the water; run the pulp through a rotary pulper, add an equal weight of sugar, place in kettle with peel and cook until syrup marks 32 degrees; for each 100 lbs. add 2 gals. concentrated apple juice.

*Orange Marmalade, Bitter.*—Peel bitter oranges and shred the skin, then handle same as above.

### SPICED FRUITS.

*Cherries, Pears, Plums, Quinces, Yellow Tomatoes,* make same as hot process preserves, adding, when sugar is put in kettle, for each 100 lbs. fruit, 20 pints 60-grain vinegar in which has been previously cooked for one hour and then strained out 10 oz. sliced green ginger root, 3 oz. whole cloves, 6 oz. whole allspice, 6 oz. Saigon cinnamon and 2 oz. whole mace.

### FRUITS IN BRANDY.

Take fruit saturated with 30-degree syrup by cold process or with 33 degrees by candied fruit process, drain off all syrup, pack in bottles and cover with brandy. Allow to stand four weeks before marketing.

### FRUITS IN CORDIAL.

Same as above, replacing brandy with cordial.

### CRUSHED FRUITS FOR SODA WATER.

Peel, pit and prepare the fruit, pass through a meat chopper having a perforated plate with medium-sized holes; to each gallon of this add 8 lbs. sugar and 1 oz. Tartaric acid, place in kettle, heat to 190 degrees and stir until sugar is dissolved; to each 3 gallons of

this add 2 oz. Japanese gelatin which has been soaked 6 hours in cold water and then dissolved by heat in a little water; stir well together (add color to produce desired shade and to each 100 lbs. of the product add 1 6-10 oz. preservative). The cost may be reduced by replacing a part of the sugar with glucose.

### FRUIT BUTTERS.

Cook fruit butters in a kettle provided with a mechanical stirrer and having a close-fitting lid with shaft to carry off steam.

*Apple Butter, Genuine.*—Take cider fresh from the press and boil down one-half; place in kettle and for every 8 gallons add 1 bushel pared and cored apples, turn on steam and start stirrer, cook until a heavy, dark brown paste results, then add, for each 100 lbs.,  $\frac{1}{2}$  lb. ground Saigon cinnamon and  $\frac{1}{4}$  lb. powdered nutmegs. No sugar is necessary. Finish by passing through a pulper fitted with a fine perforated metal screen.

*Apple Butter.*—Cook in water, or steam, apples until soft, pass through pulper and place in kettle; turn on steam and cook until an almost solid paste results; then for each 100 lbs. add  $\frac{1}{2}$  lb. ground Saigon cinnamon,  $\frac{1}{4}$  lb. powdered cloves,  $\frac{1}{4}$  lb. powdered mace, 15 lbs. sugar and 35 lbs. glucose; when mixed and dissolved turn off steam and add 1 6-10th ozs. preservative. If color is not dark enough add caramel to darken. Finish in pulper.

*Apple Butter from Dried Apples.*—Place the apples in a tank with closed steam coil, cover with twice their weight of cold water and soak 6 hours, turn on steam and cook until soft, run through pulper and place in kettle; cook until nearly a solid paste; then for each 100 lbs. add  $\frac{3}{4}$  lb. powdered cinnamon,  $\frac{1}{2}$  lb. powdered cloves,  $\frac{1}{2}$  lb. powdered Tartaric acid, 15 lbs. sugar, 35 lbs. glucose, and after dissolved and steam turned off add 1 6-10 ozs. preservative.

*Peach Butter, Pure.*—Take ripe or over-ripe, but not decayed fruit, remove stones and run through pulper, place in kettle, and for each 100 lbs. add 50 lbs. sugar, cook to a thick paste, and finish in pulper.

*Peach Butter.*—Make same as above, using a proportion of apples and sweetening with 15 lbs. sugar and 35 lbs. glucose.

*Peach Butter from Dried Fruit.*—Prepare pulp same as dried apples, cook same as peach butter.

*Pear Butter.*—Make same as apple butter, using no spice.

*Plum Butter.*—Run through pulper and cook same as peach butter.

*Tomato Butter.*—One hundred lbs. tomatoes, 25 lbs. apple pulp, 40 lbs. sugar,  $\frac{1}{4}$  lb. Tartaric acid, 3 ozs. powdered ginger. Scald, peel and core the tomatoes; place tomatoes and apple pulp in kettle and cook to a stiff paste; then add the sugar and ginger, stir until dissolved, shut off steam and add preservative. Do not run this through a finishing machine; allow the seed to remain in the goods.



# JELLIES

The U. S. Food Standards are:

Jelly is the sound, semi-solid genatinous product made by boiling clean, sound, properly matured and prepared fresh fruit with water, concentrating the expressed and strained juice, to which sugar (sucrose) is added and conforms in name to the fruit used in its preparation.

Glucose jelly is a jelly in which a glucose product is used in place of sugar (sucrose).

---

Use wide, shallow jacketed kettles instead of the narrow, deep kettles, which are better suited to cooking than fast evaporation.

Do not process jelly of any grade.

Cover the surface of jelly in packages with parchment paper moistened with a solution of preservative, or with anti-mould.

## ANTI-MOULD FOR PRESERVES.

Dip parchment discs in 95 degrees alcohol.

If circumstances allow, do not cap tumbler goods until quite cold. If capped while hot, moisture condenses between the jelly and the cover and favors the formation of mould.

Do not ship pail jelly until cold all through; if carefully handled they may be headed and stacked in 2 or 3 hours if necessary.

## COAGULANTS OR JELLING ACIDS.

The jelling principle of all fruits is more plentiful in ripe fruits than in unripe fruits, as a portion of it undergoes a chemical change during the ripening. In its natural state it is freely soluble in hot and boiling water, and in combination with sugar or glucose in hot solution; on cooling it holds, or sets, the water forming a jelly; this is readily soluble in an excess of water; if melted and boiled for a time a chemical change similar to that in the ripening of fruit takes place, and a syrup liquid results. In combination with sugar or glucose and an excess of strong vegetable acid it sets in much less time and in much hotter solution. This jelly is soluble in water. In combination with sugar or glucose and a mineral acid it becomes insoluble and sets almost immediately even when in a very hot solution. This jelly is practically insoluble in water and when remelted will not set again. Owing to the insoluble substance formed on contact with mineral acid it will hold much water without parting with it ("bleeding" or "weeping") than when in its natural state, or with vegetable acids.

Use the following coagulants in proportion of  $\frac{3}{4}$  pint to 30-lb. pail for hard jelly, or a half pint to a 30-lb. pail for a soft-spreading jelly.

*Tartaric Acid Coagulant.*—Six lbs. Tartaric acid,  $1\frac{1}{2}$  gals. water. Mix and dissolve.

Acid phosphate, made by soaking good, clean bones in diluted sulphuric acid, may also be used in same proportion.

## PECTIN.

In view of the fact that success in the manufacture of jellies and jam is largely dependent upon the amount of pectin which is present in the fruit, it is deemed advisable to describe briefly the nature of this product as it relates to the manufacturer of jellies and jams, and also to set forth briefly the method of manufacture of the so-called Pectin Syrup, which is now being used largely in the manufacture of these products.

Pectins are closely related to gums and mucilage and, like those substances, are widely distributed in nature. Pectin is found among the most commonly known fruits, and in large percentages in apples, pears, oranges, grapes and other fruits; it also occurs in carrots, beets, and some of the other root bulbs.

Pectin, as such, occurs only in ripe fruit, contrary to the opinion usually held by many people, and not to any appreciative degree in unripe fruit. Growing and partially ripened fruit contain a large amount of insoluble pectose bodies and an enzyme, pectase. As the fruit proceeds to ripen, the pectase acts upon the pectose, forming the soluble pectin. The greatest percentage of pectin in fruit occurs when it is just ripe. It must be remembered that when fruit juice is boiled too long the pectin undergoes a change and loses its power of gelatinizing, owing to the fact that it becomes converted into pectic and other acids. It must be also remembered that the pectose which, as stated, occurs in unripe fruit may be converted into pectin by the application of heat, and it is for this reason that statements have been frequently published that pectin occurs mostly in unripe fruit. It is produced from the unripe fruits by the process of cooking.

While most fruits contain pectin, it is most readily available at a low price in apples. For this reason the plan of cooking apples with other fruits has been used for a long time to produce the usual factory type of apple and fruit jellies and jams.

The use of any pectin in addition to that already present in the fruit is not a proper procedure in the manufacture of pure fruit jellies, jams or preserves. If it is to be used to any extent, the presence of its addition should be clearly stated upon the label.

Pectin or pectin syrup is largely used at the present time by many manufacturers in the production of compound fruit and apple



base jellies, jams and preserves, and also in different compounds containing glucose. When properly used and declared on the label in accordance with the law, no objection can be raised, and it is recommended and believed that the proper use of pectin in these products is legitimate and also an advantage in many cases.

### *The Manufacture of Pectin Syrup.*

Pectin syrup can be manufactured from many fruits. The usual commercial method of manufacture, however, is as follows:

Apple waste, apple chops or fresh apple pomace are used. In all cases the material is first extracted for all available cider for the manufacture of vinegar, after which the fruit taken from the press, and usually designated at that time as the "cheese" or "press cake," is placed in wooden tanks and about three pounds of water added for each pound of "cheese." This mixture of apple and water is then cooked with live steam at 70 to 80 pounds pressure for about 30 minutes. In some cases it is advisable to add enough citric or tartaric acid to produce .3 per cent. of the same in finished product. After cooking the mass is pressed in regular cider presses, the liquor then transferred to settling tanks and allowed to precipitate for two or three days. The liquor is then treated with diastase to remove the starches, which process prevents the later precipitation of starch tanniate, which occurs in the finished product if this step is not taken. This step takes not to exceed 24 hours, after which the liquor is filtered through pulp filters of the usual vinegar type and the clear liquor thus obtained is reduced to a syrup by any approved form of vacuum evaporator. One method of doing this is by use of "Yaryan" vacuum cooker equipped with aluminum tubes. This apparatus works usually under about 20 inches vacuum and 12 pounds steam pressure. The finished product will come from this machine at about 165 degrees Fahrenheit, and may be filled hot into five-gallon lacquered cans and stored until used.

As the percentage of pectin will vary in fruits, the reduction of any stated volume of solution obtained, as described, to any stated gravity will not be uniform in its jelling power. For this reason the use of a finished product thus made in accordance with a set formula would not be entirely trustworthy as to producing definite results. This fault may be remedied by testing the filtered solution before evaporating to determine its jelling power. After having made this determination, it will be found easy to regulate the degree of concentration of the finished product to a point whereby a definite jelling factor may be obtained, and in this manner a uniform finished product can be obtained at all times. It must not be expected that the specific gravity or the degree of concentration will be the same in different batches, for it will not.

The percentage of pectin syrup to be used in different grades of jelly, jam, etc., will vary with the practices in different factories.

A formula to start with would be about as follows:

- 15 lbs. Fruit Juice.
- 10 lbs. Pectin Syrup.
- 60 lbs. Sugar.
- 16 lbs. Water.

Allow 6 lbs. for evaporation in cooking, and 95 lbs. of jelly will result.

### PURE SUGAR JELLIES.

*Apple Jelly.*—Take juice made from entire apples; if not perfectly clear, pass through felt filters; place in kettle and bring to a boil; skim off all froth; add an equal weight of sugar (or 8 pounds per gallon), stir until dissolved; then boil continuously until it jells, which under normal conditions will be at about 32 degrees; keep well skimmed all the time; judge by placing a few drops on a cold surface, or by its drop from paddle. When sugar is first dissolved it will run syrupy from a paddle; at the next stage will “string,” and at the next stage break from the paddle in drops. If desired, a small proportion of tartaric acid coagulant may be added. Fill in tumblers and set aside to cool.

*Cider Jelly.*—Cider jelly is best made in a continuous evaporator built especially for the purpose. Take cider immediately from the press, bring to a boil, skim and filter; then evaporate until it jellies, which ranges from 28 to 34 degrees. Cider from tart apples will give the finest jelly; one pound of sugar to the gallon may be added.

*Crab Apple Jelly.*—Wash and chop the apples; allow 2½ gallons water to each 100 pounds; make juice, and handle same as apples.

*Blackberry Jelly.*—Put berries in kettle with a very little apple juice; heat slowly until berries are soft; express juice and filter; then finish same as apple jelly.

*Cherry Jelly.*—Use pie or morello cherries, and make same as blackberry jelly.

*Cranberry Jelly.* Place 100 pounds cranberries in kettle with 6¼ gallons apple juice; bring to a boil and cook 10 minutes; express juice and place in kettle with 50 pounds sugar; finish same as apple jelly.

*Currant Jelly.*—Select under-ripe currants, express juice, and filter through canton flannel, without squeezing; place in kettle and finish same as apple jelly.

*Damson Jelly.*—Make same as blackberry jelly.

*Grape Jelly.*—Make same as blackberry.

*Green Grape Jelly.*—Stem the grapes, make juice and finish same as apple jelly.



*Pear Jelly.*—Make juice same as apple, and finish same as apple.

*Peach Jelly.*—Stone the peaches, add a very little apple juice and a few peach kernels (or a drop or two Ext. Bitter Almonds), place in kettle and cook until soft; finish same as blackberry.

*Pineapple Jelly.*—Make juice same as currant, and finish same way.

*Plum Jelly.*—Same as blackberry.

*Quince Jelly.*—Core the quinces, or cut and remove seed; make juice and finish same as apple.

If quinces are treated as elsewhere directed, utilize the water in which they were boiled and the peelings and cores, with all seeds removed, for jelly, handling exactly as raw apple waste.

*Raspberry Jelly.*—Same as blackberry.

*Strawberry Jelly.*—Same as blackberry.

Pure sugar jellies may also be made by placing the sugar with a very little water in a pan over open fire, and cooking the syrup to the "ball" or "crack" degree; then add the fruit juice and finish in the regular way.

## GLUCOSE AND APPLE JUICE JELLY.

In the preserving line the articles having the largest sale, and generally returning the least profit, are the imitation fruit, or glucose and apple juice jellies, which occupy about the same position with the preserver that sugars do with the grocer.

Whenever the building will allow, the gravity system should be adopted, so that water and waste may be started at the top and finished jelly be drawn at the bottom without the intervention of a pump or the handling of glucose. This system will occupy a portion of 2 or 4 floors, according to the height of ceilings, and is arranged with cookers above the load height of the press (the press being on same floor with the glucose tank, if glucose is pumped, or with the glucose skids if barreled glucose is used); below the press is the juice storage tank, with pipes leading to the kettles, and below the kettles either a tank to receive the mixed jelly from kettle, if it is mixed in the same kettle in which juice is boiled down, or a tank, containing a mechanical stirrer, in which to mix the glucose and concentrated juice. The jelly should not be filled into packages from the kettle, but be drawn off into another receptacle, from where it can be filled while another batch of juice is being reduced in kettle. Fill the kettle just above the jacket and apply the full steam pressure (see note\*); so soon as the foam is "killed," using olive oil if necessary, and the

---

\*Note.—Steam pressure should be 70 to 80 lbs. for reducing juice. Never concentrate juice with a fast-falling steam pressure; in order to get results pressure must be constant or rising.

juice has the proper "throw," open the valve of the supply pipe and allow the juice to run in, so slowly that the boil is not materially checked, until the kettle is sufficiently charged. Little time is gained by overloading, about three-quarters full usually giving the best results. When the juice is boiled down to about three-fourths of its bulk, gauge the quantity and take the gravity with a syrup hydrometer, carefully recording both results; at the same time mix four ounces, or other convenient quantity, of the juice with an equal quantity of glucose, and another portion with twice its bulk of glucose; cast both in tumblers with your regular coagulant. Proceed in this manner every few minutes, noting quantity in kettle and gravity and casting samples until the hydrometer marks 14 degrees. From these samples of jelly it can be easily determined which is the best jelling fruit with both proportions of glucose; also which particular mixture and gravity will make the most satisfactory hard jelly for the grocery trade, and which the soft for bakers. These points decided, so long as the juice runs uniformly the jelly may be made without using the hydrometer by placing in the kettle each time the same amount of raw juice and boiling it down to a certain bulk, which will be determined by the gauge stick. In selecting soft jelly care must be taken that the first jelling point is not too closely approached. It frequently happens that jelly made in the winter, or during the cooler months, which apparently sets perfectly and is quite hard enough for shipment, will turn syrupy when stored in a warm place, or when subjected to summer heat. Jelly which has turned in this manner cannot be reclaimed in bulk with apple juice, but must be worked into fresh jelly by mixing in small quantities at a time.

When, instead of a sharp-breaking, brittle jelly, nothing can be produced but a tough, stringy, tenaceous mass, it indicates that the juice has been boiled down too hard, too much glucose used, or sweet or over-ripe waste. When it breaks properly but cannot be made hard enough, it indicates not enough glucose, poor waste, or waste not sufficiently exhausted in cooking. In the case of sweet waste this can sometimes be overcome by boiling the juice down with a little syrupy jelly or coagulant. Should this fail, make juice with one part of this waste to three parts of a good sour waste. Owing to the varying amounts of sugar and gummy matter contained in the skins, no hydrometer or no simple chemical test will give the jelling power of juice; it must be tried practically.

After the juice has been concentrated to the proper density, turn off the steam, add the required amount of glucose and mix thoroughly; then add the color, preservative and flavor if used.

Never heat glucose to the boiling point if it can be conveniently avoided. Much of the glucose contains a certain amount of free acid, and boiling may cause this to split up, a portion of it forming



sulphuretted hydrogen in the goods, which will completely ruin them for all purposes.

To cast jelly in pails, first rinse the pails with cold water, then place the required amount of coagulant therein and set on a perfectly level floor or platform. Draw off in a bucket or measure just sufficient jelly to fill a pail; pour in as rapidly as possible, without splashing, and at the same time, with a large spoon, stir first with a circular and then a circular up-and-down motion from the bottom; just before the jelly sets hold the spoon on the surface to collect the small bubbles and remove them. Tumblers and small pails may be filled by diluting the coagulant with an equal bulk of water and pouring in the jelly with a rush to thoroughly mix the two. Tumblers may be filled from a measure or vessel having a lip or spout by mixing a smaller proportion of Tartaric acid coagulant with the jelly and pouring quickly before it sets. It must be, however, remembered that while the primary object of the coagulator is to make the jelly set quickly, it also prevents the finished article from "bleeding" or "weeping," and if too small a proportion is used there will be trouble from this. Care must be exercised that the coagulant is thoroughly mixed with the jelly and none allowed to float on the top.

It is the practice in nearly all factories with jellies of this grade to use no flavoring and no coloring for the light varieties, and but one shade of red for the dark kinds.

It is, however, advisable for the tumbler goods and a better grade of pail goods to either boil down with the apple juice some of the genuine fruit juice or to use a very small quantity, say  $\frac{1}{8}$  oz. to 100 lbs., of the appropriate ethereal flavor; also to use the proper coloring for each variety.

When a tough, spreading jelly is required for special purposes, it may be made by boiling down the proper amounts of glucose and juice together, previously testing the glucose for free acid. It is, of course, necessary to know the jelling strength of the apple juice, and this can be ascertained by making jelly from it in the regular way and taking the density with hydrometer; then boil the mixed glucose and juice to correspond.

*Sugar and Glucose Imitation Jellies.*—Make same as glucose jellies, substituting the desired proportion of sugar for glucose.

*Sugar and Glucose Jellies.*—Make same as pure sugar jellies, substituting for the sugar the desired amount of glucose. For a cheaper grade use apple juice in all the pure jellies.

## FRUIT JUICES

Make the juice same as if for jelly, but using no apple juice; it may be filtered clear, or clarified and boiled with isinglass; or may be merely strained and left cloudy, as desired. It may be preserved in barrels, same as apple juice, or sterilized same as directed for grape juice. These juices are also put up in quart champagne bot-

tles for soda fountain use, either with preservative or by placing the hot juice in bottles, sealing and processing 45 minutes at 212 degrees.

If the fruit is cleaned previous to pressing, the pomace may be pulped and used as a filling for low-grade jams or butters.

### GRAPE JUICE.

Is used principally as a beverage. Select Concord grapes, crush between corrugated rollers set just far enough apart to avoid crushing the seed; place on press and express juice in the same manner as for apples; place the juice immediately in a kettle and heat to 190 degrees, then fill in 5-gal. glass demijohns which have been sterilized in a steam box, cork and place on racks in a dark cellar. The cork should be covered with a circle of raw cotton (cut with a die from ordinary cotton batting) and this in turn with a smaller circle of pure tin foil; force the cork in until the foil is below the lip of 'john. After standing for greater or less length of time the sediment in the juice will subside, and when the line of demarcation is sharply defined the clear liquid may be syphoned off, placed in kettle, with sugar and water added if desired, and brought slowly to a temperature of 180 degrees; then place in bottles for sale, sterilizing half-pints 45 minutes, pints 60 minutes and quarts 75 minutes at 190 degrees. Put the sediment remaining in kettle, heat to 190 degrees, and fill the 'johns full, corking as at first. Continue this operation as the juice separates until finally a nearly solid mass, containing a large proportion of crude cream of tartar or argols, remains. Press and dry this and sell to a manufacturing chemist.

### CORDIALS.

*Curacoa Cordial.*—One pound outside yellow rind of orange, one-half pound ground bitter orange peel, one-half ounce ground Saigon cinnamon, one-quarter ounce nutmegs, two gallons 95 per cent. alcohol. Soak two weeks; filter off liquid and add to it seven and one-half pounds of sugar dissolved in one-half gallon of water. Add a trifle of blood orange color to tint if necessary.

*Maraschino Cordial.*—Twenty-nine gallons 95 per cent. alcohol, two drams extract bitter almond, one-half pint raspberry syrup, one-half pint orange flower water (Chiris), seven and one-half pounds sugar, one-half gallon water.

Mix alcohol and extract bitter almond; dissolve sugar in water; add orange flower water and raspberry syrup; then mix all together.

### PUDDINGS.

*Plum Pudding, Fancy Grade.*—Twenty pounds currants, twenty pounds seeded Muscatel raisins, twenty pounds suet, fifteen pounds bread crumbs, five pounds sugar, two pounds candied lemon peel,



five pounds candied orange peel, five pounds flour, one-quarter pound of powdered nutmegs, eight dozen eggs, six gallons brandy. Dry clean the currants; clean and chop suet fine; chop orange and lemon peel very fine; mix all dry ingredients together; beat the eggs and mix with the brandy; then mix thoroughly with other ingredients; pack in cans, cap, tip and process; quarter-pound cans, one and one-half hours at 240 degrees; one-half pound cans, two hours at 240 degrees; one-pound cans, two and one-half hours at 240 degrees; two-pound cans, three hours at 240 degrees; four-pound cans, four hours at 240 degrees. The brandy may be replaced by three gallons alcohol, one gallon fruit juice and two gallons water, mixed.

*Plum Pudding, Choice.*—Fifteen pounds bread crumbs, five pounds flour, ten pounds seeded Muscatel raisins, two pounds candied lemon peel, two and one-half ounces Tartaric acid, ten pounds currants (dry cleaned), ten pounds brown sugar, two ounces powdered Saigon cinamon, one ounce powdered nutmegs, ten pints molasses, two and one-half dozen eggs, ten pounds chopped suet, one and one-half ounces baking soda.

Mix well all dry ingredients except Tartaric acid and soda. Dissolve the acid in a little water and mix with the molasses; beat eggs and add to molasses; dissolve the soda in one-half pint of boiling water and mix with the molasses; add to dry ingredients and make a paste; pack in cans, cap, tip and process same as above.

*Plum Pudding.*—Twenty pounds suet, twenty pounds currants, sixteen pounds flour, ten pounds bread crumbs, twenty pints molasses, five ounces tartaric acid, twenty pints apple pulp, one-half pound salt, four ounces ground Saigon cinnamon, four ounces baking soda.

Add the tartaric acid and apple pulp to the molasses, then the soda, and make a paste with the other ingredients previously mixed.

*Rice Pudding.*—Fifteen pounds rice, fifteen pounds sugar, ten pounds raisins, forty gallons milk.

Clean and seed raisins; wash the rice with cold water; place the milk in kettle, add half the rice and cook thirty minutes; then add balance of rice and cook thirty minutes; divide the raisins among the cans, fill with the cooked rice, cap, tip and process; three-pound cans, fifty-five minutes at 250 degrees.

*Fruit Pudding.*—Twenty pounds corn starch, forty pounds sugar, five pounds dried fruit, three-quarters of a pound salt.

Cover the fruit with cold water and soak six to eight hours; drain off water and run through pulping machine; then mix with the corn starch; then add the sugar and salt and thoroughly incorporate; spread the resulting mixture on trays and place in drying room; when dry reduce to a powder and pack in boxes.

Twenty pounds tapioca may be substituted for the corn starch, and fifteen pounds of fresh or canned fruit drained free from juice

may be substituted for the dried fruit; the powder may be made into a mass with glucose and packed same as condensed mince meat.

### MINCE MEAT.

It is not advisable to process mince meat, as the suet will separate and form a solid cake when cans cool.

If the mince meat is prepared with 1 6-10th ozs. benzoate soda to each 100 lbs., or sufficient alcohol is used, it may be canned without processing.

Wet mince meat, even of the best quality, when handled in the ordinary commercial way will not keep without the use of preservative. If the use of benzoate is abandoned there appears to be no alternative except the excessive use of alcohol to the extent of at least 6 per cent. for safety. Alcohol 95 per cent., neutral or cologne spirits, brandy, wine, whiskey or rum may be used on this basis; that is, 6 per cent. absolute alcohol.

Use good, tart apples, free from decay; chop moderately fine; if it is desired to have the apples show white in the finished meat, throw in a solution of one ounce sulphite soda to five gallons water as soon as apples are pared, and keep wet with the syrup while chopping; if apples are sweet, add enough tartaric acid to make snappy. Wash and clean the seedless raisins and currants, hand picking to remove stones; clean, stem and seed raisins. Chop the orange and lemon peel very fine, and the citron coarse. Select good, fresh, firm suet; trim out all kernels, meat, bloody parts and the larger strings; chop fine and run through a coarse sieve to remove the small strings. Suet may be thoroughly chilled and run through any of the "plate" choppers (using the small holes), but, while it saves time and suet, the mince meat will not present so fine an appearance. Meat as cooked by many simply forms a tasteless and expensive filling. To cook meat properly it must be first plunged in a *boiling hot* solution of salt (three pounds of salt to twelve and one-half gallons of water), then changed to a 1 per cent. solution, where the cooking is finished; trim out all fat and gristle and chop quite fine.

Meat is seldom used, except in a few special grades. For the cheaper mince meats it is not necessary to either pare or core the apples; core for the medium grades, and both peel and core for the best grades.

A convenient size box is made of two-inch stuff, two inches wide at bottom, two feet eight inches deep, and of any desired length. In mixing always first mix the apples and suet; then spread out over the bottom of box and add the other dry ingredients in even layers; turn over with shovel, add the syrup, turn over again, then allow to soak twenty-four hours, or long enough for the fruit to swell out plump; then mix again and put in packages. If it has to be put in packages without the twenty-four hours' soak, steam the



currants and raisins. If dried or evaporated apples are used, chop very finely and use one pound of apples and two pounds of water for three pounds of raw apples.

Coat all soft-wood packages with melted paraffine wax or shellac varnish. Place a notice on packages requesting the dealer to stir and dip from the bottom every time any of the contents is removed.

*Fancy Mince Meat.*—Twenty pounds cooked beef, forty pounds sultana raisins, one hundred and sixty pounds currants, forty pounds Muscatel raisins, twenty-five pounds suet, twenty pounds citron, ten pounds orange peel, five pounds lemon peel, four hundred and eighty pounds apples (cored and peeled), twenty gallons syrup, six pounds salt, three-quarters of a pound ground Saigon cinnamon, one-half pound ground cloves, one-quarter pound ground nutmegs, two gallons spirits, and one and one-quarter pounds preservative. To cheapen this, add more apples, making no other change than to slightly increase the amount of spice and syrup. Brandy or other spirits may be replaced by alcohol and fruit juice mixture, as for plum pudding.

*Standard Mince Meat.*—Twenty-five pounds sultana raisins, twenty-five pounds Muscatel raisins (seeded), fifteen gallons brown sugar syrup, three pounds salt, three-quarters of a pound Saigon cinnamon, one-quarter of a pound of nutmegs, one gallon spirits, one pound preservative.

*Mince Meat, Second Grade.*—Forty pounds raisins, sixty pounds currants, fifteen pounds suet, four hundred pounds apples, ten gallons molasses, one pound ground cloves, two pounds salt, three-quarters pound preservative.

*Dry or Condensed Mince Meat.*—This is a mixture of dried fruits and spices made into a mass with a paste of flour and molasses, and, unless made in very small batches, requires a power dough machine to properly mix. The composition can be varied nearly as much as the ordinary or wet mince meat, but enough flour must be used to form the mass properly and make the mixture thick enough when it is prepared for pouring in crust. Water may be used to assist in forming the mass, but if any considerable quantity is used it will dry out and leave a hard, solid cake that is not easily managed by the consumer. When properly made it will remain soft and moist for an indefinite time.

In summer, unless placed in cold storage, it is apt to become wormy; this, to a certain extent, can be obviated by thoroughly steaming the currants and raisins before mixing.

Prepare the fruit same as for wet mince meat; steam the currants and raisins; dip the apples momentarily in cold water, and chop very fine. Start the machine and first place therein the sugar, then the flour, followed by all the other dry ingredients; then add the apples and the balance of fruit; when well mixed add the molasses and caramel previously stirred together; after the molasses is in it

will require but a few turns of the arms to make a mass. If it does not, add a very little water (one or two pints to a batch), turn out of machine, form in cakes or bricks, wrap in waxed paper, and place in paper boxes.

*First Grade Dry Mince Meats.*—Eighty pounds dried apples, twenty pounds evaporated apples, twenty pounds Muscatel raisins, ten pounds sultana raisins, fifteen pounds currants, five pounds candied citron, two and one-half pounds orange peel, forty pounds "A" sugar, twenty pounds rye flour, three pounds salt, one and one-half pounds powdered tartaric acid, two pounds powdered Saigon cinnamon, three-quarters pound powdered cloves, one-quarter pound powdered nutmegs, four gallons molasses, four pints caramel.

*Medium Grade Dry Mince Meat.*—Eighty pounds dried apples, ten pounds Muscatel raisins, ten pounds sultana raisins, fifteen pounds currants, two and one-half pounds candied citron, thirty pounds brown sugar, fifteen pounds rye flour, three gallons molasses, three pints caramel, one pound ground Saigon cinnamon, one-half pound ground cloves, two pounds salt, one pound powdered tartaric acid.

*Second Grade Dry Mince Meat.*—One hundred and twenty pounds dried apples, twenty pounds Muscatel raisins, ten pounds currants, forty pounds brown sugar, twenty pounds flour, two gallons molasses, two pounds glucose, one pound ground Saigon cinnamon, one pound ground allspice, five pints caramel, three pounds salt, one and one-half pounds powdered tartaric acid.

## PIE FILLERS.

*Orange Meringue Pie Filler.*—Eighteen gallons water, 25 pounds corn starch, 2 ounces carbonate soda (powdered), 60 pounds sugar, 240 pounds glucose, 6 dozen eggs, 3 dozen oranges, 2 pounds powdered tartaric acid, 4 ounces oil of orange, 4 ounces 95 per cent. alcohol.

Grate off the outside yellow rind of the oranges and mix with the expressed juice; mix the oil of orange and alcohol; beat the eggs. Place the sugar in kettle, having a mechanical stirrer, with the corn starch and carbonate of soda; mix thoroughly; then add the water and 100 pounds of the glucose; turn on a full head of steam and bring to a boil; when the starch "sets" cut steam down and cook five minutes, then shut off the steam and add the beaten eggs; when well mixed add the remainder of the glucose; mix and turn out on cooling table; when temperature has fallen to about 110 degrees add the rind and juice of oranges, the tartaric acid, the mixed oil and alcohol, and thoroughly incorporate; then run in pails and cover surface with parchment paper.

When first made this filler will have a smooth, translucent appearance, but on standing a few days will assume a granular appearance.



Should it separate with age, drain off the syrupy liquid and mix with one-half pound corn starch for each pail, place in kettle and bring to a boil, run the solid portion through a pulper and mix with contents of kettle, place in pails and sell for quick consumption. In making future batches increase your starch by this amount (35 pounds instead of 25 pounds). When you have found a starch that will stand, never change. If using chemicaled starch, do not use the carbonate soda.

It is advisable to do considerable experimental work on pie filler before placing on the market. Obtain several samples of starch and make small batches, one-tenth or one-twentieth of the formulae, using different starches and different proportion; place in pails and set in a warm place for several weeks, examining them frequently and noting appearance. Mark the sample number on side of pail, not on lids, as the lids frequently get misplaced.

Ground dried orange peel, soaked in water, may be used instead of the grated peel from fresh fruit; the mixture may be cooked in a tank with perforated coils by making due allowance for the condensed steam.

*Lemon Meringue Pie Filler.*—Make exactly the same as orange, using the grated orange peel and juice same as for orange, but use oil of lemon instead of oil of orange, and the appropriate lemon yellow color.

*Fruit Meringue Pie Filler.*—Nine gallons canned fruit (juice and all), 9 gallons water, 25 pounds corn starch, 60 pounds sugar, 240 pounds glucose, 6 dozen eggs, 1½ pounds powdered tartaric acid. Mix the sugar and corn starch, add the canned fruit and water with half the glucose, cook same as orange; turn out on cooling table; when cool add the acid.

*Fruit Pie Filler.*—Make a cheap glucose, sugar and apple juice preserve or jam, using tartaric acid coagulant.

*Crystallized Fruit Pie Filler.*—Make same as fruit pudding, and add to it 5 pounds of dried fruit (if apricots, peach, apple, etc., chop moderately coarse), which moisten with heavy syrup; roll in granulated rock candy and dry before mixing with the powder.

*Pumpkin Pie Filler.*—One hundred pounds pumpkin pulp from machine, 10 pounds sugar, 2½ pounds corn starch, 5 pound butter, 1 pound salt, ¼ pound ground mace, ¼ pound ground cinnamon, ½ pound ground ginger, ½ gallon Jamaica rum.

Place the butter in kettle, add the pumpkin, salt and sugar, heat to about 180 degrees, then add the other ingredients mixed with the rum; mix well, place in cans, cap, tip and process: 3-pound cans 20 minutes at 240 degrees.

If to be put in pails, bring to a thorough boil before adding the rum, and add 3 ounces preservative to each 100 pounds.

*Condensed Pumpkin Pie Filler.*—Take pumpkin pulp as it comes from the machine, put on press and express all the liquid

possible. Seventy-five pounds pressed pulp, 10 pounds sugar, 10 pounds flour, 2 pounds salt,  $\frac{1}{4}$  pound ground mace,  $\frac{1}{2}$  pound ground cinnamon,  $\frac{1}{2}$  pound ground ginger, 2 gallons glucose. Place the pumpkin in dough mixer, add all the dry ingredients and mix thoroughly, then add the glucose and make a paste; form in blocks same as dry mince meat.

*Cranberry Sauce.*—One hundred pounds cranberries, 100 pounds sugar, 7 gallons apple juice, 5 to 15 gallons glucose. Place the berries and juice in kettle, bring to a boil and cook ten minutes, then add the sugar and cook 25 to 30 minutes or until syrup jells. Shut off steam and add the desired amount of glucose. All soft wood packages should be coated with shellac or other substance of like nature.

## CATSUPS

### FACTORY CONTROL OF THE COMPOSITION OF TOMATO KETCHUP.

By F. F. FITZGERALD

(Of the National Cannery Association Laboratories.)

The Committee on Standards of the Association of Official Agricultural Chemists has defined ketchup as the clean, sound product made from the prepared pulp of clean, fresh, ripe tomatoes, with spices and with or without sugar and vinegar.

Since ketchup is a condiment, and since the tastes of individuals differ greatly, it is about as difficult to fix a standard for ketchup as for salad dressing, sauces and the like. However, at least partial specifications can and should be established. The character of the material should be clearly defined, and, if the grades are not determined on the basis of solids present, a minimum percentage of tomato solids should be prescribed.

But I desire to discuss, not the standardization of the products or different manufacturers, but the standardization of the brand of product of the individual manufacturer, for there is often a greater difference between the batches run on a single day by an individual ketchup maker than between the product of different manufacturers. Just what are the variations in composition?

The solid matter, or total solids, in ketchup varies from less than 12 per cent. to over 37 per cent. This means that the product varies from a substance having barely sufficient tomato added to give color and taste, to a rich, heavy tomato ketchup. The variation of total solids in any one brand is, of course, less, but large differences are not unusual. Three bottles of one brand showed a solids content varying from 12 per cent. to 16 per cent., and seven of another brand varied from 32 per cent. to 37.2 per cent.

The variation in insoluble solids is comparable from 0.9 per cent. to 2.3 per cent. The ash varies usually from 2 per cent. to 4 per cent., owing to the addition of different amounts of salt. The acidity of ketchup varies from 0.43 per cent. to 2.34 per cent. About half of this acidity is due to the citric acid contained in the tomato, and the remainder to the vinegar added. The variation in the acidity of the same brand is great, four samples showing values of from 0.8 per cent. to 1.35 per cent. The sugar is derived from the sugar in the tomato and the sugar that is added, with the result that the variation in the amount present in the finished ketchup is as great as the variation in acidity.

Usually the ketchup maker adds the same weight of salt, onions and spices to each batch, irrespective of the volume of the finished product that



will be obtained; hence, a uniform product does not result, nor can uniformity be expected by such methods. Moreover, commercial spices are not uniform in quality and the amount of flavor extracted from them in ketchup making varies greatly; no considerable improvement is possible until suitable spice extracts are placed on the market.

It goes without saying that ketchup of uniform color, consistency and taste can be produced only by controlling the quality and quantity of its constituents. Therefore, any satisfactory method of control necessitates the determination of the solids in the batch of cyclone juice before sugar, salt, vinegar and spices are added. Control, based solely on uniform specific gravity of the finished product assures only that the specific gravity is uniform; it does not assure uniformity in consistency, sweetness, acidity or in any other characteristic of ketchup as a condiment.

Uniform quality also demands uniform methods of factory manipulation or practice. If the ketchup maker in one factory breaks the tomatoes by steam, the product will necessarily differ from that obtained in a second factory where a mechanical breaker is employed. The first procedure will give a product with proportionately more body, which is due probably to a higher pectin extraction, but will also entail a sacrifice of color.

Since, under any specific procedure in a factory, the distinctive tomato flavor and the consistency of the finished product depend entirely on the tomato solids, and since about half the final acidity and sugar content is derived from the same source, the control of the tomato solid content is especially important.

Fortunately the solids in cyclone juice have a fairly uniform composition. The ratio of total solids to insoluble solids is fairly constant, likewise the ratio of sugar to acid. The sugar in cyclone juice varies from about 42 per cent. to 54 per cent. of the total solids, averaging about 50 per cent.

Any method of determining the solids in cyclone juice may be used, but the one best adapted for the purpose involves sampling the contents of a tank filled to a definite height with boiling pulp. The cyclone juice may be prepared by any method. The tomatoes may be broken by steam or mechanical breaker, and may be cycloned hot or cold. As soon as the coils of the evaporating tank are covered, the steam should be turned on and the cyclone juice should be run into the tank until the tank is filled to a pre-determined height corresponding to a known volume. Instead of filling the tank to any height and, after the contents boil, turning off the steam and measuring the volume by means of a gauge stick, it is preferable that the tank always be filled to the same height with boiling pulp. This may be accomplished by filling the tank slightly above the mark and evaporating to the desired volume. When this point is reached a sample is taken and strained quickly through a piece of muslin into a No. 3 sanitary can or similar receptacle, which, in turn, is placed in a bucket or larger receptacle containing cold water, preferably ice water. The muslin removes enough of the insoluble solids to permit the use of a Brix hydrometer and the ice water cools it to a temperature below 90 degrees F., which is sufficient to prevent evaporation and permit the use of a correction table for the temperature of the filtrate. After the Brix reading is taken by a suitable hydrometer the temperature is read and the Brix reading corrected for the temperature.\*

---

\*This procedure is outlined in "Specific Gravity of Tomato Pulp" (second paper), Research Laboratories, National Canners' Association. The temperature correction table is also given in this paper. Either Brix hydrometers giving direct specific gravity readings may be used. These should have a range from 4 to 10 degrees Brix, graduated to 1/10 degree, or the equivalent in direct specific gravity readings.

Tables have been prepared showing the number of gallons of finished product with any desired consistency that can be obtained from cyclone juice of any specific Brix reading. These tables are similar to those used in the concentration of ordinary tomato pulp and may be calculated to any desired consistency, such as the pulp tables of 1.040-1.042-1.045-1.047-1.050.†

Final concentration of the ketchup is controlled in the same manner as for pulp, either by a gauged tank or by specific gravity determination. The measurement of the final volume requires, of course, the use of a stick and a gauged tank. If we start, therefore, with a given volume of partially concentrated cyclone juice and determine the solids present, we can in every case quickly ascertain from the appropriate table the number of gallons of finished product we should obtain, and the gauge stick will indicate when to stop evaporation in the tank. One advantage of measuring the original volume at the boiling temperature is that no temperature corrections are necessary, as both the initial and final temperature measurements are approximately the same.

The final concentration may be controlled, as stated above, by determining the specific gravity of the finished product, using a suitable flask calibrated with water at the boiling temperature. The determination of specific gravity at this point will probably give more accurate results than the use of a gauge stick, and is to be recommended for use with the finished product, provided the added constituents have been standardized. The use of the flask and centrifuge method for determining the original solids is the boiling cyclone juice in place of the use of the Brix spindle on the filtrate gives satisfactory results.

The standardization of the sugar, acid, salt, onions and other constituents is very simple. Each gallon of finished product should contain a definite amount of each of these substances, as determined by the character of the ketchup desired.

The ketchup maker must find by experiment the quantities of these substances that give the desired flavor in a batch prepared from a known quantity of cyclone juice with known solid content. Since the final volume of the finished ketchup is known, it is simple to calculate the quantity of each constituent necessary for one gallon of finished ketchup. The quantities corresponding to the number of gallons of finished ketchup in the concentration table are then calculated and entered on the tables.

For example, suppose that we start with 800 gallons of cyclone juice (measured at the boiling point) with a corrected Brix reading of 7.0 degrees. If we find that the addition of 400 pounds of sugar, 30 gallons of 100-grain vinegar and 80 pounds of salt gives a satisfactory product when concentrated to approximately 465 gallons (the figures in the 1.045 table) we see that each gallon of finished ketchup requires  $400/465$  or 0.17 pound of salt. Values for the other constituents, such as onions, may be similarly calculated. Each figure for final volume given in the concentration table is now multiplied by the quantities per gallon, and the values so obtained placed in adjacent columns.

For example, assume that the ketchup maker desires a product of heavy body and good keeping quality, and that he uses for this purpose the concentration table used for producing 1.050 pulp. We will also assume that the basis of the ketchup is 800 gallons of pulp when at the boiling temperature. The following table may then be prepared:

---

†The final volumes for four different standard concentrations may be readily obtained by calculation from the ratios given in the paper referred to in the above footnote.



| FILTRATE FROM PULP |                     | ADDED CONSTITUENTS         |       |                    |       |        |
|--------------------|---------------------|----------------------------|-------|--------------------|-------|--------|
| Degrees Brix at    | Specific Gravity at | Volume of Finished Ketchup | Sugar | Vinegar, 100-Grain | Salt  | Onions |
| 68° F.             | 68° F.              | Gals.                      | Lbs.  | Gals.              | Lbs.  | Lbs.   |
| 3.50               | 1.0137              | 226.0                      | 203   | 18.1               | 45.2  | 33.0   |
| 3.60               | 1.0141              | 232.0                      | 209   | 18.5               | 46.4  | 34.8   |
| 3.70               | 1.0145              | 239.0                      | 215   | 19.1               | 47.8  | 35.9   |
| 3.80               | 1.0149              | 245.0                      | 221   | 19.6               | 49.0  | 36.8   |
| 3.90               | 1.0153              | 252.0                      | 227   | 20.2               | 50.2  | 37.8   |
| 4.00               | 1.0157              | 258.0                      | 232   | 20.6               | 51.8  | 38.7   |
| 4.10               | 1.0161              | 265.0                      | 239   | 21.2               | 53.0  | 39.8   |
| 4.20               | 1.0165              | 272.0                      | 245   | 21.7               | 54.4  | 40.8   |
| 4.30               | 1.0169              | 278.0                      | 250   | 22.2               | 55.6  | 41.7   |
| 4.40               | 1.0173              | 285.0                      | 257   | 22.8               | 57.0  | 42.8   |
| 4.50               | 1.0177              | 292.0                      | 263   | 23.4               | 58.4  | 43.8   |
| 4.60               | 1.0181              | 299.0                      | 269   | 23.9               | 59.8  | 44.9   |
| 4.70               | 1.0185              | 306.0                      | 275   | 24.5               | 61.2  | 45.9   |
| 4.80               | 1.0189              | 313.0                      | 282   | 25.0               | 62.6  | 47.0   |
| 4.90               | 1.0192              | 320.0                      | 288   | 25.6               | 64.0  | 48.0   |
| 5.00               | 1.0197              | 327.0                      | 294   | 26.2               | 65.4  | 49.1   |
| 5.10               | 1.0201              | 334.0                      | 301   | 26.7               | 66.8  | 50.2   |
| 5.20               | 1.0205              | 341.0                      | 307   | 27.3               | 68.2  | 51.2   |
| 5.30               | 1.0209              | 347.0                      | 312   | 27.8               | 69.4  | 52.1   |
| 5.40               | 1.0213              | 354.0                      | 319   | 28.3               | 70.8  | 53.2   |
| 5.50               | 1.0217              | 361.0                      | 324   | 28.9               | 72.2  | 54.2   |
| 5.60               | 1.0221              | 368.0                      | 331   | 29.4               | 73.6  | 55.2   |
| 5.70               | 1.0225              | 374.0                      | 337   | 29.9               | 74.8  | 56.2   |
| 5.80               | 1.0229              | 381.0                      | 343   | 30.5               | 76.2  | 57.2   |
| 5.90               | 1.0233              | 388.0                      | 349   | 31.0               | 77.6  | 58.2   |
| 6.00               | 1.0237              | 395.0                      | 356   | 31.6               | 79.0  | 59.3   |
| 6.10               | 1.0241              | 402.0                      | 362   | 32.1               | 80.4  | 60.4   |
| 6.20               | 1.0245              | 409.0                      | 368   | 32.7               | 81.8  | 61.4   |
| 6.30               | 1.0249              | 416.0                      | 374   | 33.3               | 83.2  | 62.5   |
| 6.40               | 1.0253              | 422.0                      | 380   | 33.8               | 84.4  | 63.4   |
| 6.50               | 1.0257              | 429.0                      | 386   | 34.3               | 85.8  | 64.4   |
| 6.60               | 1.0261              | 436.0                      | 392   | 34.9               | 87.2  | 65.4   |
| 6.70               | 1.0265              | 443.0                      | 399   | 35.4               | 88.6  | 65.5   |
| 6.80               | 1.0270              | 450.0                      | 405   | 36.0               | 90.0  | 67.5   |
| 6.90               | 1.0274              | 457.0                      | 411   | 36.6               | 91.4  | 68.6   |
| 7.00               | 1.0278              | 464.0                      | 418   | 37.1               | 92.8  | 69.6   |
| 7.10               | 1.0282              | 471.0                      | 424   | 37.7               | 94.2  | 70.7   |
| 7.20               | 1.0286              | 478.0                      | 430   | 38.2               | 95.7  | 71.8   |
| 7.30               | 1.0290              | 485.0                      | 437   | 38.8               | 97.1  | 72.8   |
| 7.40               | 1.0294              | 482.0                      | 443   | 39.4               | 98.5  | 73.8   |
| 7.50               | 1.0298              | 490.0                      | 449   | 39.9               | 99.9  | 74.9   |
| 7.60               | 1.0302              | 506.0                      | 455   | 40.5               | 101.3 | 76.0   |
| 7.70               | 1.0306              | 513.0                      | 462   | 41.1               | 102.7 | 77.0   |
| 7.80               | 1.0310              | 521.0                      | 469   | 41.7               | 104.2 | 78.2   |
| 7.90               | 1.0315              | 529.0                      | 476   | 42.3               | 105.8 | 79.4   |
| 8.00               | 1.0319              | 536.0                      | 482   | 42.9               | 107.2 | 80.4   |
| 8.10               | 1.0323              | 543.0                      | 489   | 43.5               | 108.6 | 81.5   |
| 8.20               | 1.0327              | 550.0                      | 495   | 44.0               | 110.0 | 82.6   |
| 8.30               | 1.0331              | 557.0                      | 501   | 44.5               | 111.4 | 83.6   |
| 8.40               | 1.0335              | 564.0                      | 508   | 45.1               | 112.8 | 84.7   |
| 8.50               | 1.0339              | 571.0                      | 514   | 45.7               | 114.2 | 85.7   |
| 8.60               | 1.0343              | 578.0                      | 520   | 46.2               | 115.6 | 86.8   |
| 8.70               | 1.0348              | 585.0                      | 527   | 46.8               | 117.0 | 87.9   |
| 8.80               | 1.0352              | 592.0                      | 533   | 47.4               | 118.4 | 88.8   |
| 8.90               | 1.0356              | 600.0                      | 540   | 48.0               | 119.0 | 90.0   |

Column 1 gives the correct Brix reading of the filtrate.

Column 2 gives the corrected specific gravity of the filtrate.

Column 3 shows the point at which evaporation is to be stopped; in other words, the volume of the finished ketchup.

Columns 4, 5, etc., show the amounts of sugar, vinegar, salt, etc., respectively, to be added to the batch.

The construction of a table of this character is impossible unless we start with the same volume of cyclone juice. If the pulp is not at the boiling temperature, variable quantities of air are occluded in the juice. Although the effect of the presence of this air may be discounted in the determination of solids either by the centrifuge or Brix method, there is no method of correcting for air in measuring the volume in the tank. This precludes the construction of a table based on tomato solids calculated from retermination of volume and gravity. This method, even if practicable, would necessitate a preliminary calculation of the tomato solids in every batch.

It is obvious that a table indicating the quantities of sugar, salt, etc., to be added to the cyclone juice cannot be prepared unless we always start with a fixed volume of cyclone juice as a base. This is why I recommend that the tank always be filled to a predetermined height with cyclone juice at the boiling temperature. Otherwise, in handling each batch, separate calculations will be necessary to ascertain the amount of sugar, salt, etc., to be added. This amount of mathematics would make the whole process impossible and would throw the whole procedure back to the rule of thumb. This method has equal superiority over other procedures outlined for the concentration of ordinary tomato pulp.

To summarize:

- (1) In order that the ketchup maker may produce a standardized product, it is necessary that he adopt uniform processes of manufacture.
- (2) To maintain standards for the finished product he must standardize both the base and the added constituents.
- (3) In standardizing the base he should start with fixed quantities of cyclone juice and control the concentration by tables similar to those used for pulp.
- (4) The amounts of sugar, vinegar, spice, etc., to be added vary only with the volume of the boiling cyclone juice and its Brix reading, and if the volume is a fixed quantity, the amount of added constituents varies only with the Brix reading. Hence, if a fixed quantity of boiling cyclone juice is used, it is possible to prepare tables which will show without additional calculation the exact amount of each added constituent for a batch or any Brix or specific gravity reading.

*Cucumber Catsup.*—Forty gallons cucumber pulp, 10 gallons vinegar, 10 pounds salt, 20 pounds ground horse radish, 1¼ pounds ground cayenne pepper, 10 ounces preservative. Select ripe cucumbers, peel and run through pulper. Put all ingredients, except horse radish and preservative, in kettle, cook to a thick sauce, turn off steam and add the horse radish and preservative. Bottle while hot.

*Mushroom Catsup.*—Pack 100 pounds mushrooms in a barrel, with alternate layers of salt, using 5 pounds of salt to the 100 pounds. Stand in a very warm place for 24 hours, then crush mushrooms and express the juice; place the juice in a kettle and



simmer for 15 minutes; then for each 5 gallons of the liquid add  $1\frac{1}{4}$  pounds crushed black pepper,  $\frac{1}{4}$  pound crushed allspice,  $\frac{1}{2}$  pound sliced green ginger root,  $\frac{1}{2}$  ounce whole mace, 2 ounces of whole cloves. Cook 15 minutes longer, strain and bottle while hot.

*Tomato Catsup*—Fine catsup depends for its goodness and flavor on the quality of the pulp; the spices being selected and added in small proportion with the intention of accentuating the tomato flavor, not disguising it.

Cook the high-grade goods in small batches, using not larger than 60-gallon kettles; for the cheaper grades, kettles up to 250 gallons may be used.

Home-made style is best made with moderate steam pressure in tanks fitted with copper coils.

The tomato flavor is best retained by cooking with either a very high or low steam pressure. Cook all regular goods with high pressure, but when working pulp, no matter if it is heavy and does not require it to bring to the proper consistency, an actual boil of not less than 30 minutes must be given to assure freedom from future fermentation. Usually 100 gals. pulp from the machine, or 66 to 70 gallons of prepared pulp will make 50 gallons finished catsup of the proper consistency. It is cooked properly when a small quantity, placed on unglazed paper, gathers in a globule, flattened at the base with no water separating, and remaining on the paper for some considerable time before the paper is dampened on the reverse side.

When using pulp salted at the time of making, deduct the amount of salt from the quantity called for by the formulae.

Sweet pulp made from table waste (unsalted), when boiled to catsup consistency, contains 7 per cent. dry matter and at 60 degrees the percentage of water added and specific gravity are given in the following table:

| WATER.           | SPECIFIC GRAVITY. |
|------------------|-------------------|
| 5 per cent.....  | 1.0365            |
| 10 per cent..... | 1.0347            |
| 15 per cent..... | 1.0325            |
| 20 per cent..... | 1.0315            |
| 25 per cent..... | 1.0300            |
| 30 per cent..... | 1.0285            |
| 35 per cent..... | 1.0275            |
| 40 per cent..... | 1.0265            |
| 45 per cent..... | 1.0255            |
| 50 per cent..... | 1.0245            |
| 55 per cent..... | 1.0230            |
| 60 per cent..... | 1.0227            |
| 65 per cent..... | 1.0215            |
| 70 per cent..... | 1.0195            |

Unless otherwise directed, use crushed spice with all dust sieved out, and chop the onions and garlic very fine; separate them from the cooked catsup either with a "shaker," or with a rotary pulper fitted with a very finely perforated metal plate; the very finest sieve on a rotary pulper will not give the results obtainable with perforated metal sheets.

There are good catsup finishing machines on the market, and large manufacturers of catsup highly endorse the work they do, and would not attempt to work without them.

If not provided with a finishing machine, tie the spices, onions, etc., with a stone or weight in a double cheese-cloth bag and allow double the cooking time.

Whole spices may be used directly in the pulp by allowing double the cooking time for crushed spices.

To make a finished catsup to contain 1-10 of 1 per cent. of benzoate of soda from bulk pulp previously prepared with 1-10th of 1 per cent. of benzoate of soda, use a sufficient quantity pulp free from preservative to make up the loss by evaporation in cooking to consistency. For instance, if three barrels of pulp will make two barrels of finished catsup, one barrel of the pulp must be free from preservative which practically means that one-third of the pulp must be from canned, cold storage or heavily salted goods.

In some localities the addition of the salt required in the finished article to one barrel of pulp will keep it, and on the above basis will produce the desired result.

Properly made catsup, and that means in addition to the right cook that perfect raw stock be used, containing no benzoate of soda may be bottled without a final processing if the following precautions are strictly observed; the bottles to be first washed, then sterilized either in steam or hot air—the catsup filled in the still hot bottles at a temperature of not less than 180 degrees and stoppered immediately. The keeping of all apparatus in a sanitarily clean condition is quite as important as the filling at 180 degrees.

To make tart catsup, follow any of the formulae, reducing the amount of sugar and increasing the vinegar.

To better preserve the flavor of catsup, bottle while hot; fill bottles to overflowing, and dip the softened corks in anti-mold before using.

Process bottled catsup, containing no preservative,  $\frac{1}{2}$  pints 30 minutes and pints 45 minutes at 212 degrees.

*Fancy Grade Sweet Catsup*—For some time past numerous complaints have been made that where high-grade sweet catsup is made direct from tomatoes and placed immediately in bottles, none of the ordinary preservatives was sufficient to prevent a greater or less amount of loss by fermentation. From investigations made, this appears to be caused by the development of spores, which were lying dormant when the cooking (which killed all native bacteria)



was done, and which developed by the moderate heat before the goods cooled off. This can be prevented either by giving the catsup a partial cook at first, stopping just short of the time for adding the vinegar, turning out of the kettle, cooling to 50 or 60 degrees and storing in barrels or tanks for 24 hours; then replace in kettle, bring to a boil and finish in the regular manner; or, the catsup may be first finished in the regular way, placed in bottles and at the expiration of 36 or 48 hours, process for the regular time at 212 degrees.

Take 50 gallons pulp from machine, 3 gallons 60-grain vinegar, 15 pounds sugar, 5 pounds salt, 5 pounds onions,  $\frac{1}{2}$  pound garlic,  $\frac{1}{4}$  pound cayenne pepper,  $\frac{1}{2}$  ounce bay leaves, 1 ounce powdered Saigon cinnamon.

Place the pulp from machine (or its equivalent in boiled-down canned stock) in kettle with the finely-chopped onions and garlic; bring to a boil. When the cook is about half completed, add the salt, sugar and cayenne papper; when within 10 minutes of the finish, add the cinnamon; then when completed, turn off steam, and run through finishing machine.

While the spicing and cooking as above is simple, it is quite easy to entirely change the character of the finished goods by varying the time for which the spices are cooked and by slightly changing the spicing. The onions are directed to be cooked from the first; by putting them in when the cook is half completed, an entirely different flavor is secured; and if cooked for only two minutes, still another flavor. The long cook gives a much better flavor to the catsup than the shorter cook, while the last cook of two minutes gives a better odor. By using double the quantity directed, and cooking one-half from the first, and giving the balance a two-minute cook, both results are obtained and the catsup improved thereby. The similar treatment of bay leaves also produces considerable difference, though not so decided as with the onions; allow a cook of 30 minutes instead of 10; more than 30 will give a woody flavor, and is not desirable.

The cinnamon may be doubled in quantity and a cook of two minutes given instead of five, and a still more delicate flavor will result. The Saigon cinnamon may be replaced with double the quantity of Ceylon cinnamon in the quill; this may be given a cook not to exceed four minutes and removed immediately on expiration of the time, or a barky flavor will result.

Bay leaves may be replaced with half their quantity of ground mace or crushed nutmegs.

Varying the amount of sugar and vinegar will make a considerable change on the same principle that one lemon and plenty of sugar will make a better lemonade than a half lemon and a small quantity of sugar. The vinegar used must be the best obtainable, a full, fine-flavored cider vinegar from sound apples, if procurable.

*Oyster Cocktail Catsup*—Forty gallons pulp (canned stock), 3

gallons 60-grain vinegar, 2 pints Worcestershire sauce, 10 pounds salted, ripe bull-nose peppers, 10 pounds sugar, 6 pounds salt, 6 pounds onions, 1 pound garlic, 3 pounds West India peppers, 2 ounces ground Saigon cinnamon.

Freshen and chop fine the peppers and place in kettle with the chopped onions, garlic, West India peppers and pulp; cook rapidly, and when cook is half done, add sugar and vinegar; when within five minutes of the finish add the cinnamon; when completed, turn off the steam and add the sauce; then finish in a rotary machine.

*Home-Made Style Catsup*—Forty gallons pulp from machine, 5 gallons vinegar, 10 pounds onions chopped very fine, 5 pounds salt, 5 pounds sugar, 1 pound ground black pepper, 1 pound ground allspice, 1½ pounds ground yellow mustard, ¾ pound ground ginger, ½ pound ground cloves, 2 ounces cayenne pepper, 1 gallon alcohol.

Place all the ingredients except the vinegar and alcohol in kettle or tank with copper coil, cook very slowly until reduced; turn off steam and add the alcohol. If it is not a good brown color add sufficient caramel to produce the desired shade. Place in bottles and sterilize. Do not pass this catsup through a finishing machine; the onions must be very finely chopped or grated.

*High-Grade Sweet Catsup*.—Forty-five gallons pulp, 3 gallons 60-grain vinegar, 15 pounds sugar, 5 pounds onions, 1 pound garlic, 5 pounds salt, ¼ pound cayenne pepper ground, ½ pound white pepper ground, 2 ounces Saigon cinnamon ground, ½ ounce mace. Use *canned steam-separated* pulp from entire tomatoes, or boiled-down pulp; cook same as Fancy Sweet Catsup, adding the white pepper and vinegar together; add the mace and cinnamon five minutes before the finish of cook.

*Medium-Grade Sweet Catsup*.—One hundred gallons pulp from machine, 3 gallons vinegar, 15 pounds sugar, 10 pounds salt, 5 pounds onions, 6 ounces ground cayenne pepper, 4 ounces ground white pepper, 4 ounces cloves, 2 ounces allspice, 2 ounces Saigon cinnamon, 1 ounce nutmegs.

Place the pulp, salt and sugar in kettle; when within ten minutes of the finish, add the vinegar and spices, which have been previously mixed; add the finely chopped onions two minutes before the finish.

*Standard-Grade Sweet Catsup*.—One hundred gallons barrel pulp, 5 gallons vinegar, 25 pounds sugar, 10 pounds onions, 12½ pounds salt, ½ pound ground white pepper, 10 ounces cayenne pepper, 4 ounces yellow mustard, 10 ounces powdered ginger, 2 pounds Saigon cinnamon, 2 ounces cloves, 2 ounces allspice. Cook same as preceding formula.

*Second-Grade Sweet Catsup*.—Two hundred gallons barrel pulp, 4 gallons vinegar, 25 pounds salt, 20 pounds sugar, 12 ounces ground cayenne pepper, 10 ounces coriander seed, 10 ounces ginger, 6 ounces allspice, 6 ounces cloves, 3 ounces Saigon cinnamon.



Cook same as medium grade.

*Worcestershire Sauce.* — Fifty gallons water, 9 pounds anchovies, 14 pounds tamarinds, 4 pounds dried mushrooms, 2 pounds ground Foemgreek seed, 6 pounds salt, 5 pounds chopped garlic, 10 pounds roasted onions,  $1\frac{3}{4}$  pounds cayenne pepper,  $2\frac{1}{2}$  pounds whole cloves,  $1\frac{1}{2}$  pounds bruised ginger, 2 ounces oil lemon, acetic acid sufficient.

Place all the ingredients except the oil of lemon and acetic acid in kettle, bring to a boil and cook slowly one hour. Turn off steam and add 3 gallons acetic acid or sufficient to make the vinegar strength 35 grains; then add the oil of lemon and place in a wooden package to ripen. This is a close imitation of the genuine, but requires 2 to 12 months to properly ripen.

### SALAD DRESSING

Here we enter a field that is filled with successes and failures. There are as many formulas for salad dressings as there are manufacturers.

Salad dressing to be manufactured and marketed in the ordinary manner should be of the mayonnaise type, and of this type there are two general classes, namely, the high oil content and the low oil content with all degrees between these two extremes.

In general, the dressings with low percentage of oil are of the cooked variety, while those with high percentage of oil are uncooked.

This is accounted for by reason of the fact that a dressing with high oil content, if properly made and bottled, will keep under ordinary commercial conditions without sterilization, while a dressing with low oil content as usually made will not.

There are on the market a number of dressings labeled "Salad Dressing" which should more properly be termed mustard dressing, as they contain no eggs.

#### *Working Formulas.*

The formulas in use are extremely varied and of large number. As stated, however, there are two general types, and a good working formula of each of these types is given below, with instructions for using.

#### *Cooked Mayonnaise With Low Oil Content.*

|                                   |            |
|-----------------------------------|------------|
| Eggs .....                        | 100 dozen  |
| Olive Oil ...'                    | 3 gallons  |
| Sugar .....                       | 55 lbs.    |
| Salt .....                        | 10 lbs.    |
| Mustard .....                     | 10 lbs.    |
| Arrowroot .....                   | 10 lbs.    |
| Vinegar, 40 gr. malt.....         | 20 gallons |
| Essence of Japanese peppers ..... | 1 pint     |

The eggs are thoroughly beaten in a water jacketed mixing machine; the oil is then slowly added while the mixer is running. Mix the sugar, salt, mustard and arrowroot with the vinegar and pepper essence; then gradually add the mixture while machine is running, heat being applied through the water jacket. Continue mixing until the temperature of the dressing has reached 165 degrees Fahrenheit. Then discontinue the heat; run machine for 10 minutes; draw off the dressing; run through the homogenizer and bottle hot, using bottles that have been thoroughly cleaned and heated just before filling. Close with vacuum closing machine. This should make 50 gallons.

*Uncooked Mayonnaise with High Oil Content.*

|                                 |            |
|---------------------------------|------------|
| Egg yolks .....                 | 8 gallons  |
| Olive oil .....                 | 30 gallons |
| Sugar .....                     | 15 lbs.    |
| Salt .....                      | 10 lbs.    |
| Mustard .....                   | 10 lbs.    |
| Vinegar, 100 gr. distilled..... | 7¼ gallons |

This will make about 50 gallons.

Place egg yolks in mixing machine, mix thoroughly and add the oil very slowly so that it will be thoroughly incorporated with the egg yolk, making a fine "butter." After all oil is added, add the vinegar slowly, then the sugar, salt and mustard. Run the machine until a smooth, perfect emulsion is produced. The dressing should then be put through a homogenizer and bottled, preferably under vacuum.

*General Information on Ingredients.*

*Oils.*—By far the best oil to use is prime or "virgin" olive. Other oils that may be and are used by different manufacturers are mustard, cottonseed, corn, rape, sesame, peanut, soybean and other fixed oils of edible grade.

*Colors.*—The yolk of eggs will, if used in sufficient quantity, impart a desirable color. Tumeric may be used and will impart a color considered by some as desirable. Harmless artificial colors as annato, naphthol yellows, etc., may be used, but their presence when so used must be declared on the label. They are not considered necessary or desirable.

*Vinegar.*—The desired acidity may be obtained by using malt, cider, wine, distilled, taragon or fruit vinegar. The use of acetic acid is not recommended. A good malt vinegar is considered the most desirable, although it is largely a matter of taste, etc.

*Fillers.*—Those in common use are starch (in the form of corn starch, flour, arrowroot, etc), gum tragacanth, Indian gum and gelatine. Of these the most desirable is a good grade of ribbon gum tragacanth, as it contains almost no starch and is therefore free from



the objection which applies to starch fillers—namely, that of being hydrolized by the vinegar acid, resulting in the dressing gradually becoming thinner with age.

*Mustard.*—Only high-grade mustard flour should be used. Of those now available it is recommended that either Colburn's or Coleman's be used.

*Eggs.*—The first choice in the eggs to be used should be fresh-laid stock; next, prime cold storage well candled before breaking; next, prime frozen stock. The use of dried or powdered eggs is not recommended.

*Preservatives.*—A few manufacturers still use—and declare on the label the presence of—benzoate of soda. This practice is not recommended, as no preservative of this nature is necessary, as the dressing if properly made and bottled, will keep indefinitely.

Lemon juice may be added with marked benefit in most formulas.

#### *Apparatus Needed.*

Proper provision for candeling and breaking eggs.

A suitable mixing or emulsifying machine. If a cooked type of dressing is to be made, this machine should be water-jacketed so that the proper degree of heat may be applied.

While not absolutely necessary, it is highly desirable to have a homogenizer to run the finished dressing through, as any tendency on the part of the dressing to separate will be obviated by the use of this machine.

A drawing tank with mixer or agitator.

A filling machine.

A capping or closing machine—here it is highly desirable to close under vacuum.

A labeling machine.

All metal parts to be covered with tin, silver or enamel.

#### SPICED VINEGAR.

1 pound Whole Cloves.

1 pound Whole Allspice.

½ pound Crushed Cinnamon.

½ pound Crushed Ginger Root.

5 gallons 45-grain Vinegar.

Soak the spices in the vinegar 12 hours; place in a suitable kettle and bring to a boil; then simmer gently one hour; strain off the liquid and add enough vinegar to make 5 gallons.

## CHEAP DRESSING.

- 5 gallons Prepared Mustard, German style.
- 2 pints Sweet, or Salad Oil.
- 1 gallon Spiced Vinegar, or enough to sufficiently thin the mustard.

Beat the oil into the mustard first, then add the vinegar gradually. To make a better grade, use olive oil and add 1 to 2 lbs. of sugar.

## HIGH-GRADE DRESSING.

- 10 pounds Flour.
- 7½ pounds Ground Yellow Mustard.
- 7½ pounds Ground Tumeric.
- 5 pounds Salt.
- 7½ pounds Sugar.
- 5 gallons Spiced Vinegar.
- 5 pints Olive Oil.

Mix all the dry ingredients with the cold, spiced vinegar; place on fire and stir continuously until it comes to a boil and thickens; remove from fire and stir in the oil, beating it until the oil globules disappear; cool and use.

Onions and garlic may be added in making the spiced vinegar if desired; also cayenne or chille pepper, if wanted very hot.





# FLAVORING EXTRACTS

## *Almond Extract—*

|                            |                    |
|----------------------------|--------------------|
| Oil of bitter almonds..... | 1.28 fluid ounces  |
| Grain alcohol .....        | 80.00 fluid ounces |
| Water .....                | 46.72 fluid ounces |

Makes one gallon. Filter if necessary.

## *Imitation Almond Extract—*

|                     |                    |
|---------------------|--------------------|
| Benzaaldehyde ..... | 1.5 fluid ounces   |
| Grain alcohol ..... | 50.00 fluid ounces |
| Water .....         | 76.50 fluid ounces |

Makes one gallon. Filter if necessary.

## *Allspice—*

|                       |                    |
|-----------------------|--------------------|
| Oil of allspice ..... | 2.56 fluid ounces  |
| Grain alcohol .....   | 92.00 fluid ounces |
| Water .....           | 33.44 fluid ounces |

Makes one gallon. Filter if necessary.

## *Anise Extract—*

|                            |                   |
|----------------------------|-------------------|
| Oil of anise .....         | 3.84 fluid ounces |
| Grain alcohol enough for.. | 1 gallon          |

## *Imitation Banana Extract—*

|                       |                 |
|-----------------------|-----------------|
| Amyl acetate .....    | 7.5 per cent.   |
| Chloroform .....      | .07 per cent.   |
| Acetic Aldehyde ..... | .2 per cent.    |
| Glycerine .....       | .4 per cent.    |
| Alcohol .....         | 54.00 per cent. |
| Water .....           | 37.83 per cent. |

1 oz. to 1 gallon syrup.

## *Celery Seed Extract—*

|                         |                     |
|-------------------------|---------------------|
| Oil of celery seed..... | .384 fluid ounces   |
| Grain alcohol .....     | 96.00 fluid ounces  |
| Water .....             | 31.616 fluid ounces |

Makes one gallon. Filter if necessary.

## *Cinnamon Extract—*

|                       |                    |
|-----------------------|--------------------|
| Oil of cinnamon ..... | 2.56 fluid ounces  |
| Grain alcohol .....   | 92.00 fluid ounces |
| Water .....           | 33.44 fluid ounces |

Makes one gallon. Filter if necessary.

*Cloves Extract—*

|                                        |                    |
|----------------------------------------|--------------------|
| Oil of cloves .....                    | 2.56 fluid ounces  |
| Grain alcohol .....                    | 92.00 fluid ounces |
| Water .....                            | 33.44 fluid ounces |
| Makes one gallon. Filter if necessary. |                    |

*Ginger Extract—*

|                                    |             |
|------------------------------------|-------------|
| Jamaica ginger, ground.....        | 25.6 ounces |
| Grain alcohol, enough to make..... | 1 gallon    |

Macerate the ginger in a closed vessel for 48 hours with part of the alcohol. Then pack the ginger in a glass percolator and percolate with alcohol until one gallon is obtained.

*Ginger Ale Extract—*

|                |                     |
|----------------|---------------------|
| Ginger .....   | .7 per cent. ground |
| Capsicum ..... | .6 per cent. ground |
| Oil Lemon..... | .6 per cent.        |
| Vanillin ..... | .1 per cent.        |
| Alcohol .....  | 50. per cent.       |
| Water .....    | 47.2 per cent.      |
| Caramel .....  | .8 per cent.        |

Place ginger and capsicum in alcohol, macerate four days and filter; add oil lemon, vanillin, and then other ingredients, and filter clear.

To make ginger ale syrup, use 2 oz. extract, 1½ oz. of 50 per cent. solution citric acid, 5 lbs. sugar, and water enough to make 1 gallon.

*Lemon Extract—*

|                         |              |
|-------------------------|--------------|
| Prime oil of lemon..... | 5 per cent.  |
| Grain alcohol .....     | 85 per cent. |
| Water .....             | 10 per cent. |

If color is desired use lemon peel. Any other coloring agent is considered artificial, and would have to be so declared on the label.

*Terpeneless Lemon Extract (Soluble Lemon Extract)—*

This may be made by mixing terpeneless oil of lemon with diluted alcohol, or better, by using pure oil of lemon and using the washing-out method. The latter method is as follows:

## METHOD OF MANUFACTURE.

*Equipment Needed*—Provide a good, tight, clean alcohol barrel. Make a hand hole of about eight inches in diameter in one head near the chime, and fit with a water-tight closure that can be



easily opened and closed. Place pivot arms on each side of barrel at its center, so that it can be tumbled by a belt-driven pulley attached to one of the pivot arms. Rig a substantial stand to carry the barrel and provide power, preferably by electric motor, to revolve the barrel at a speed slow enough to tumble the contents.

The following sketch will illustrate roughly:



Next provide separate tanks, one or as many as desired. These should preferably be made of copper, well tinned on the inside. Galvanized iron would do for a short time, if the better material is not obtainable. These tanks should be of at least 40-gallon capacity each, and should be constructed with a bottom set in at a considerable angle with faucet at the lowest point. For convenience in observing the line of separation of liquids, a glass guage column should be provided. Also provide one or more plain storage tanks of at least 100-gallons capacity. This constitutes all the equipment that is required.

#### *Working Formulas—*

Take 50 pounds of first-class oil of lemon and 25 pounds granulated sugar. Place both in the barrel. Close and let tumble for at least six hours. The use of sugar here is quite essential in producing a high grade product. There are two reasons for its use. The first is not so essential, namely, the mechanical action of separating the oil into fine parts and exposing a large surface. The second and important reason is the action of the sugar in forming esters and thereby producing a finer bouquet. This feature is unknown to nearly all manufacturers who have attempted to produce this product. Sugar also incidentally acts as a preservative of the aldehydes. Theoretically, this quantity of oil should make 1000 pints of finished product, of a strength equal in flavoring power to the ordinary lemon extract, but it is considered much better practice to make only 800 pints, thereby being absolutely certain that

more than the required amount of citral will be present in the finished product, also producing a much finer product.

After tumbling the oil and sugar for six hours, add 125 pints alcohol; tumble for one hour and add 75 pints cold water (filtered if necessary) and tumble for nine hours. Then draw off entire contents of barrel; place in the settling tank, and allow to stand for three days, after which draw off carefully from the faucet the entire lower layer of liquid, which will contain a large part of the citral and other aldehydes dissolved in the dilute alcohol. Place this solution in the storage tank. Now draw off remaining top layer of terpenes and place back in the tumbling barrel; add 100 pints alcohol and 100 pints water, and let stand three days, and separate as in the first operation, placing the citral solution in storage tank with the first washing and putting the terpenes back in the tumbling barrel. Now add to the terpenes 100 pints alcohol and 100 pints water, and tumble for nine hours. Draw off and put in settling tank for three days, then draw off the solution and place in storage tank with first two washings. Place the terpenes back in the barrel and add 125 pints water and 75 pints alcohol, and tumble for nine hours. Draw off and place in settling tank, allow to remain three days; draw off the solution and place in storage tank with three other washings. All four washings will now be in the storage tank and will show a volume of close to 800 pints. Mix thoroughly, and the finished product is thus obtained.

The terpenes now remaining are worthless as a flavoring agent, but can be sold to some of the oil importers in New York and Chicago.

This, as will be noted, gives a finished product containing about 50 per cent. alcohol, which is believed to be the best. It can be varied by using less alcohol in washings 2, 3 and 4, but not to a point which will render the finished product below 40 per cent. alcohol. The finished product is filtered if necessary before bottling.

While the barrel has been found by practical experience to be entirely satisfactory as a mixer, it is believed that an apparatus built in the form of a cube, such as is used in some of the concrete mixers, would be even better.

#### *Lime Extract—*

|                     |              |
|---------------------|--------------|
| Oil of limes.....   | 5 per cent.  |
| Grain alcohol ..... | 85 per cent. |
| Water .....         | 10 per cent. |

#### *Terpeneless Lime Extract—*

(Soluble lime extract)

Same method as for Terpeneless lemon, using oil of limes instead of oil of lemon.



*Mace Extract—*

|                     |                    |
|---------------------|--------------------|
| Oil of mace .....   | 2.56 fluid ounces  |
| Grain alcohol ..... | 95.00 fluid ounces |
| Water .....         | 30.44 fluid ounces |

Makes one gallon. Filter if necessary.

*Imitation Maple Extract—*

|                                     |            |
|-------------------------------------|------------|
| Ground Fenugreek seed .....         | 10 lbs.    |
| Ground celery seed .....            | 1 ounce    |
| Vanillin .....                      | 1 ounce    |
| Coffee extract .....                | 1 pint     |
| Caramel .....                       | 1 pint     |
| Alcohol and water, equal parts..... | 4½ gallons |
| Oil lovage .....                    | 4 drops    |

Macerate the fenugreek and celery seed in a part of the mixture of alcohol and water for 24 hours; then percolate with remainder of menstrum.

Dissolve the oil of lovage and vanillin in a little alcohol and add the coffee extract and caramel, and allow to age for at least 30 days.

The coffee extract recommended is made by percolating 5 pounds of high-grade ground coffee with a mixture of two parts hot water and one part alcohol until 4 gallons are obtained.

*Note:* This imitation maple extract, when used in small quantities, will give a delicate maple-like flavor.

*Nutmeg Extract—*

|                     |                    |
|---------------------|--------------------|
| Oil of nutmeg ..... | 2.56 fluid ounces  |
| Grain alcohol ..... | 95.00 fluid ounces |
| Water .....         | 30.44 fluid ounces |

Makes one gallon. Filter if necessary.

*Orange Extract—*

|                           |              |
|---------------------------|--------------|
| Prime oil of orange ..... | 5 per cent.  |
| Grain alcohol .....       | 85 per cent. |
| Water .....               | 10 per cent. |

If color is desired, use orange peel. Any other coloring agent is considered artificial and will have to be so declared on the label.

*Terpeneless Orange Extract—*

(Soluble orange extract)

Same method as for lemon, except substitute oil of orange for oil of lemon.

*Peppermint Extract—*

|                         |                     |
|-------------------------|---------------------|
| Oil of peppermint ..... | 3.84 fluid ounces   |
| Grain alcohol .....     | 124.16 fluid ounces |

Makes one gallon.

If color is desired, add peppermint leaves, soak and filter; any other color is considered artificial and would have to be so declared on label.

*Imitation Pistache Flavor—*

|                             |                |
|-----------------------------|----------------|
| Oil of orange .....         | .7 per cent.   |
| Oil of Bergamot .....       | .1 per cent.   |
| Oil of bitter almonds ..... | .1 per cent.   |
| Pistachio nuts .....        | .3 per cent.   |
| Alcohol .....               | 80.0 per cent. |
| Water .....                 | 18.8 per cent. |

If color is desired, it may be added, but will have to be declared on label.

*Imitation Peach Flavor—*

|                        |                 |
|------------------------|-----------------|
| Glycerine .....        | 2.5 per cent.   |
| Acetic aldehyde .....  | .12 per cent.   |
| Acetic ether .....     | 5.00 per cent.  |
| Formic ether .....     | 2.5 per cent.   |
| Amyl valerianate ..... | .5 per cent.    |
| Benzaldehyde .....     | .13 per cent.   |
| Alcohol .....          | 63.00 per cent. |
| Water .....            | 25.25 per cent. |

*Imitation Pineapple Flavor—*

|                     |                 |
|---------------------|-----------------|
| Buteric ether ..... | 6.00 per cent.  |
| Amyl acetate .....  | 1.50 per cent.  |
| Glycerine .....     | 1.50 per cent.  |
| Citric acid .....   | .10 per cent.   |
| Alcohol .....       | 63.00 per cent. |
| Water .....         | 27.90 per cent. |

*Rose Extract—*

|                     |                      |
|---------------------|----------------------|
| Oil of rose .....   | .512 fluid ounces    |
| Grain alcohol ..... | 127.488 fluid ounces |
| or                  |                      |
| Oil of rose .....   | .4 per cent.         |
| Alcohol .....       | 50.0 per cent.       |
| Water .....         | 49.6 per cent.       |



*Imitation Raspberry Extract—*

|                        |       |           |
|------------------------|-------|-----------|
| Succinic acid .....    | .50   | per cent. |
| Acetic ether .....     | 2.50  | per cent. |
| Benzoic ether .....    | .50   | per cent. |
| Butyric ether .....    | .60   | per cent. |
| Sebacic ether .....    | .40   | per cent. |
| Orris root .....       | .20   | per cent. |
| Tartaric acid .....    | .50   | per cent. |
| Formic ether .....     | .50   | per cent. |
| Amyl valerianate ..... | .70   | per cent. |
| Alcohol .....          | 70.00 | per cent. |
| Water .....            | 22.10 | per cent. |

*Imitation Sarsaparilla Extract—*

|                          |      |           |
|--------------------------|------|-----------|
| Oil of wintergreen ..... | 2.5  | per cent. |
| Oil of sassafras .....   | 3.5  | per cent. |
| Grain alcohol .....      | 73.0 | per cent. |
| Water .....              | 20.2 | per cent. |
| Caramel .....            | .8   | per cent. |

*Imitation Strawberry Extract—*

|                     |       |           |
|---------------------|-------|-----------|
| Benzoic ether ..... | .12   | per cent. |
| Butyric ether ..... | 2.00  | per cent. |
| Acetic ether .....  | 2.00  | per cent. |
| Amyl acetate .....  | .12   | per cent. |
| Alcohol .....       | .63   | per cent. |
| Water .....         | 32.06 | per cent. |
| Formic ether .....  | .70   | per cent. |

*Spearmint Extract—*

|                        |        |              |
|------------------------|--------|--------------|
| Oil of spearmint ..... | 3.84   | fluid ounces |
| Grain alcohol .....    | 124.16 | fluid ounces |

If color is desired, add spearmint leaves, soak and filter. Any other color is considered artificial and would have to be so declared on label.

*Vanilla Extract—*

The proper selection of vanilla beans for extract is an art in itself, and the small manufacturer with limited experience should perhaps rely on the judgment of the reliable bean importer rather than his own.

The principal varieties of vanilla beans are in the order of their merit—Mexican, Bourbon, South American, Java, Tahiti. For the finest extract none but prime Mexican beans should be used. The next best extract will be made from a mixture of Mexican and Bourbon beans, etc.

*Method of Manufacture*—After selecting the beans which are to be used, they should be chopped rather fine by a machine.

*Formula.*

|                                  |            |
|----------------------------------|------------|
| Vanilla beans, chopped fine..... | 128 ounces |
| Sugar, granulated .....          | 60 ounces  |
| Glycerol .....                   | 60 ounces  |
| Alcohol }                        |            |
| Water }                          |            |

equal parts, enough to make 10 gallons.

The vanilla beans should be mixed with the sugar and glycerine and enough of the alcohol water mixture added to make a wet mass. Let macerate in a closed vessel for 48 hours; then pack in a cylindrical percolator, and percolate slowly with the alcohol water mixture until ten gallons of extract are obtained.

The best type of percolator is one made of copper, well tinned on the inside and water jacketed on the outside, so that heat may be applied. It is highly desirable to pack the beans in the percolator to a depth of six inches and then insert a porous mat of clean asbestos or excelsior; then another six inches of beans and another mat, etc., until percolator is nearly full. Heat should be applied by means of the water jacket to a degree that will maintain a temperature of 135 degree F. in the contents of percolator. The best method of extraction is to force the menstrum by gravity pressure into bottom of percolator and allow the extract to come off at the top. The rapidity of flow can be regulated by the degree of opening menstrum supply line, and should be such that complete extraction will be completed in about seven days.

When the entire quantity called for by the formula has been obtained from the percolator, it should be aged for 30 days or more before marketing, as it will be much improved thereby.

*Imitation Vanilla Extract*—

|                                  |           |
|----------------------------------|-----------|
| Vanillin .....                   | 8 ounces  |
| Coumarin .....                   | 1 ounce   |
| Glycerine .....                  | ½ gallon  |
| Sugar .....                      | 6 lbs.    |
| Alcohol .....                    | 3 gallons |
| Water—enough to make 10 gallons. |           |
| Caramel—enough to color.         |           |

Dissolve the vanillin and coumarin in the alcohol, dissolve the sugar in the water. Mix all together, add enough caramel to give desired color, and filter if desired. The color may be omitted where desirable.



*Imitation Wild Cherry Extract—*

|                             |                |
|-----------------------------|----------------|
| Oil of bitter almonds ..... | .50 per cent.  |
| Amyl valerianate .....      | .3 per cent.   |
| Citric acid .....           | .8 per cent.   |
| Alcohol .....               | 65.0 per cent. |
| Water .....                 | 33.4 per cent. |
| Color with rhatany root.    |                |

*Wintergreen Extract—*

|                                        |                    |
|----------------------------------------|--------------------|
| Oil of wintergreen .....               | 3.84 fluid ounces  |
| Grain alcohol .....                    | 90.00 fluid ounces |
| Water .....                            | 38.00 fluid ounces |
| Makes one gallon. Filter if necessary. |                    |

*Imitation Wintergreen Extract—*

This may be made by substituting methyl salicylate or the oil of sweet birch for the oil of wintergreen in the formula for wintergreen extract.

## SPICE MIXTURES

*Curry Powder—*Three pounds powdered tumeric, 3 pounds powdered coriander seed, 1 pound powdered white pepper,  $\frac{1}{4}$  pound powdered cayenne pepper, 1 pound powdered Jamaica ginger, 1 pound powdered yellow mustard,  $\frac{1}{2}$  pound powdered allspice;  $\frac{1}{2}$  pound powdered cardamon seed,  $\frac{1}{4}$  pound powdered cumin seed,  $\frac{1}{4}$  pound powdered cloves. Mix well together.

*Catsup Spices (Powdered)—*Four pounds white pepper,  $\frac{1}{2}$  pound cayenne pepper,  $\frac{1}{4}$  pound nutmegs,  $\frac{1}{4}$  pound cloves,  $\frac{1}{4}$  pound Saigon cinnamon,  $\frac{1}{2}$  pound coriander seed,  $\frac{1}{2}$  pound thyme,  $\frac{1}{4}$  pound marjoram,  $\frac{1}{4}$  pound bay leaves. Mix.

*Catsup Spice (Powdered)—*Two pounds white pepper, 2 pounds allspice,  $\frac{1}{2}$  pound cloves, 1 pound yellow mustard,  $\frac{1}{2}$  pound peach leaves,  $\frac{1}{2}$  pound cayenne pepper.

*Catsup Spice (Powdered)—*Three pounds white pepper,  $\frac{1}{2}$  pound cayenne pepper,  $\frac{1}{2}$  pound allspice,  $\frac{1}{2}$  pound cloves, 1 pound celery seed. Mix.

*Soup Spices (Powdered)—*Half pound lemon peel, 1 pound thyme,  $\frac{1}{2}$  pound sweet marjoram,  $\frac{1}{2}$  pound summer savory, 1 pound parsley,  $\frac{1}{4}$  pound celery seed,  $\frac{1}{4}$  pound sweet basil. Mix.

# PICKLING

All tanks, casks or barrels used in salting vegetables for pickles or soups should be provided with a loose cover of boards or plank, fitting inside the container, a few inches below the top, and with cleats or other suitable means, that the vegetables can be kept under the surface of the brine. When the tank is full, cover the vegetables with cheese-cloth or other suitable material. Place the cover in position and fasten down. Skin off all froth and foam, and keep the top covered with 60-degree brine. When fermentation has ceased, remove cover, take off cloth and wash both free from all slime and dirt; replace and cover with brine. From time to time add sufficient 60-degree brine to keep cover submerged. Large tanks used for dry salting must be provided with a pump-box or shield on one side, so that the brine may be pumped from the bottom to the top of the tank when it is heavier at the bottom than at the top.

Unless otherwise mentioned, brine is to be 60-degree by salometer.

*Beans, String and Lima.*—Blanch the beans in boiling water, pack in tanks, sprinkle with a quarter of a bushel salt to each 16 bushels; fasten down top and cover with 60-degree brine.

*Cauliflower.*—Trim and break the cauliflower apart, blanch one minute in a bath containing one ounce of sulphite of soda to 12½ gallons water; pack in tank and sprinkle each 16 bushels with ½ bushel salt. When tank is full, place lid, and cover with 60-degree brine.

*Citron, Domestic.*—Pare the citron and remove all soft pulp and seed; cut the flesh in small pieces and pack in tanks; sprinkle each 16 bushels with ½ bushel salt; fasten down cover, and cover with 60-degree brine.

*Corn.*—Cut from cob in whole grains, silk and pack in tank with ¼ pound salt to each 16 bushels; place cover and fill with 16-degree brine.

*Cucumbers.*—Pack in tank as tightly as possible with ½ bushel salt to each 4 bushels, using just enough water to moisten the salt; if they do not make brine enough to cover themselves in a few days; fill up with 60-degree brine.

*Onions.*—Pull onions when the desired size, selecting only those which have been entirely covered with earth. Store in slatted crates or ventilated barrels in a cool, airy place, until the tops are thoroughly dried; then rub and sieve to remove all adhering soil. Pack in tank, using 18 pounds salt to 100 pounds onions. Let stand for a few days; refill with onions, place lid and cover with 60-degree brine.



*Pumpkin.*—Same as citron.

*Peppers, Bull-nose, Ripe or Green.*—Cut out stem, remove core and seed, pack in tank nose down; sprinkle with  $\frac{1}{4}$  bushel salt to each 16 bushels; place cover and fill with 60-degree brine.

*Sauerkraut.*—Cut off the outside green leaves of the cabbage, core and cut; for each 100 pounds of cut cabbage mix  $2\frac{1}{2}$  pounds salt; pack tightly in barrels or tanks to ferment. If wanted for quick shipment, pack in barrels, and stand in a warm place to ferment. After fermentation, refill barrels, head and ship.

*Cucumbers.*—Place salted cucumbers in a process tank containing a perforated steam coil covered with an inverted trough so that the pickles cannot come in direct contact with the steam. Cover well with cold water and heat to 100 degrees; soak 12 hours, then drain off the liquid; again cover with cold water, and heat to 120 degrees; soak 12 hours and drain off liquid; cover the third time with water. Heat to 135 degrees, soak 12 hours, and the pickles are ready for vinegar.

Sort the pickles according to size, and place in packages with a sprinkling of whole mixed spices, 2 parts yellow mustard seed, one part each of allspice, cloves and bruised ginger root, and West India or bird peppers; also a little horse radish root on top; then fill with  $42\frac{1}{2}$ -degree grain vinegar.

*Dill Pickles.*—Have well-coppered barrels; take out head, and in bottom place a handful of dill with a clever sprinkling of mixed spices; pack half full of cucumbers and another handful of dill with spices; fill barrel with cucumbers, finishing the top with dill and spices. Head up barrel and fill through bunghole with 50-degree brine, to each 45 gallons of which has been added 2 gallons 45-grain vinegar. Bung up barrel; bore a hole through the bung in which place a nipple connected with a half-inch rubber tube, the end of this dropping in a bottle filled with water. If in a hurry use 30-degree instead of 60-degree brine.

*Mixed Pickles.*—Process small cucumbers, corn, cauliflower, beans, etc., same as cucumbers; place in bottles with mixed spices and onions, and fill with  $42\frac{1}{2}$ -grain vinegar.

*Pickled Onions*—Remove from brine and peel; place in process tank cover with cold water, and heat to 90 degrees; in a few days a secondary fermentation will take place; once or twice a day press down the floaters and allow to remain until the onions have bleached to the desired shade of whiteness; then wash well in cold water and place in packages, adding a sprinkling of spices, whole mustard seed (yellow), 2 pounds; whole mace, 1 pound, and West India peppers, 1 pound, and cover with prepared vinegar (50 gallons 45-grain vinegar, 4 ounces preservative,  $\frac{1}{2}$  pound alum.)

*Sweet Pickles.*—Prepare and pack pickles, salt same as for “mixed pickles,” and cover with sweet liquor instead of vinegar. For this, place in 50 gallons 45-grain vinegar, 10 pounds black mustard seed, 5 pounds West India pepper, 5 pounds Jamaica ginger root, 4 pounds whole black peppers, 4 pounds whole allspice, 1½ pounds whole cloves, 1 pound whole mace, 5 pounds horseradish, 2 pounds celery seed, 5 pounds chopped garlic. Soak twelve hours, place in kettle, bring to a boil, then strain and dissolve therein 30 to 50 pounds sugar, according to sweetness desired.

The more sugar used the greater the cost, and more crisp the resulting pickle.





# FISH

Aside from salmon and sardines, comparatively little attention has been paid to fish canning, though the demand, particularly for the salt-water varieties, is increasing. After being caught, the quicker the treatment of the fish begins at the factory, the better the quality of the product obtained. Putrefaction sets in quicker than in meat, and the stock must be promptly handled. If fish are iced or kept in cold storage they require treatment the moment after removal.

## SARDINES.

Sardines may be prepared from any small fish of the herring family, the most suitable species varying in different localities. Fish from 4 inches to 7 inches in length are best suited for sardines in oil in the ordinary rectangular or  $\frac{1}{4}$ -lb. cans, and from 7 inches to 10 inches for fish in larger cans, such as  $\frac{3}{4}$  rectangular or  $\frac{1}{2}$  or 1 lb. oval cans. In Maine most of the sardines are taken in large traps, known as weirs, constructed in channels and bays by means of upright stakes, the spaces between which are filled in by netting or brushwood. The fish are diverted from their course into the weir by a long barrier of similar construction extending out from shore to the mouth of the weir, and their escape is prevented by the form of opening. The fish are captured by surrounding them with a seine or net and are dipped into dories, from which they are transferred to power-boats, which carry them to the factories. The fish die almost immediately on being taken from the water, and are sprinkled with salt to preserve them. In California and Europe most of the sardines are taken in nets.

*Canning Process.*—Convey the fish from the boats to the factory by sluices and running water. The fish running over six inches in length should have the heads and viscera removed. Then immerse them in strong brine (80 degree to 90 degree salometer scale) for one or two hours, depending on size of fish and previous length of time in salt. Spread the fish on frames made of galvanized wire screening, and prepare for packing in either of two ways. By the first method, cook the fish in live steam for about ten minutes, then dry them in a room through which a continuous current of warm air is passed for about one and a half to two hours. In the second method the fish are first dried as above and then fried by immersing in a tank of cottonseed, olive or peanut oil, heated to 260 to 280 degrees Fahrenheit, until the fish come to the surface of the oil. After being prepared by either method and allowed to cool, the fish are ready to pack in the cans, after removing all fish heads. In case of fish which are still too large to pack in the cans properly, the tails

should be clipped off by the packers. In case of sardines in mustard or tomato sauce, add the sauce before the fish are placed in the cans, but the oil in which sardines in oil are packed may best be added after the fish are in the cans. The cans are then covered and passed through the sealing machines and "processed" or sterilized by immersion in water kept boiling continuously for one and a half to two hours in case of  $\frac{1}{4}$  cans and for two to two and a half hours in case of  $\frac{3}{4}$  cans. Quicker and more certain sterilization may be secured in retorts under pressure. Sardines may also be prepared by drying the fish, then smoking them and packing them in oil.

For sardines in oil, high-grade olive, cottonseed, peanut or corn oil should be used. The grade of cottonseed oil recommended is that known as "winter yellow," as lower grades thicken and become more or less opaque in cold weather, and sometimes have a rank flavor.

Tomato sauce should be prepared from good quality of tomato pulp or tomato paste, and should have a density of not less than 1.035. Salt and spices may be added to suit the taste.

Mustard sauce is prepared by crushing mustard seed, black pepper, cayenne and tumeric in a spice-mill, mixing them thoroughly with dilute distilled vinegar and salt in a tank provided with an agitator, and passing the fluid through horizontal stone grinding mills till of smooth and even consistency.

Maine sardines in oil are usually put up in  $\frac{1}{4}$  cans of three types—the keyless or two-piece can, the roll-top key can and the "hermetic" key can. They are packed, one hundred cans to a case, the gross weight of a case being about forty-one pounds.

Maine sardines in tomato sauce are usually put up in  $\frac{1}{4}$  roll-top key cans, one hundred cans to the case.

Sardines in mustard sauce are put up in the first two types of  $\frac{1}{4}$  cans used for sardines in oil and also in two types of  $\frac{3}{4}$  cans, viz., the keyless and the key can. Three-quarter cans are usually packed forty-eight to a case, the gross weight of a case being about fifty pounds.

During the season of 1918 fifty-seven factories were in operation along the Maine coast and two factories in Massachusetts.

The California sardine industry is comparatively new, having only attained great commercial importance during the past four or five years. It was first developed as a side line for the canneries packing tuna in Southern California, to keep them in operation during the times when the run of tuna fell off, but it now promises to outstrip the older industry which it was planned to supplement. About thirty factories in Southern California are engaged in packing sardines.

The California sardine is a different species of fish—darker in color along the back than the Maine sardine, and has a horizontal row of large black spots along the side of the body.



Sardines are prepared in California both by a steaming and by frying process. The fish average a good deal larger in size than the Maine sardines. The heads and viscera are removed before cooking. The sardines put up in round, flat tuna cans are generally prepared by a steaming process, while sardines in the ordinary rectangular forms of sardine cans and in oval cans are usually cooked by frying.

French and Spanish sardines are prepared mostly from the fish called the pilchard by a frying process, while Norwegian sardines are produced from the sprat or brisling, which is dried and smoked. Sardines in considerable amount are also produced in Portugal and Japan.

### SALT WATER FISH.

*To Can Salt Water Fish* of a suitable size for No. 2 cans, such as sea trout (weak fish), sea bass, herring, etc., scale, cut the gills and pull out the interior, or cut off the head just forward of the shoulder, slit down the belly to vent and remove entrails; cut off all fins and cut fish to can lengths; wash off in clean water. Cover the fish with a generous quantity of 60 degrees (salometer) brine and soak one or two hours, according to thickness of fish; they must remain until all the blood is extracted. (Never use brine the second time.) A No. 2 can will hold three or four fish of the proper size; if three, place the first two in shoulder first and the last one tail first; if four, place the first two in shoulder first and the last tail first. Fill the cans with brine (3 lbs. salt, 12½ gallons water), exhaust 10 minutes at 212 degrees and process 45 minutes at 240 degrees, then raise to 250 degrees for 10 minutes, remove from retort and place in cooling bath.

*For Blue Fish, Cod* and other large salt water fish use flat cans. Clean and cut in pieces of suitable size, soak in brine until blood is extracted, pack in cans, exhaust and process same as above. If fish are very large, split down back and remove backbone.

### CORNED FISH.

Scale the fish, cut off heads, split down back, clean and wipe dry (do not wash). For 100 pounds fish intimately mix 5 pounds salt, 5 pounds brown sugar, 5 ounces powdered saltpeter, and rub fish, inside and out, with the mixture. Pile the fish skin down in tanks and weight. Allow them to remain 48 to 60 hours, according to thickness of fish. Then wash and drain, cut to can size, place in can, fill with sauce (water, 12½ gallons; 60-grain vinegar, 1 gallon; whole cloves, ½ pound; bay leaves, ½ ounce; chopped onions, 2 pounds; salt, 3 pounds; whole black pepper, ½ pound). Soak pepper, cloves and bay leaves 48 hours or more in the vinegar. Place the water, salt and onions in kettle, bring to a boil and cook 30 minutes; then add the vinegar and spices, let boil one minute and strain. Close

and process at 240 degrees, 1-lb. cans 30 minutes, 2-lb. cans 45 minutes.

Small fish may have the heads left on and be packed dry in oblong flat cans, exhaust 10 minutes at 212 degrees and allow 10 minutes more process time.

Either large or small fish may be drained and lightly smoked, packed dry, exhaust 10 minutes and allow same process as for corned.

#### SMALL FISH IN OIL.

Clean and cut to can size, soak in brine as before directed, remove and dry in a blast of dry, warm air; spread on wire trays and dip in sweet oil heated to a temperature of about 300 F. (Oil boils at about 360 degrees; this is too hot and will soften the fish.) As soon as fish are cool enough to handle, pack tightly in can, fill with hot oil, seal, process at 240 degrees, 1-lb. cans 25 minutes, 2-lb. cans 35 minutes.

#### SMALL FISH IN BOUILLON.

Prepare the fish, reserving the heads and trimmings same as directed for small fish in oil, or broil them over a naked fire or under gas; pack in cans, fill with bouillon and process same as fish in oil.

*Sauce.*—For the bouillon place 10 gallons of the washed heads and trimmings in a suitable kettle, add 12 gals. cold water, 2 lbs. chopped onions,  $\frac{1}{2}$  lb. whole juniper berries,  $\frac{1}{4}$  lb. grd. white pepper, 2 ozs. grd. red pepper; bring to a boil, then simmer gently one to two hours; strain off the liquid and add 3 per cent. of salt.

A splendid sauce is made of the "melts" as follows: Ground melts, 5 lbs.; water, 5 pts.; grd. onion, 5 oz.; juniper berries, 2 oz.; pepper and salt sufficient.

#### SALMON.

Salmon are caught principally in traps, drag-seines, purse-seines and gill-nets for commercial purposes in the waters of the Pacific Ocean and tributary bays and rivers from the Sacramento River in California to Kotzebue Sound, Alaska, which is within the Arctic Circle.

The method of canning salmon in the so-called "sanitary" cans of the low or flat form is as follows:

The salmon are carried from the lighters or scows by means of conveyors into the fish shed, where they are sorted and washed. From there they are carried on elevators to a machine known as the "iron chink," which slits the fish, removes the entrails and cuts off the heads, fins and tail. After passing through this machine the fish are scrubbed and thoroughly cleaned in running water and then passed through a slicing machine, which cuts the fish transversely



into pieces of any desired thickness. These slices are then carried to the packers to be placed in the cans. About  $\frac{1}{2}$  ounce of salt is placed in each pound can before it is filled.

The filled cans then pass through machines where the covers are partially crimped on, and then pass through an exhaust box, where they are subjected to live steam for about seven minutes to heat up the can and contents so that the cans will be sealed hot. From the exhaust boxes the cans are then conveyed to closing machines, which complete the closing of the cans; they are then carried to the retorts for final cooking or "processing."

The average time and temperature of processing is about 75 minutes at 240 degrees Fahrenheit. The backbone should be thoroughly cooked and softened in this process.

If the cans are tight, the tops which bulge when the cans are removed from the retort should become concave on cooling. If any of the cans do not bulge at the ends when removed from the retort or the covers do not become concave on cooling, such cans are examined for leaks and repaired as promptly as possible, after which they are again placed in the retort for necessary sterilization.

The cans are spread out as much as possible in the storage shed for cooling, and when cold are ready for labeling, after they have again been examined for leaks.

Every case of canned salmon ordinarily contains 48 one-pound cans.

### CRAB MEAT.

Do not steam the crabs, but cook in water in which for each 25 gals. has been dissolved 1 lb. bicarbonate soda (common baking soda); bring to a jumping boil, dump in the live crabs, bring to a boil and cook 20 minutes. Pay no attention to the foam; let it run over and go to waste. Draw off the liquid left after the cooking, then wash the crabs with cold water. Pick the meat, being careful to keep out all leg and claw joint shells; wash the picked meat in cold 1 per cent. brine (1 lb. salt to 12 $\frac{1}{2}$  gals. water), drain off all liquid and pack in enameled cans or plain cans lined with parchment paper; cap, leaving tip hole open; exhaust No. 1 cans 8 minutes, No. 2 cans 10 minutes; close tip hole and process.

No. 1 cans 20 minutes at 240 degrees, then 10 minutes at 250 degrees.

No. 2 cans 35 minutes at 240 degrees, then 15 minutes at 250 degrees.

After process time has expired, blow off retort and, without opening retort, turn in a stream of cold water through a properly introduced pipe at the top of retort, thus cooling the cans without direct exposure to the air. If cans are taken out of retort before cooling, the meat will darken to a greater or less extent in a short time.

### DEVILED CRAB MEAT.

- 1 lb. Butter or Butterine.
- 1 lb. Flour.
- 1 gal. Fresh Milk.
- 2 ozs. Chopped Parsley.
- 2 ozs. Onions, minced finely.
- 4 ozs. Salt.
- $\frac{1}{2}$  oz. Ground White Pepper.
- $\frac{1}{2}$  oz. Ground Red Pepper.

Place the butter in a suitable kettle and melt, add the flour and mix intimately, add the milk and while stirring constantly bring to a thorough boil, then add the salt and other ingredients; now add enough crab meat to make a mass of the proper consistency to fill in shells. Pack in cans while hot and process same time as crab meat.

### SOFT SHELL CRABS.

First Method.—Clean and prepare the live crabs, place in wire baskets of suitable size and cook same as hard crabs; place in cans, fill with hot 3 per cent. brine and process:

Half No. 1 cans 15 minutes at 240 degrees, then 8 minutes at 250 degrees.

No. 1 cans 20 minutes at 240 degrees, then 10 minutes at 250 degrees.

No. 2 cans 35 minutes at 240 degrees, then 15 minutes at 250 degrees.

Second Method.—Clean and prepare the crabs, place in wire baskets and plunge in boiling oil or lard for 5 minutes; provide the kettle with an extension top so that the oil will not overflow; pack the crabs in cans, fill in enough of the hot fat or oil to make a "bed," and proceed same time as above.

### FRESH WATER FISH.

Large or small may be treated, handled and processed same as salt water fish, except that the brine used must contain  $\frac{1}{2}$  to 1 per cent. of alum or some other hardening agent. Any suitable sauce—tomato, mustard, etc.—may be used in place of brine for filling cans.

### HERRING ROE.

Clean off adhering shreds and strings, wash in cold water, then soak two hours in 3 per cent. brine, drain and pack in No. 2 cans, exhaust 10 minutes, and process 60 minutes at 240 degrees.



### CLAMS (SOFT).

Handle same as oysters, exhaust 10 minutes at 212 degrees, process at 240 degrees 1-lb. cans 15 minutes, 2-lb. cans 20 minutes.

### QUAHAUGS (HARD CLAMS).

Handle same as oysters, exhaust 10 minutes at 212 degrees, and process at 240 degrees, 1-lb. cans 20 minutes, 2-lb. cans 25 minutes, 3-lb. cans 30 minutes.

### LOBSTERS.

Any of the following methods or a combination of them may be used in canning lobsters.

First Method of Cooking.—Plunge the live (only) lobsters in a tank of rapidly boiling water containing 2 to 3 per cent. salt, and cook 30 minutes; then chill in cold water.

Second Method.—Plunge in rapidly boiling water containing 3 per cent. solution bicarbonate soda and cook 15 minutes; draw off the solution and cover again with cold water acidulated with enough vinegar to neutralize the soda remaining in the lobster, and cook 15 minutes; then chill in cold water.

Third Method.—Kill the lobster by cutting it at the joint where the tail and body shell come together; then cook by either first or second method.

### CLEANING AND PICKING.

When cool enough to handle twist off claws and tail; split the tail underneath into halves and remove intestinals; open the body shell and take out liver and coral; take body from shell and remove stomach; crack claws and pick meat from these and shell, keeping all pieces large as possible. Mix a small proportion of salt (to taste) with the prepared meat, pack in No. 1 cans solidly, dividing the claw meat and larger pieces equally.

### CANS.

If plain tin is used, line top, bottom and sides with parchment paper to prevent the meat coming in direct contact with the tin, especially if the first method of cooking is employed.

By the second method of cooking the meat will not develop so much of the "tinny" flavor as will that cooked in plain, salted water.

Exhaust in steam until contents of cans show a temperature of 150 to 160 degrees, and process 1 hour at 250 degrees. Cool cans in cold water. Handle the hot cans gently as possible to avoid "matting" contents.

## OYSTERS.

In the factory plan before submitted it is intended that the steam box be placed outside of the building and be retained permanently in place, with the idea in mind of utilizing it not only for oysters, but also for beets and sweet potatoes during their season. If the wharf where the oysters are received is of sufficient size it may be roughly enclosed to contain the steam box and room for the shuckers; or the steam box may be placed in the open, and, after steaming, run the cars into the peeling-room, where the tracks, arranged with suitable switches or turntable, will occupy the portion of the room not occupied in pineapple and pea packing. The tracks may be so constructed as to have a gentle incline from the loading to the shucking point in order that the loaded cars may be more easily moved, but, unless the space is not otherwise used so that the tracks can remain permanently in place, it is preferable to have the tracks uniformly level.

When oysters are received in a muddy condition, it is best, though not necessary, to wash before steaming. When oysters are kept for any great length of time, either in cars or on the floor, wet them down once or twice a day with cold water; they will require this moistening oftener in warm than cold weather.

When ready to steam, run the loaded cars in steam box, close the doors and fasten the clamps opposite the hinges first; turn on steam until gauge marks 10 pounds pressure and maintain at this point 8 to 10 minutes (oysters well covered with mussels will require three to five minutes more) until the shells open readily; then exhaust steam and open doors by releasing the clamps nearest hinges first and those opposite last.

Require the shuckers to roughly sort the meats into two sizes, primes and selects, after which wash well in cold water and place on packing table, where, before putting in cans, remove all torn, broken and discolored oysters. If for any reason it is necessary to carry shucked steam oysters over night, cover them with cold water in which has been dissolved 1 per cent. bicarbonate soda.

Under certain weather conditions it may be advisable to can raw shucked oysters which have been prepared for future shipments. These should be first well washed in cold water, then given a bath in a 1 per cent. solution of bicarbonate soda, then plunged in boiling water until the gills curl, after which handle same as steamed stock.

The cans must be filled as full as practical with the oyster meat, and for this reason the Government has set the following weights as about what the cans will be expected to turn out after processing:



| Cans:    |              | Weight of drained<br>oysters, "cut out." |
|----------|--------------|------------------------------------------|
| Diameter | Height       |                                          |
| 2 11-16  | 2 3-4        | 3 ozs.                                   |
| 2 11-16  | 3 6-16       | 4 ozs.                                   |
| 2 11-16  | 4 No. 1      | 5 ozs.                                   |
| 3 3-8    | 3 15-16      | 8 ozs.                                   |
| 3 3-8    | 4 9-16 No. 2 | 10 ozs.                                  |

Weigh out the desired amount of meats, place in can, fill with brine ( $2\frac{1}{2}$  lbs. salt to  $12\frac{1}{2}$  gals. water), exhaust 10 minutes at 212 degrees, and process at 240 degrees No. 1 cans 12 to 14 minutes and No. 2 cans 14 to 17 minutes, according to weight of meat.

### SHRIMP.

When the shrimp are brought on the dock they are stored in ice until ready to use. The ice makes the peeling easier and is necessary to prevent spoilage. The removal of the head and shell is known as "peeling" the shrimp, and this is done for all canned shrimp. The head and thorax break from the heavy tail with ease, and a slight squeeze will separate the fleshy portion from the shell. This work is done rapidly. The pay for peeling is about 1c. per pound. The peeled shrimp are thoroughly washed in two or more changes of water and are then ready for blanching. The blanching consists in boiling the shrimp in salt water, which is done by suspending them in a wire basket in the boiling brine. The time of the blanch is usually about four minutes for the wet and five minutes for the dry pack. The salt in the brine is in the proportion of about 1 pound per gallon of water. Up to the time the shrimp go into the blanch they are white or slightly gray in color; the boiling in the brine causes them to become bright pink or red.

The shrimp are turned out upon trays having wire netting. As soon as cool they are filled into cans by hand, each can being weighed. The shrimp are all pecked in either No. 1 or No.  $1\frac{1}{2}$  cans, the former having 5 ounces for dry pack and  $5\frac{3}{4}$  ounces for wet pack and the latter  $8\frac{1}{4}$  ounces for dry and  $9\frac{3}{4}$  ounces for wet pack. There is no attempt at grading.

Shrimp are put up in what are known as dry and wet packs. In the dry pack no liquor is added, while in the wet pack brine is used. The process for dry shrimp is 1 hour at 240 degrees F. or 4 hours at 212 degrees F. for No. 1 cans, and 75 minutes at 240 degrees F. and 4 hours at 212 degrees F. for No.  $1\frac{1}{2}$  cans. The process for wet shrimp is 30 minutes for No. 1 and 40 minutes at 240 degrees F. for No.  $1\frac{1}{2}$  cans.

### GREEN TURTLE.

Hang the turtle up head downward, and with a sharp knife cut off the head close to the skull; allow to hang at least 12 hours for blood to drain out; separate the shells, being careful not to break gall bladder, which remove with the entrails, separate the green fat and reserve; boil the shells in water long enough to separate the bones, then scrape off the mucilage and reserve; put the head, fins, liver, lights and heart in the liquor in which the shells were cooked, and also the meat, enclosed in a cage; cook until meat is done, then divide the meat, green fat and mucilage equally among the desired number of cans, and fill with the strained liquor, in each gallon of which has been dissolved  $\frac{1}{2}$  lb. gelatine; cap, tip and process at 250 degrees, No. 1 cans 60 minutes, No. 2 cans 70 minutes.

### SNAPPING TURTLE.

Cut off head with a sharp hatchet, hang up by tail for 12 hours to drain out blood; wash and drop in boiling water until shells part easily; pull out toe nails, take off lower shell and remove gall, which be very careful not to break; remove the liver, heart and eggs, separate the flesh from upper shell and cut in pieces. Place the meat, including skin and legs, the heart, eggs and chopped liver, in kettle with just enough water to cover, and cook until skin is soft and jelly-like; then place in cans, dividing the white meat and eggs as evenly as possible; cap, tip and process at 250 degrees, No. 1 cans 55 minutes, No. 2 cans 65 minutes.

### STEWED SNAPPING TURTLE.

To 50 lbs. of snapper cooked ready to go in cans add 50 lbs. of meat jelly, 2 lbs. of salt, 2 oz. of ground white pepper, 1 oz. of ground cayenne pepper, 1 oz. of ground Saigon cinnamon; bring to a boil, shut off steam and add one-half gallon of sherry wine; place in cans, cap, tip and process at 250 degrees, No. 1 cans 55 minutes, No. 2 cans 60 minutes.

### STEWED TERRAPIN, DIAMOND BACKS OR RED LEGS.

Twenty-four terrapins,  $1\frac{1}{2}$  gals. cream, 6 dozen eggs, 10 lbs. butter, 1 lb. salt,  $1\frac{1}{2}$  oz. powdered mace, 1 oz. cayenne pepper, 12 pints of sherry wine. Plunge the live terrapin in boiling water and cook until the toe nails and outer skin come off readily; remove these and place terrapin in clear, salted boiling water until the legs are quite tender; then clean same as snapper, but keep the small intestines, which cut in very small pieces.



Place the cut-up meat, intestines, liver, eggs and liquor given out while cutting up in kettle, add the butter and heat until melted; then add the cream, seasoning and bring just to a boil; turn off steam and add the yolks of the eggs, previously hard boiled, mashed and creamed with the wine; place in cans, cap, tip and process No. 1 cans 50 minutes at 250 degrees.



# The National Pure Food Law

**An act for preventing the manufacture, sale or transportation of adulterated or misbranded or poisonous or deleterious foods, drugs, medicines and liquors, and for regulating traffic therein and for other purposes.**

*Be it enacted by the Senate and House of Representatives of the United States of America in Congress assembled,* That it shall be unlawful for any person to manufacture, sell, or offer for sale within any Territory or the District of Columbia, or deliver for shipment, or to cause to be delivered, shipped or transported from within any State, Territory, or District of Columbia to any State, Territory or District of Columbia, or foreign country, any article of food, drugs, medicines or liquors which is adulterated or misbranded, or which contains any poisonous or deleterious substance within the meaning of this Act; and any person who shall violate any of the provisions of this section shall be guilty of a misdemeanor, and for each offense shall, upon conviction thereof, be fined not to exceed five hundred dollars or shall be sentenced to one year's imprisonment, or both such fine and imprisonment, in the discretion of the court, and for each subsequent offense and conviction thereof shall be fined not less than one thousand dollars or sentenced to one year's imprisonment, or both such fine and imprisonment, in the discretion of the court.

SEC. 2. That the introduction into any State or Territory or the District of Columbia from any other State or Territory or the District of Columbia, or from any foreign country, or shipment to any foreign country of any article of food or drugs which is adulterated or misbranded, within the meaning of this Act, is hereby prohibited; and any person who shall ship or deliver for shipment from any State or Territory or the District of Columbia to any other State or Territory or the District of Columbia, or to a foreign country, or who shall receive in any State or Territory or the District of Columbia from any other State or Territory or District of Columbia, or foreign country, and having so received, shall deliver, in original unbroken packages, for pay or otherwise, or offer to deliver to any other person any such article so adulterated or misbranded within the meaning of this Act, or any person who shall sell or offer for sale in the District of Columbia or the Territories of the United States any such adulterated or misbranded foods or drugs, or offer to export the same to any foreign country, shall be guilty of a misdemeanor, and for such offense be fined not exceeding two hundred dollars for the first offense, and upon conviction for each subsequent offense not exceeding three hundred dollars or be imprisoned not exceeding one year, or both, in the discretion of the court. Provided, That no article shall be deemed misbranded or adulterated within the provision of this Act when intended for export to any foreign country and prepared or packed according to the specifications or directions of the foreign purchaser when no substance is used in the preparation or packing thereof in conflict with the laws of the foreign country to which said article is intended to be shipped; but if said article shall be in fact sold or offered for sale for domestic use or consumption, then this proviso shall not exempt said article from the operation of any of the other provisions of this Act.



## UNIFORM RULES BY VARIOUS AUTHORITIES.

SEC. 3. That the Secretary of the Treasury, the Secretary of Agriculture and the Secretary of Commerce and Labor make uniform rules and regulations for carrying out the provisions of this Act, including the collection and examination of specimens of foods and drugs manufactured or offered for sale in the District of Columbia, or in any Territory of the United States, or which shall be offered for sale in unbroken packages in any State other than that in which they shall have been respectively manufactured or produced, or which shall be received from any foreign country, or intended for shipment to any foreign country, or which may be submitted for examination by the chief health food or drug officer of any State, Territory or the District of Columbia, or at any domestic or foreign port through which such product is offered for interstate commerce, or for export or import between the United States and any foreign port or country.

SEC. 4. That the examination of specimens of foods and drugs shall be made in the Bureau of Chemistry of the Department of Agriculture, or under the direction and supervision of such bureau for the purpose of determining from such examinations whether such articles are adulterated or misbranded within the meaning of this Act; and if it shall appear from any such examination that any such specimens are adulterated or misbranded within the meaning of this Act, the Secretary of Agriculture shall cause notice thereof to be given to the party from whom such sample was obtained. Any party so notified will be given an opportunity to be heard, under such rules and regulations as may be prescribed as aforesaid, and if it appears that any of the provisions of this Act have been violated by such party, then the Secretary of Agriculture shall at once certify the facts to the proper United States district attorney, with a copy of the results of the analysis or the examination of such article duly authenticated by the analyst or officer making such examination, under oath of such officer. After judgment of the court, notice shall be given by publication in such manner as may be prescribed by the rules and regulations aforesaid.

SEC. 6. That the term "drug," as used in this act, shall include all medicines and preparations recognized in the United States Pharmacopœia or National Formulary for internal or external uses, and any substance or mixture of substances intended to be used for the cure, mitigation or prevention of disease of either man or other animals. The term "food," as used herein, shall include all articles used for food, drink, confectionery or condiment by man or other animals, whether simple, mixed or compounded.

## WHEN ARTICLE SHALL BE DEEMED ADULTERATED.

SEC. 7. That for the purpose of this Act an article shall be deemed to be adulterated:

## IN CASE OF DRUGS:

First. If, when a drug is sold under or by a name recognized in the United States Pharmacopœia or National Formulary, it differs from the standard of strength, quality or purity, as determined by the test laid down in the United States Pharmacopœia or National Formulary official at the time of investigation. Provided, That no drug defined in the United States Pharmacopœia or National Formulary shall be deemed to be adulterated under the provision if the standard of strength, quality or purity be plainly stated upon the bottle, box or other container thereof, although the standard may differ from that determined by the test laid down in the United States Pharmacopœia or National Formulary.

Second. If this strength or purity fall below the professed standard or quality under which it is sold.

## IN THE CASE OF CONFECTIONERY:

If it contains terra alba, barytes, talc, chrome yellow, or other mineral substance or poisonous color or flavor, or other ingredient deleterious or detrimental to health, or any vinous, malt or spirituous liquor or compound or narcotic drug.

## IN THE CASE OF FOOD:

First. If any substance has been mixed and packed with it so as to reduce or lower or injuriously affect its quality or strength.

Second. If any substance has been substituted wholly or in part for the article.

Third. If any valuable constituent of the article has been wholly or in part abstracted.

Fourth. If it be mixed, colored, powdered, coated or stained in a manner whereby damage or inferiority is concealed.

Fifth. If it contain any added poisonous or other added deleterious ingredient which may render such article injurious to health. Provided, That when in the preparation of food products for shipment they are preserved by an external application applied in such manner that the preservative is necessarily removed mechanically, or by maceration, in water or otherwise, and directions for the removal of said preservative shall be printed on the covering or the package, the provisions of this Act shall be construed as applying only when said products are ready for consumption.

Sixth. If it consists in whole or in part of a filthy, decomposed or putrid animal or vegetable substance, or any portion of an animal unfit for food whether manufactured or not, or if it is the product of a diseased animal, or one that has died otherwise than by slaughter.

SEC. 8. That the term "misbranded," as used herein, shall apply to all drugs or articles of food, or articles which enter into the composition of food, the package or label of which shall bear any statement, design or device regarding such article, or the ingredients or substances contained therein shall be false or misleading in any particular, and to any food or drug product which is falsely branded as to the State, Territory or country in which it is manufactured or produced.

## WHEN ARTICLES SHALL BE DEEMED MISBRANDED.

That for the purpose of this Act an article also shall be deemed to be misbranded:

## IN CASE OF DRUGS:

First. If it be an imitation of or offered for sale under the name of another article.

Second. If the contents of the package as originally put up shall have been removed, in whole or in part, and other contents shall have been placed in such package, or if the package fail to bear a statement on the label of the quantity or proportion of any alcohol, morphine, opium, cocaine, heroine, alpha or beta eucaine, chloroform, cannabis indica, chloral hydrate or acetanilid, or any derivative or preparation of any substances contained therein.

## IN CASE OF FOOD:

First. If it be an imitation of or offered for sale under the distinctive name of another article.

Second. If it be labeled or branded so as to deceive or mislead the purchaser, or purport to be a foreign product when not so, or if the contents of



the package as originally put up shall have been removed in whole or in part and other contents shall have been placed in such package, or if it fail to bear a statement on the label of the quantity or proportion of any morphine, opium, cocaine, heroine, alpha or beta eucaine, chloroform, cannabis, indica, chloral, hydrate or acetanilid, or any derivative or preparation of any such substances contained therein.

Third. If in package form and the contents are stated in terms of weight or measure, they are not plainly and correctly stated on the outside of the package.

(See Weight or Measure Branding Laws at back of this book.)

Fourth. If the package containing it or its label shall bear any statement, design or device regarding the ingredients of the substances contained therein, which statement, design or device shall be false or misleading in any particular. Provided, That an article of food which does not contain any added poisonous or deleterious ingredients shall not be deemed to be adulterated or misbranded in the following cases:

First. In the case of mixtures or compounds which may be now or from time to time hereafter known as articles of food, under their own distinctive names, and not an imitation of or offered for sale under the label or brand with a statement of the place where said article has been manufactured or produced.

Second. In the case of articles labeled, branded or tagged, so as to plainly indicate that they are compounds or blends, and the word "compound," "imitation" or "blend," as the case may be, is plainly stated on the package in which it is offered for sale. Provided, That the term blend as used herein shall be construed to mean a mixture of like substances, not excluding harmless coloring or flavoring ingredients used for the purpose of coloring and flavoring only. And provided further, That nothing in this Act shall be construed as requiring or compelling proprietors or manufacturers of proprietary foods which contain no unwholesome added ingredient to disclose their true formulas, except in so far as the provisions of this Act may require to secure freedom from adulteration or misbranding.

#### THE GUARANTY.

SEC. 9. That no dealer shall be prosecuted under the provisions of this Act when he can establish a guaranty signed by the wholesaler, jobber, manufacturer or other party residing in the United States from whom he purchases such articles to the effect that the same is not adulterated or misbranded within the meaning of this Act, designating it. Said guaranty, to afford protection, shall contain the name and address of the party or parties making the sale of such articles to such dealer, and in such case said party or parties shall be amenable to the prosecutions, fines and other penalties which would attach, in due course, to the dealer under the provision of this Act.

SEC. 10. That any article of food, drug or liquor that is adulterated or misbranded within the meaning of this Act and is being transported from one State, Territory, District of Columbia or insular possession to another for sale, or having been transported, remains unloaded, unsold, or in original unbroken packages, or if it be sold or offered for sale in the District of Columbia, or in the Territories or insular possessions of the United States; or if it be imported from a foreign country for sale, or if it be intended for export to a foreign country, shall be liable to be proceeded against in any district court of the United States within the District where the same is found and seized for confiscation by a process of libel for condemnation. And if such article is condemned as being adulterated or misbranded, or of a poisonous or deleterious character, within the meaning of this Act, the same

shall be disposed of by destruction or sale, as the said court may direct, and the proceeds thereof, if sold, less the legal cost and charges, shall be paid into the Treasury of the United States, but such goods shall not be sold in any jurisdiction contrary to the provisions of this Act or the laws of that jurisdiction. Provided, however, that upon the payment of the costs of such libel proceedings and the execution and delivery of a good and sufficient bond to the effect that such articles shall not be sold or otherwise disposed of contrary to the provisions of this Act or the laws of any State, Territory, District of Columbia or insular possession, the court may by order direct that such articles be delivered to the owner thereof. The proceedings of such libel cases shall conform, as near as may be, to the proceedings in admiralty, except that either party may demand trial by jury of any issue of fact joined in any such case, and all such proceedings shall be at the suit of and in the name of the United States.

#### DELIVERY OF SAMPLES OF IMPORTED GOODS.

SEC. 11. The Secretary of the Treasury shall deliver to the Secretary of Agriculture, upon his request from time to time, samples of foods and drugs which are being imported into the United States or offered for import, giving notice thereof to the owner or consignee, who may appear before the Secretary of Agriculture and have the right to introduce testimony, and if it appears from the examination of such samples that any article of food or drug offered to be imported into the United States is adulterated or misbranded within the meaning of this Act, or is otherwise dangerous to the health of the people of the United States, or is of a kind forbidden entry into or forbidden to be sold or restricted in sale in the country in which it is made or from which it is exported, or is otherwise falsely labeled in any respect, the said article shall be refused admission, and the Secretary of the Treasury shall refuse delivery to the consignee and shall cause the destruction of any goods refused delivery which shall not be exported by the consignee within three months from the date of notice of such refusal under such regulations as the Secretary of the Treasury may prescribe. Provided, That the Secretary of the Treasury may deliver to the consignee such goods pending the examination and decision in the matter on execution of a penal bond for the amount of the full invoice value of such goods, together with the duty thereon, and on refusal to return such goods for any cause to the custody of the Secretary of the Treasury, when demanded, for the purpose of excluding them from the country, or for any other purpose, said consignee shall forfeit the full amount of the bond. And provided further, that all charges for storage, cartage and labor on goods which are refused admission or delivery shall be paid by the owner or consignee, and in default of such payment shall constitute a lien against any future importation made by such owner or consignee.

SEC. 12. That the term "Territory" as used in this act shall include the insular possessions of the United States. The word "person" as used in this Act shall be construed to impart both the plural and singular, as the case demands, and shall include corporations, companies, societies and associations. When construing and enforcing the provisions of this Act, the act, omissions or failure of any officer, agent or other person acting for or employed by any corporation, company, society or association within the scope of his employment or office, shall in every case be also deemed to be the act, omission or failure of such corporation, company, society or association, as well as that of the person.

SEC. 13. That this Act shall be in force and effect from and after the first day of January, nineteen hundred and seven.



# Weight or Measure Branding Laws

---

## NATIONAL.

The amendment of March 3, 1913, to the food and drugs act of June 30, 1906, provides that food in package form must be labeled to show the quantity of contents in terms of weight, measure or numerical count. The regulations for the enforcement of this amendment are now being formulated.

## CALIFORNIA.

The Act 1913, chapter 167, provides that all food products sold in a container must be labeled to show the weight, measure or numerical count of contents. The law defines a container to be the receptacle in which the commodity is packed for sale or expose sale. Designation shall be in weight, measure or count, as is most feasible according to the character of the product, and if by weight must be in terms of pounds, ounces or fractions avoirdupois; if by liquid measure, in terms of gallons, quarts, pints or fractions thereof; and if by solid measure, in terms of bushels, pecks, quarts or fractions thereof; if by count, shall be expressed in English words of Arabic numerals. In stating the contents, one of the following phrases shall appear: "Net Contents," "Net Weight," "Net Measure," or "Net Count." Unavoidable discrepancies are not to be held a violation of the Act, nor is it a violation, if there is a discrepancy, provided the seller of the article purchased the container in good faith, relying upon the statement of the contents in the container; provided, further, that the name of the packer, manufacturer, wholesaler or jobber appears upon the container.

This law took effect April 1st, 1914.

## CONNECTICUT.

The Connecticut law now in effect requires all food products in package form, except confectionary and shelled nuts, sold for 10 cents or less, to be labeled to show the weight, measure or numerical count, with allowance for reasonable variations, under rules and regulations made from time to time by the dairy and food commissioner and the director of the Connecticut experiment station.

This law is now in effect, and by a ruling of the courts the term "package" has been construed to cover such things as cases of bottles. Therefore, under the Connecticut law, canned foods designated for sale in that State should be marked or stenciled in a way to show the net contents of the cans enclosed.

## FLORIDA.

Under the law now in effect it is necessary to state the weight, measure or numerical count of contents on all food products sold in package form. Reasonable variations are permitted. The regulations provide that the net weight shall be stated in pounds or ounces, avoirdupois, and that the net measure shall be stated in U. S. standard gallons, quarts or fluid ounces. Packages

containing more than a pound shall state the weight in pounds and ounces; weights less than a pound shall be stated in ounces. It is not permissible to state a pound or more in ounces or one quart or more in fluid ounces.

#### IOWA.

The act taking effect September 3, 1914, requires that food products in package form shall be labeled to show the weight, measure or numerical count of contents. Reasonable variations are permitted.

#### MAINE.

Under the Maine law canned foods must be labeled to show the quantity of contents in terms of weight, measure or numerical count. Reasonable variations are permitted.

#### MICHIGAN.

Food products in package form are required to bear upon the principal label a statement of the true net weight in terms of pounds, ounces and grains avoirdupois, or true net measure, in terms of gallons of 231 cu. in., or fractions thereof, and quarts, pints and gills, or true numerical count. Reasonable variations are permitted.

#### MONTANA.

All commodities, including food products in package or container when sold or offered for sale, must be labeled with a correct statement of the weight, measure or numerical count. In determining whether or not the correct weight is stated, the usual leakage, evaporation or waste shall be taken into consideration. A variation of 3 per cent. from the stated weight is allowed, provided the variation is as often above as below the weight stated. These provisions took effect January 1st, 1914.

#### NEBRASKA.

All food products in package form must be labeled to show the weight, measure or numerical count of the contents. Reasonable variations are permitted with the same proviso as in the Montana law.

#### NEVADA.

All commodities in package form, including food products, must be labeled with the weight, measure or numerical count of the contents. A slight variation is permissible when the same is as often above as below the weight stated, and the ordinary evaporation, leakage or waste shall be considered in determining whether or not the statement of weight is true.

#### NEW HAMPSHIRE.

The Act dated November 22, 1914, requires all food products in package form to be labeled to show the weight, measure or numerical count of contents. Reasonable variations are permitted.

#### NEW YORK.

All commodities sold in containers must be labeled to show the weight, measure or numerical count. Reasonable variations are permitted. The size of type to be used in marking the weight is prescribed by regulation, as follows: In type at least 1-9 inch in height where the weight of contents is in  $\frac{1}{4}$  lb.,  $\frac{1}{2}$  lb. or multiples of  $\frac{1}{2}$  lb.; otherwise in type at least 3-16 of an inch in height. The statute went into effect February 1, 1914.



## NORTH DAKOTA.

All food products in package form must be labeled with the weight. Reasonable variations are permitted.

## OREGON.

Food products in package form must be labeled to show the weight, measure or numerical count. Variations are permitted. The statute took effect July 1, 1914.

## PENNSYLVANIA.

The law approved by the Governor about July 24, 1913, provides that every commodity or article of food packed in containers of any description shall bear a plainly legible statement of the net weight, measure or numerical count of contents or of the net volume thereof, and the name and address of the manufacturer, producer or distributor. Reasonable variations to be established by the Chief of the Bureau of Standards are permitted.

## SOUTH DAKOTA.

The law now in effect provides that all food products sold in package form, bottle or container must be labeled to show the weight, measure or numerical count. Variations are permitted.

## UTAH.

All food products in packages must be labeled with the weight, measure or numerical count. Reasonable variations are permitted. This law was passed in 1913.

## WISCONSIN.

Foods in package form must be labeled to show the weight, measure or numerical count. Reasonable variations are permitted. This act took effect September 3, 1914.

## WYOMING.

Food products in package form must be labeled with the weight, measure or numerical count. Reasonable variations are permitted.



## CANNED FOODS WEIGHTS

Suggested arbitrary weights of contents to be used on labels to comply with the various State and National pure food laws, as approved by the Conference Committee of the National Wholesale Grocers' Association and the National Cannery Association.

The following weights allow for reasonable tolerances; in other words, cans reasonably well filled will weigh more than the weight expressed below. The following legend is recommended:

"Contents" to be expressed...Lbs...Oz.

|                                                     | No. | Lbs. | Ozs. |                          | No. | Lbs. | Ozs. |
|-----------------------------------------------------|-----|------|------|--------------------------|-----|------|------|
| Apples .....                                        | 2½  | 1    | 10   | Blackberries, H. S.....  | 2   | 1    | 5    |
| "    4 <sup>7</sup> / <sub>8</sub> ".....           | 3   | 1    | 13   | "    Water .....         | 2   | 1    | 3    |
| "    5".....                                        | 3   | 1    | 14   | "    H. S.....           | 2½  | 1    | 14   |
| "    5½".....                                       | 3   | 2    | 3    | "    .....               | 3   | 1    | 13   |
| "    .....                                          | 8   | 5    | 6    | "    .....               | 10  | 6    | 8    |
| "    .....                                          | 10  | 5    | 14   | Blueberries, H. S.....   | 2   | 1    | 4    |
| Apple Butter.....                                   | 1   | 0    | 11   | "    Water .....         | 2   | 1    | 3    |
| "    .....                                          | 2   | 1    | 4    | "    .....               | 10  | 6    | 12   |
| "    .....                                          | 2½  | 1    | 14   | Cabbage .....            | 3   | 2    | 0    |
| "    4 <sup>7</sup> / <sub>8</sub> ".....           | 3   | 2    | 1    | California Fruits—       |     |      |      |
| "    5".....                                        | 3   | 2    | 2    | Extra (Tall).....        | 1   | 1    | 0    |
| Apple Sauce.....                                    | 2½  | 1    | 13   | Extra Stand. (Tall)..... | 1   | 0    | 15   |
| "    .....                                          | 2   | 1    | 4    | Second (Tall).....       | 1   | 0    | 15   |
| "    .....                                          | 10  | 6    | 11   | Extra (Flat).....        | 1   | 0    | 15   |
| Asparagus (Rd. Salmon).....                         | 1   | 1    | 0    | Second (Flat).....       | 1   | 0    | 14   |
| "    Square .....                                   | 1   | 1    | 0    | Standards (Flat)....     | 1½  | 0    | 14   |
| "    Flat or Round 1½                               | 1   | 2    |      | Extra .....              | 1½  | 1    | 1    |
| "    Round .....                                    | 2   | 1    | 3    | Second .....             | 1½  | 1    | 0    |
| "    Square .....                                   | 2½  | 1    | 15   | Extra .....              | 2½  | 1    | 14   |
| "    Round .....                                    | 3   | 2    | 0    | Extra Standard.....      | 2½  | 1    | 14   |
| "    Square .....                                   | 3   | 2    | 10   | Standards .....          | 2½  | 1    | 14   |
| "    .....                                          | 8   | 6    | 2    | Seconds .....            | 2½  | 1    | 12   |
| "    .....                                          | 10  | 6    | 4    | Water .....              | 2½  | 1    | 12   |
| Beans (Wax & Refugee).....                          | 1   | 0    | 11   | Pie .....                | 2½  | 1    | 12   |
| "    "    .....                                     | 1½  | 0    | 14   | Extra, 5".....           | 3   | 2    | 4    |
| "    "    .....                                     | 2   | 1    | 3    | Extra Standards....      | 8   | 6    | 8    |
| "    "    4 <sup>7</sup> / <sub>8</sub> ".....      | 3   | 1    | 15   | Water .....              | 8   | 6    | 4    |
| "    "    5".....                                   | 3   | 2    | 0    | Pie .....                | 8   | 6    | 4    |
| "    "    .....                                     | 8   | 6    | 2    | Extra .....              | 10  | 6    | 14   |
| "    "    .....                                     | 10  | 6    | 6    | Water .....              | 10  | 6    | 6    |
| Beans (Red Kidney)....                              | 1   | 0    | 11   | Cauliflower .....        | 3   | 2    | 2    |
| "    "    .....                                     | 2   | 1    | 4    | Cherries, H. S.....      | 2   | 1    | 5    |
| "    "    4 <sup>7</sup> / <sub>8</sub> ".....      | 3   | 2    | 0    | "    Water .....         | 2   | 1    | 3    |
| "    "    .....                                     | 10  | 6    | 11   | "    H. S.....           | 2½  | 1    | 15   |
| Beans (Lima).....                                   | 1   | 0    | 11   | "    .....               | 10  | 6    | 9    |
| "    "    .....                                     | 1½  | 0    | 14   | Chile Con Carne.....     | 1   | 0    | 10   |
| "    "    .....                                     | 2   | 1    | 4    | Clam Chowder.....        | 3   | 2    | 1    |
| "    "    .....                                     | 10  | 6    | 11   | Clams .....              | 1   | 0    | 5    |
| Beans (Baked).....                                  | 1   | 0    | 11   | "    .....               | 2   | 0    | 10   |
| "    "    .....                                     | 2   | 1    | 5    | Corn .....               | 1   | 0    | 11   |
| "    "    .....                                     | 2½  | 1    | 15   | "    .....               | 2   | 1    | 4    |
| "    "    4 <sup>7</sup> / <sub>8</sub> ".....      | 3   | 2    | 2    | "    .....               | 10  | 6    | 8    |
| "    "    .....                                     | 10  | 6    | 14   | Currants .....           | 10  | 6    | 10   |
| Beans and Pork.....                                 | 1   | 0    | 11   | Figs .....               | ¾   | 0    | 11   |
| "    "    "    .....                                | 2   | 1    | 5    | "    .....               | 1½  | 1    | 3    |
| "    "    "    .....                                | 2½  | 1    | 15   | Gooseberries, H. S.....  | 1   | 0    | 13   |
| "    "    "    4 <sup>7</sup> / <sub>8</sub> "..... | 3   | 2    | 2    | "    Water .....         | 1   | 0    | 11   |
| "    "    "    .....                                | 10  | 6    | 14   | "    H. S.....           | 2   | 1    | 5    |
| Beets .....                                         | 2   | 1    | 4    | "    Water .....         | 2   | 1    | 3    |
| "    .....                                          | 3   | 2    | 1    | "    H. S.....           | 2½  | 2    | 0    |
| "    .....                                          | 10  | 6    | 10   | "    .....               | 10  | 6    | 7    |



CANNED FOODS WEIGHTS—Continued

|                        | No. | Lbs. | Ozs. |                           | No. | Lbs. | Ozs. |
|------------------------|-----|------|------|---------------------------|-----|------|------|
| Hominy                 | 2½  | 1    | 15   | Pumpkin                   | 2   | 1    | 3    |
| " 4⅞"                  | 3   | 2    | 1    | "                         | 2½  | 1    | 14   |
| " 5½"                  | 3   | 2    | 6    | " 4⅞"                     | 3   | 2    | 1    |
| "                      | 10  | 6    | 11   | " 5"                      | 3   | 2    | 2    |
| Lobsters               | ¼   | 0    | 3¼   | " 5½"                     | 3   | 2    | 5    |
| "                      | ½   | 0    | 7½   | "                         | 10  | 6    | 8    |
| "                      | ¾   | 0    | 9½   | Prunes                    | 2   | 1    | 4    |
| "                      | 1   | 0    | 15   | Raspberries, H. S.        | 2   | 1    | 5    |
| Loganberries, H. S.    | 2   | 1    | 5    | " Water                   | 2   | 1    | 3    |
| "                      | 10  | 6    | 4    | " H. S.                   | 2½  | 1    | 14   |
| Milk (Evaporated) Baby | 0   | 6    |      | "                         | 10  | 6    | 10   |
| " " Family             | 0   | 12   |      | Rhubarb                   | 2½  | 1    | 15   |
| " " Tall               | 1   | 0    |      | "                         | 10  | 6    | 4    |
| " " Hotel              | 2   | 0    |      | Salmon (Tall, Flat, Oval) | 1   | 1    | 0    |
| " " Confectioners      | 8   | 0    |      | "                         | ½   | 0    | 8    |
| Okra                   | 2   | 1    | 3    | Sardines                  | ¼   | 0    | 3½   |
| "                      | 3   | 2    | 1    | "                         | ¾   | 0    | 11   |
| "                      | 10  | 6    | 7    | Sauer Kraut               | 2   | 1    | 3    |
| Okra and Tomatoes      | 2   | 1    | 3    | " "                       | 2½  | 1    | 13   |
| "                      | 3   | 2    | 1    | " " 4⅞"                   | 3   | 2    | 0    |
| Oysters, 2 11/16x2¾    | 0   | 3    |      | " " 5½"                   | 3   | 2    | 4    |
| " 2 11/16x3 6/16       | 0   | 4    |      | "                         | 10  | 6    | 4    |
| " 2 11/16x4            | 1   | 0    | 5    | Shrimp (Wet and Dry)      | 1   | 0    | 4½   |
| " 3⅜x3 5/16            | 0   | 6    |      | " " "                     | 1½  | 0    | 8½   |
| " 3⅜x3 15/16           | 0   | 8    |      | Soups                     | 1   | 0    | 10½  |
| " 3⅜x4 9/16            | 2   | 0    | 10   | "                         | 10  | 7    | 0    |
| Peaches, H. S.         | 1   | 0    | 10   | Spaghetti                 | 1   | 0    | 11   |
| " Sliced (Flat)        | 1¼  | 0    | 14   | "                         | 2   | 1    | 5    |
| " H. S. (Flat)         | 1½  | 1    | 3    | Spinach                   | 2   | 1    | 2    |
| " H. S.                | 2   | 1    | 4    | "                         | 2½  | 1    | 9    |
| " Water                | 2   | 1    | 3    | " 4⅞"                     | 3   | 1    | 14   |
| " Water                | 2½  | 1    | 12   | " 5"                      | 3   | 1    | 15   |
| " Water, 4⅞"           | 3   | 1    | 15   | " 5½"                     | 3   | 2    | 4    |
| " H. S.                | 2½  | 1    | 14   | "                         | 10  | 6    | 4    |
| " H. S., 4⅞"           | 3   | 2    | 1    | Squash, 4⅞"               | 3   | 2    | 1    |
| "                      | 10  | 6    | 6    | "                         | 10  | 6    | 9    |
| Peach Butter           | 2   | 1    | 4    | Strawberries, H. S.       | 1   | 0    | 11   |
| Pears, H. S.           | 2   | 1    | 4    | " H. S.                   | 2   | 1    | 4    |
| " Water                | 2   | 1    | 3    | " H. S.                   | 2½  | 1    | 12   |
| " H. S.                | 2½  | 1    | 14   | "                         | 10  | 6    | 4    |
| " H. S. 4⅞"            | 3   | 2    | 1    | Succotash                 | 1   | 0    | 11   |
| "                      | 10  | 6    | 8    | "                         | 2   | 1    | 4    |
| Peas                   | 1   | 0    | 11   | "                         | 10  | 6    | 9    |
| "                      | 1½  | 0    | 15   | Sweet Potatoes            | 2½  | 1    | 12   |
| "                      | 2   | 1    | 4    | " " 4⅞"                   | 3   | 1    | 15   |
| "                      | 10  | 6    | 12   | " " 5"                    | 3   | 2    | 0    |
| Pineapple (Buffet)     | 1   | 0    | 9    | "                         | 10  | 6    | 4    |
| " (Flat)               | 2   | 1    | 2    | Tomatoes                  | 1   | 0    | 10   |
| " (Tall)               | 2   | 1    | 5    | "                         | 1½  | 0    | 13   |
| " (Baltimore)          | 2   | 1    | 4    | "                         | 2   | 1    | 3    |
| " (Sliced)             | 2½  | 1    | 14   | " 4⅞"                     | 3   | 2    | 1    |
| " (Grated) 4⅞"         | 3   | 1    | 15   | " 5"                      | 3   | 2    | 2    |
| "                      | 8   | 6    | 0    | " 5½"                     | 3   | 2    | 6    |
| Plums, H. S.           | 2   | 1    | 4    | "                         | 8   | 6    | 4    |
| " H. S.                | 2½  | 1    | 14   | "                         | 10  | 6    | 7    |
| " Water                | 2½  | 1    | 12   | Tuna Fish                 | ¼   | 0    | 3½   |
| " H. S. 4⅞"            | 3   | 2    | 1    | " "                       | ½   | 0    | 7    |
| "                      | 10  | 6    | 6    | " "                       | 1   | 0    | 14   |

# CONTENTS

|                                          | Page |
|------------------------------------------|------|
| A Brief History of Canning.....          | 7    |
| Acreage Contracts.....                   | 69   |
| Acreage Necessary.....                   | 17   |
| Allspice Extract.....                    | 209  |
| Almond Extract.....                      | 209  |
| Altitude Sterilization Table.....        | 47   |
| Amount of Pork per can.....              | 81   |
| Anti-mold . . . . .                      | 183  |
| Anise Extract.....                       | 209  |
| Apple Butter . . . . .                   | 182  |
| Apple Jelly . . . . .                    | 186  |
| Apple Juice . . . . .                    | 174  |
| Apples, canned . . . . .                 | 127  |
| Apricots, canned.....                    | 128  |
| Apricots, candied.....                   | 168  |
| Asparagus Canning.....                   | 77   |
| Asparagus Plants per Acre.....           | 19   |
| Asparagus Seed Required per Acre.....    | 19   |
| Asparagus Soup.....                      | 154  |
| Baked Beans.....                         | 78   |
| Banana Extract, imitation.....           | 209  |
| Barley Soup.....                         | 152  |
| Beans, dried, grades.....                | 79   |
| Beans, Lima.....                         | 84   |
| Bean Seed Required to Plant an Acre..... | 19   |
| Bean Soup . . . . .                      | 152  |
| Beans, baked or processed.....           | 80   |
| Beans, pickled . . . . .                 | 218  |
| Beans, red kidney . . . . .              | 85   |
| Beans, string . . . . .                  | 85   |
| Beans, wax . . . . .                     | 86   |
| Beef, boiled . . . . .                   | 139  |
| Beef Cannelon . . . . .                  | 140  |
| Beef, corned . . . . .                   | 140  |
| Beef, pressed . . . . .                  | 141  |
| Beef, potted . . . . .                   | 143  |
| Beef, roasted . . . . .                  | 140  |
| Beef Stew . . . . .                      | 141  |
| Beef's Tongue . . . . .                  | 143  |
| Beets, canned . . . . .                  | 86   |
| Beet Seed Required to Plant an Acre..... | 19   |



|                                                  | Page |
|--------------------------------------------------|------|
| Birds, game . . . . .                            | 147  |
| Bitter Almond Extract . . . . .                  | 209  |
| Blackberries, canned . . . . .                   | 128  |
| Blackberries, candied . . . . .                  | 168  |
| Blackberries, preserved . . . . .                | 173  |
| Blanching Vegetables . . . . .                   | 74   |
| Blueberries, canned . . . . .                    | 129  |
| Boiled Beef, canned . . . . .                    | 139  |
| Boiler Capacity of Power Plant . . . . .         | 35   |
| Bouillon . . . . .                               | 151  |
| Boxing of Cans . . . . .                         | 69   |
| Brandied Fruits . . . . .                        | 181  |
| Branding (labeling) Laws . . . . .               | 237  |
| Brines, the Making of . . . . .                  | 74   |
| Brussels Sprouts . . . . .                       | 87   |
| Butters, fruit . . . . .                         | 182  |
| Cabbage, Boiled . . . . .                        | 87   |
| Cabbage Seed Required to Plant an Acre . . . . . | 19   |
| Calcium Processing . . . . .                     | 46   |
| California Grading, fruits . . . . .             | 125  |
| Candied Fruits . . . . .                         | 168  |
| Candied Tomatoes . . . . .                       | 170  |
| Can Markers or Stampers . . . . .                | 44   |
| Canning of Peas, The . . . . .                   | 97   |
| Cans, Number in a Car . . . . .                  | 36   |
| Cans, Open Top Equipment . . . . .               | 30   |
| Can Sizes . . . . .                              | 36   |
| Cans, Storage of . . . . .                       | 37   |
| Capital Required . . . . .                       | 20   |
| Car of Cans, Contents . . . . .                  | 36   |
| Catsup Spice Mixtures . . . . .                  | 217  |
| Catsups . . . . .                                | 196  |
| Cauliflower . . . . .                            | 87   |
| Cauliflower, pickled . . . . .                   | 218  |
| Celery . . . . .                                 | 87   |
| Celery Pulp for Soup . . . . .                   | 88   |
| Celery for Salads, etc . . . . .                 | 88   |
| Celery Seed Extract . . . . .                    | 209  |
| Celery Soup . . . . .                            | 154  |
| Celery Soup, condensed . . . . .                 | 154  |
| Cherries, canned . . . . .                       | 129  |
| Cherries, candied . . . . .                      | 168  |
| Cherries, preserved . . . . .                    | 173  |
| Cherries, preserved, hot process . . . . .       | 173  |
| Cherry Jelly . . . . .                           | 186  |
| Chicken Gumbo Soup . . . . .                     | 153  |

|                                               | Page |
|-----------------------------------------------|------|
| Chicken Gumbo Soup, condensed . . . . .       | 153  |
| Chicken in Jelly . . . . .                    | 146  |
| Chicken, potted . . . . .                     | 144  |
| Chicken, roasted . . . . .                    | 145  |
| Chicken Soup . . . . .                        | 153  |
| Chicken Soup, condensed . . . . .             | 153  |
| Chicken, stewed . . . . .                     | 145  |
| Chow-Chow Dressings . . . . .                 | —    |
| "C. H. P." Beans . . . . .                    | 79   |
| Cider Jelly . . . . .                         | 186  |
| Cinnamon Extract . . . . .                    | 209  |
| Citron, candied for mincemeat . . . . .       | 168  |
| Citron, pickled . . . . .                     | 218  |
| Clam Chowder . . . . .                        | 160  |
| Clam Chowder, condensed . . . . .             | 161  |
| Clam Soup . . . . .                           | 154  |
| Clams, hard . . . . .                         | 227  |
| Clams, soft . . . . .                         | 227  |
| Cleanliness of Workers . . . . .              | 24   |
| Clean Tomato Cannery . . . . .                | 115  |
| Cloves Extract . . . . .                      | 210  |
| Coagulants, or jellying acids . . . . .       | 183  |
| Composition of Canned Tomatoes . . . . .      | 121  |
| Compound Fruit-Butter . . . . .               | 182  |
| Compound Preserves . . . . .                  | 178  |
| Condensed Milk . . . . .                      | 148  |
| Condensed Soups . . . . .                     | 149  |
| Condition of Workers . . . . .                | 29   |
| Consomme . . . . .                            | 151  |
| Consomme, condensed . . . . .                 | 152  |
| Contracts . . . . .                           | 69   |
| Cooking, or processing . . . . .              | 44   |
| Cooling, after processing . . . . .           | 66   |
| Cordials . . . . .                            | 190  |
| Corn Acreage Contract . . . . .               | 69   |
| Corn Canning . . . . .                        | 88   |
| Corn, grades . . . . .                        | 90   |
| Corn, mechanical equipment . . . . .          | 89   |
| Corn, pickled . . . . .                       | 218  |
| Corn Seed Required to Plant an Acre . . . . . | 19   |
| Corn Standards . . . . .                      | 90   |
| Corned Beef . . . . .                         | 140  |
| Corned Fish . . . . .                         | 223  |
| Crabapple Jelly . . . . .                     | 186  |
| Crabapples, candied . . . . .                 | 169  |
| Crab Meat . . . . .                           | 225  |



|                                                          | Page |
|----------------------------------------------------------|------|
| Crab Meat, deviled.....                                  | 226  |
| Crabs, soft.....                                         | 226  |
| Cranberries .....                                        | 130  |
| Cranberry Jelly.....                                     | 186  |
| Cranberry Sauce .....                                    | 196  |
| Crating .....                                            | 69   |
| Cream of Asparagus Soup.....                             | 154  |
| Cream of Asparagus Soup, condensed.....                  | 154  |
| Cream of Celery Soup.....                                | 154  |
| Cream of Celery Soup, condensed.....                     | 154  |
| Cream of Pea Soup.....                                   | 155  |
| Cream of Pea Soup, condensed.....                        | 155  |
| Crushed Fruits for Soda Fountain.....                    | 181  |
| Crystallized Fruits .....                                | 171  |
| Crystallized Fruit Pie Filling.....                      | 195  |
| Cucumber Catsup.....                                     | 200  |
| Cucumbers, pickled .....                                 | 218  |
| Curacoa Cordial .....                                    | 190  |
| Currant Jelly .....                                      | 186  |
| Currants .....                                           | 130  |
| Curry Powder Mixture.....                                | 217  |
| Damson Jelly .....                                       | 186  |
| Damson Preserves .....                                   | 173  |
| Dandelion Greens .....                                   | 92   |
| Diagram of Model Cannery.....                            | 272  |
| Diamond Back Terrapin.....                               | 230  |
| Dill Pickles .....                                       | 218  |
| Dressing Rooms .....                                     | 23   |
| Dried Beans, varieties.....                              | 78   |
| Dried Fruit Preserves.....                               | 166  |
| Duck, canned .....                                       | 146  |
| Duties of Office and Factory Heads.....                  | 67   |
| Economy in the Use of Steam.....                         | 48   |
| Empty Can Storage .....                                  | 37   |
| Endive .....                                             | 92   |
| Engine, power plant.....                                 | 35   |
| Equipment, for hand work.....                            | 30   |
| Evaporated Milk .....                                    | 148  |
| Exhausting .....                                         | 42   |
| Extracts, flavoring .....                                | 209  |
| Factory Control of the Composition of Tomato Ketchup.... | 196  |
| Factory Requirements .....                               | 22   |
| F. I. D. No. 144.....                                    | 119  |
| Filling Cans or Jars.....                                | 62   |
| Figs .....                                               | 130  |
| Figs, candide .....                                      | 170  |

|                                                  | Page |
|--------------------------------------------------|------|
| Fish Canning . . . . .                           | 221  |
| Flavoring Extracts . . . . .                     | 209  |
| Floor Construction . . . . .                     | 22   |
| Floor Plans for Model Cannery . . . . .          | 272  |
| Food Laws . . . . .                              | 232  |
| Foreman's Contract . . . . .                     | 72   |
| Fresh Water Fish . . . . .                       | —    |
| Fruits in Brandy . . . . .                       | 181  |
| Fruit Butters . . . . .                          | 182  |
| Fruits, candied . . . . .                        | 168  |
| Fruits in Cordial . . . . .                      | 181  |
| Fruits, crystallized . . . . .                   | 171  |
| Fruit Canning . . . . .                          | 124  |
| Fruit Grading, California . . . . .              | 125  |
| Fruit Jam, American style . . . . .              | 180  |
| Fruit Juices . . . . .                           | 189  |
| Fruit Juice, grape . . . . .                     | 190  |
| Fruits, for pie fillings . . . . .               | 194  |
| Fruit Meringue Pie Filling . . . . .             | 194  |
| Fruits, preserved . . . . .                      | 162  |
| Fruits, preserved by hot process . . . . .       | 173  |
| Fruit Pudding . . . . .                          | 191  |
| Fruit Pulps for Marmalade . . . . .              | 167  |
| Fruits, spiced . . . . .                         | 181  |
| Fruit Standards, U. S. . . . .                   | 124  |
| Fruit, Sugar and Apple Juice Preserves . . . . . | 178  |
| Fruit Syrups . . . . .                           | 125  |
| Fruits and Sugar, preserved . . . . .            | 167  |
| Fruits, Wiesbaden process . . . . .              | 171  |
| "Future" Sales Contract . . . . .                | 71   |
| Game Birds, canned . . . . .                     | 147  |
| General Instructions . . . . .                   | 7    |
| Ginger, candied . . . . .                        | 170  |
| Ginger Extract . . . . .                         | 210  |
| Glass, processing in . . . . .                   | 62   |
| Goose, canned . . . . .                          | 146  |
| Gooseberries, canned . . . . .                   | 130  |
| Gooseberries, preserved . . . . .                | 173  |
| Grading Fruits in California . . . . .           | 125  |
| Grape Jams . . . . .                             | 181  |
| Grape Jelly . . . . .                            | 186  |
| Grape Juice . . . . .                            | 190  |
| Grapes, Canned . . . . .                         | 131  |
| Green Turtle . . . . .                           | 230  |
| Green Turtle Soup . . . . .                      | 155  |



|                                                                     | Page |
|---------------------------------------------------------------------|------|
| Greens, Dandelion . . . . .                                         | 92   |
| Guinea Fowls . . . . .                                              | 147  |
| Ham, potted . . . . .                                               | 144  |
| Hand Canning Plant . . . . .                                        | 30   |
| Help . . . . .                                                      | 21   |
| Herring Roe . . . . .                                               | 226  |
| History of Canning . . . . .                                        | 7    |
| Home-made Style Catsup . . . . .                                    | 204  |
| Home-made Style Preserves . . . . .                                 | 172  |
| Hominy Canning . . . . .                                            | 92   |
| Hominy Standards . . . . .                                          | 92   |
| Identification Marks on Cans . . . . .                              | 45   |
| Importance of Proper Processing . . . . .                           | 63   |
| Instructions, general . . . . .                                     | 7    |
| Instructive Articles:                                               |      |
| Report of Committee on Sanitation . . . . .                         | 25   |
| Scalding and Peeling Tomatoes . . . . .                             | 116  |
| Sterilization: Importance of proper processing . . . . .            | 63   |
| Waste Water in Canning Plants . . . . .                             | 40   |
| Investigation of the Uses of Steam in the Canning Factory . . . . . | 48   |
| Irish Stew . . . . .                                                | 142  |
| Jams . . . . .                                                      | 180  |
| Jellies . . . . .                                                   | 183  |
| Jelly, pure sugar . . . . .                                         | 186  |
| Jellying Acids . . . . .                                            | 183  |
| Julienne Soup . . . . .                                             | 155  |
| Julienne Soup, condensed . . . . .                                  | 155  |
| Kale, canned . . . . .                                              | 93   |
| Ketchup, cucumber . . . . .                                         | 200  |
| Ketchup, mushroom . . . . .                                         | 200  |
| Ketchup, oyster cocktail . . . . .                                  | 203  |
| Ketchup, tomato . . . . .                                           | 201  |
| Kidney Beans . . . . .                                              | 85   |
| Kraut, canned . . . . .                                             | 109  |
| Label Laws . . . . .                                                | —    |
| Labeling Cans . . . . .                                             | 37   |
| Labels for Cans . . . . .                                           | 37   |
| Labels, weights for . . . . .                                       | 237  |
| Labor Required . . . . .                                            | 21   |
| Lacquering of Cans . . . . .                                        | 68   |
| Laws, State and Federal . . . . .                                   | 233  |
| Lemon Extract . . . . .                                             | 210  |
| Lemon Meringue Pie Filling . . . . .                                | 195  |
| Lima Bean Canning . . . . .                                         | 84   |
| Lima Beans, dried and canned . . . . .                              | 85   |
| Lima Beans, pickled . . . . .                                       | 218  |

|                                     | Page |
|-------------------------------------|------|
| Lime Extract.....                   | 212  |
| Lobster, canned .....               | 227  |
| Macaroni Soup .....                 | 156  |
| Mace Extract.....                   | 213  |
| Macerated Preserves .....           | 172  |
| Machinery Used .....                | 23   |
| Making Brines .....                 | 74   |
| Maple Extract, imitation.....       | 213  |
| Market Possibilities .....          | 9    |
| Marking Every Can.....              | 45   |
| Marmalade, pulp for.....            | 167  |
| Marmalades .....                    | 181  |
| Maraschino Style Cherries.....      | 129  |
| Maraschino Cordial .....            | 190  |
| Measure or Labeling Laws.....       | 237  |
| Meat Jelly .....                    | 139  |
| Meats, canned .....                 | 139  |
| Meringue Pie Fillings.....          | 194  |
| Milk, evaporated or condensed.....  | 148  |
| Mince Meats .....                   | 192  |
| Mock Turtle Soup.....               | 156  |
| Mock Turtle Soup, condensed.....    | 157  |
| Model Canning Factory, diagram..... | 272  |
| Molasses or Sorghum.....            | 131  |
| Money Needed .....                  | 20   |
| Mould Prevention (in jellies).....  | 183  |
| Mulligatawny Soup .....             | 157  |
| Mulligatawny Soup, condensed.....   | 157  |
| Mushroom Catsup .....               | 200  |
| Mushrooms, canned .....             | 93   |
| Mutton, curried .....               | 142  |
| Mutton, roasted .....               | 141  |
| National Pure Food Laws.....        | 232  |
| Nectarines, candied.....            | 169  |
| Nectarines, preserved .....         | 173  |
| Nutmeg Extract.....                 | 213  |
| Okra, canned .....                  | 93   |
| Onions, pickled .....               | 218  |
| Open Bath Processing.....           | 45   |
| Orange Extract .....                | 213  |
| Orange Marmalade .....              | 181  |
| Orange Meringue Pie Fillings.....   | 194  |
| Orange Peel, candied.....           | 170  |
| Ox Tail Soup.....                   | 157  |
| Ox Tail Soup, condensed.....        | 158  |
| Oyster Cocktail (catsup).....       | 203  |



|                                              | Page |
|----------------------------------------------|------|
| Oysters . . . . .                            | 228  |
| Peach Butter . . . . .                       | 182  |
| Peach Flavor, imitation . . . . .            | 214  |
| Peach Jelly . . . . .                        | 187  |
| Peaches, canned . . . . .                    | 131  |
| Peaches, candied . . . . .                   | 169  |
| Peaches, preserved . . . . .                 | 174  |
| Pear Butter . . . . .                        | 182  |
| Pear Jelly . . . . .                         | 187  |
| Pears, canned . . . . .                      | 133  |
| Pears, candied . . . . .                     | 169  |
| Peas, for best growing localities . . . . .  | 100  |
| Peas, blanching . . . . .                    | 106  |
| Peas, a brief history of . . . . .           | 98   |
| Peas, the canning of . . . . .               | 97   |
| Peas, canned . . . . .                       | 94   |
| Pea Seed Required to Plant an Acre . . . . . | 19   |
| Peas, grading for quality . . . . .          | 102  |
| Peas, grading for size . . . . .             | 104  |
| Peas, hand picked . . . . .                  | 106  |
| Pea Soup . . . . .                           | 168  |
| Pea Soup, condensed . . . . .                | 168  |
| Pea Soup Stock . . . . .                     | 97   |
| Peas, standards . . . . .                    | 94   |
| Peas, washing . . . . .                      | 102  |
| Pectin . . . . .                             | 184  |
| Pectin Syrup . . . . .                       | 184  |
| Peeling Room in Power Plant . . . . .        | 34   |
| Peeling Tables, hand work . . . . .          | 33   |
| Peeling Tomatoes . . . . .                   | 116  |
| Peppermint Extract . . . . .                 | 214  |
| Peppers, pickled . . . . .                   | 219  |
| Pickled Beans . . . . .                      | 218  |
| Pickles, dill . . . . .                      | 219  |
| Pickles, mixed . . . . .                     | 219  |
| Pickles, sweet . . . . .                     | 220  |
| Pickling . . . . .                           | 218  |
| Pie Fillings . . . . .                       | 194  |
| Pie Filling, sweet potato . . . . .          | 113  |
| Pineapples, canned . . . . .                 | 133  |
| Pineapples, candied . . . . .                | 169  |
| Pineapple Flavor, imitation . . . . .        | 214  |
| Pineapple Jelly . . . . .                    | 187  |
| Pineapples, preserved . . . . .              | 174  |
| Pistache Flavor, imitation . . . . .         | 214  |
| Plan for Model Cannery . . . . .             | 272  |

|                                                | Page |
|------------------------------------------------|------|
| Plum Butter . . . . .                          | 182  |
| Plum Jelly . . . . .                           | 187  |
| Plum Pudding . . . . .                         | 190  |
| Plums, canned . . . . .                        | 136  |
| Plums, candied . . . . .                       | 169  |
| Plums, preserved . . . . .                     | 174  |
| Plums, spiced . . . . .                        | 181  |
| Poke Stalks . . . . .                          | 108  |
| Pork and Beans . . . . .                       | 80   |
| Pork and Beans, tomato sauce . . . . .         | 83   |
| Potatoes, sweet . . . . .                      | 112  |
| Potatoes, sweet, pulp for pies . . . . .       | 113  |
| Potted Fowl . . . . .                          | 145  |
| Potted Ham . . . . .                           | 144  |
| Potted Meats . . . . .                         | 143  |
| Potted Tongue . . . . .                        | 144  |
| Power Canning Plant . . . . .                  | 34   |
| Pre-Heating or Exhausting . . . . .            | 42   |
| Preserves, cold process . . . . .              | 172  |
| Preserves, compound . . . . .                  | 178  |
| Preserves, from dried fruits . . . . .         | 166  |
| Preserves, from fresh fruits . . . . .         | 162  |
| Preserves, home-made style . . . . .           | 172  |
| Preserves, hot process . . . . .               | 173  |
| Preserves, maceration process . . . . .        | 172  |
| Preserves of pure fruit and sugar . . . . .    | 167  |
| Preserves, sun-cooked style . . . . .          | 172  |
| Processed Beans, with pork . . . . .           | 80   |
| Processing (cooking) . . . . .                 | 44   |
| Processing, calcium method . . . . .           | 46   |
| Processing Glass Goods . . . . .               | 62   |
| Processing in Closed Kettles . . . . .         | 46   |
| Processing in Open Kettles . . . . .           | 45   |
| Processing, the importance of . . . . .        | 44   |
| Processing Times for Soups . . . . .           | 150  |
| Processing, water and steam combined . . . . . | 46   |
| Processor's Record . . . . .                   | 68   |
| Proper Use of Steam in Blanching . . . . .     | 50   |
| Puddings, canned . . . . .                     | 190  |
| Pulp, for marmalades . . . . .                 | 167  |
| Pulp, tomato . . . . .                         | 122  |
| Pumpkin, canned . . . . .                      | 108  |
| Pumpkin Butter . . . . .                       | 109  |
| Pumpkin, pickled . . . . .                     | 219  |
| Pumpkin-pie Filling . . . . .                  | 194  |
| Pumpkin-pie Filling, condensed . . . . .       | 194  |



|                                                         | Page |
|---------------------------------------------------------|------|
| Pumpkin Seed Required to Plant an Acre.....             | 19   |
| Pure Food Laws.....                                     | 232  |
| Pure Fruit and Sugar Preserves, maceration Process..... | 172  |
| Pure Fruit with Sugar.....                              | 167  |
| Pure Sugar Jellies.....                                 | 186  |
| Quahaugs, hard clams.....                               | 227  |
| Quince Jelly . . . . .                                  | 187  |
| Quinces, canned . . . . .                               | 136  |
| Quinces, candied. . . . .                               | 169  |
| Quinces, preserved . . . . .                            | 174  |
| Quinces, spiced . . . . .                               | 181  |
| Raspberries, canned . . . . .                           | 137  |
| Raspberries, candied . . . . .                          | 169  |
| Raspberry Extract, imitation.....                       | 215  |
| Raspberry Jelly . . . . .                               | 187  |
| Red Kidney Beans.....                                   | 85   |
| Red Legs, Terrapins.....                                | 230  |
| Requirements in the Factory.....                        | 22   |
| Rhubarb, canned . . . . .                               | 109  |
| Rice Pudding, canned . . . . .                          | 190  |
| Rice Soup, canned.....                                  | 158  |
| Rice Soup, condensed.....                               | 158  |
| Roast Fowl and Game Birds.....                          | 147  |
| Roasted Meats, canned.....                              | 141  |
| Roe of Herring, canned.....                             | 226  |
| Rose Extract.....                                       | 214  |
| Salad Dressing.....                                     | 205  |
| Sales Contract, Futures.....                            | 69   |
| Salmon, canned . . . . .                                | 224  |
| Salsify, canned . . . . .                               | 109  |
| Salt, used by canners.....                              | 42   |
| Satometer Table . . . . .                               | 77   |
| Salt Water Fish.....                                    | 223  |
| Sanitary Can Outfit.....                                | 30   |
| Sanitary Regulations . . . . .                          | 25   |
| Sanitation, report of a committee.....                  | 25   |
| Sardines, canned . . . . .                              | 221  |
| Sarsaparilla Extract.....                               | 215  |
| Sauce for Pork and Beans, canned.....                   | 81   |
| Sauce, Worcestershire . . . . .                         | 205  |
| Sauer Kraut, in barrels.....                            | 219  |
| Sauer Kraut, in cans.....                               | 109  |
| Scalder for Tomatoes, hand work.....                    | 33   |
| Scalding Tomatoes . . . . .                             | 115  |
| Scalding and Peeling Tomatoes.....                      | 116  |
| Seed Required to Plant an Acre.....                     | 19   |

|                                           | Page |
|-------------------------------------------|------|
| Shipping Conveniences.....                | 22   |
| Shrimp, canned . . . . .                  | 215  |
| Site for Factory.....                     | 22   |
| Sizes of Cans.....                        | 36   |
| Size, Shape and Color of Dried Beans..... | 78   |
| Small Fish in Bouillon.....               | 224  |
| Small Fish in Oil.....                    | 224  |
| Snapping Turtle, canned.....              | —    |
| Soda Fountain Fruits.....                 | 181  |
| Soft Crabs, canned.....                   | —    |
| Sorghum or Molasses, canned.....          | 131  |
| Soups, canned.....                        | 149  |
| Soups, condensed . . . . .                | 149  |
| Soup Spice Mixtures'.....                 | 217  |
| Soup Stock . . . . .                      | 149  |
| Soup Stock, peas.....                     | 97   |
| Spearmint Extract.....                    | 215  |
| Spaghetti, canned.....                    | 111  |
| Spiced Fruits . . . . .                   | 181  |
| Spiced Mixtures . . . . .                 | 217  |
| Spiced Vinegar . . . . .                  | 207  |
| Spinach, canned . . . . .                 | 111  |
| Sprouts, Brussels . . . . .               | 87   |
| Squash, canned . . . . .                  | 112  |
| Stamping Cans . . . . .                   | 45   |
| Standards of U. S., fruits.....           | 124  |
| Standards of U. S., jams.....             | 180  |
| Standards of U. S., jellies.....          | 183  |
| Standards of U. S., preserves.....        | 162  |
| Standards' of U. S., vegetables.....      | 74   |
| Standards of U. S., F. I. D. 144.....     | 119  |
| Sterilizing Goods, above sea level.....   | 47   |
| Sterilizing Point . . . . .               | 45   |
| Stewed Meats, canned.....                 | 141  |
| Stewed Snapping Turtle.....               | 230  |
| Storage of Empty Cans.....                | 37   |
| Strawberries, canned . . . . .            | 138  |
| Strawberries, candied . . . . .           | 170  |
| Strawberry Extract.....                   | 215  |
| Strawberries, preserved . . . . .         | 174  |
| Strawberry Jam . . . . .                  | 180  |
| Strawberry Jelly . . . . .                | 187  |
| String Beans, canned . . . . .            | 85   |
| String Beans, pickled.....                | 218  |
| Succotash . . . . .                       | 112  |
| Sugar in Canning Vegetables.....          | 39   |



|                                                                  | Page |
|------------------------------------------------------------------|------|
| Sugar and Fruit Preserves.....                                   | 167  |
| Sugar Jellies . . . . .                                          | 186  |
| Sun Cooked Preserves.....                                        | 172  |
| Superintendent's Contract . . . . .                              | 72   |
| Superintendent-Processor's Duties . . . . .                      | 67   |
| Supplies, buying, etc. . . . .                                   | 242  |
| Supplies necessary . . . . .                                     | 36   |
| Sweet Pickles . . . . .                                          | 220  |
| Sweet Potatoes, canned . . . . .                                 | 112  |
| Sweet Potato Pulp for pies.....                                  | 113  |
| Syrup or Molasses, canned.....                                   | 131  |
| Syrups for Fruits.....                                           | 125  |
| Terrapin, diamond-back, etc.....                                 | 230  |
| Thermometer Testing . . . . .                                    | 37   |
| Tomato Acreage Contract.....                                     | 69   |
| Tomato Butter, canned.....                                       | 182  |
| Tomato Cannery, a clean one.....                                 | 115  |
| Tomato Catsup . . . . .                                          | 196  |
| Tomato Catsup, fancy sweet.....                                  | 202  |
| Tomato Catsup, home-made style.....                              | 204  |
| Tomato Catsup, method of handling.....                           | 201  |
| Tomato Juice, condensed . . . . .                                | 123  |
| Tomato Peeling . . . . .                                         | 116  |
| Tomato Pulp . . . . .                                            | 121  |
| Tomato Pulp, concentrated . . . . .                              | 122  |
| Tomato Pulp, medium grade . . . . .                              | 123  |
| Tomato Pulp, whole fruit.....                                    | 121  |
| Tomato Sauce, for beans.....                                     | 81   |
| Tomato Scalding, hand work.....                                  | 33   |
| Tomato Scalding . . . . .                                        | 115  |
| Tomato Scalding and Peeling. . . . .                             | 116  |
| Tomato Soup, canned . . . . .                                    | 158  |
| Tomato Soup, condensed.....                                      | 159  |
| Tomato Standards . . . . .                                       | 119  |
| Tomatoes, a clean cannery.....                                   | 115  |
| Tomatoes, candied . . . . .                                      | 170  |
| Tomatoes, composition of . . . . .                               | 121  |
| Tomatoes, general remarks regarding growing and canning. . . . . | 113  |
| Tomatoes, whole canned.....                                      | 121  |
| Tongue, beef, pig, sheep.....                                    | 143  |
| Tongue, potted . . . . .                                         | 144  |
| Transportation Facilities. . . . .                               | 22   |
| Turkey, boned . . . . .                                          | 146  |
| Turkey in Jelly.....                                             | 146  |
| Turkey, potted . . . . .                                         | 145  |
| Turkey, roasted . . . . .                                        | 146  |

|                                                | Page |
|------------------------------------------------|------|
| Turnips, canned . . . . .                      | 123  |
| Turnip Tops, canned . . . . .                  | 123  |
| Turtle, canned . . . . .                       | 230  |
| Turtle, snapping . . . . .                     | 230  |
| Turtle, stewed, snapping . . . . .             | 230  |
| Turtle Soup, canned . . . . .                  | 155  |
| Turtle Soup, mock . . . . .                    | 156  |
| Turtle Soup, mock, condensed . . . . .         | 157  |
| U. S. Food Standards:                          |      |
| Fruit . . . . .                                | 124  |
| Jams . . . . .                                 | 180  |
| Jellies . . . . .                              | 183  |
| Preserves . . . . .                            | 162  |
| Vegetables . . . . .                           | 74   |
| F. I. D. No. 144 . . . . .                     | 119  |
| Undesirable Varieties of Dried Beans . . . . . | 80   |
| Vanilla Extract . . . . .                      | 215  |
| Veal, jellied . . . . .                        | 142  |
| Veal Loaf, canned . . . . .                    | 142  |
| Veal Roast, canned . . . . .                   | 142  |
| Vegetable Canning . . . . .                    | 74   |
| Vegetable Soup, canned . . . . .               | 160  |
| Vegetable Soup, condensed . . . . .            | 160  |
| Vegetable Standards . . . . .                  | 74   |
| Venison, roasted . . . . .                     | 143  |
| Venison, canned . . . . .                      | 143  |
| Vermicelli Soup . . . . .                      | 159  |
| Vermicelli Soup, condensed . . . . .           | 159  |
| Vinegar, spiced . . . . .                      | 207  |
| Water and Steam Processing . . . . .           | 62   |
| Water Supply Necessary . . . . .               | 20   |
| Weight Laws . . . . .                          | 237  |
| Weight for Labels . . . . .                    | 240  |
| Wild Cherry Extract, imitation . . . . .       | 217  |
| Wiesbaden Fruits . . . . .                     | 171  |
| Worcestershire Sauce . . . . .                 | 205  |
| Workers, their condition . . . . .             | 24   |



“The Canning Trade” also publishes at Baltimore, Md., the following other books on canning:

|                                          |        |
|------------------------------------------|--------|
| “A History of the Canning Industry”..... | \$1.00 |
| “How to Buy and Sell Canned Foods”.....  | \$2.15 |
| “Almanac of the Canning Trade”.....      | \$1.00 |

Almanac is sent free with a subscription to “The Canning Trade” (weekly), \$3.00 per year.





# Advertisements

---

---



CONSULT THESE SUPPLY HOUSES  
FOR YOUR REQUIREMENTS





# **TIN CANS FIBRE**

**PLAIN OR DECORATED**



## **American Can Company**

NEW YORK

SAN FRANCISCO

CHICAGO

ROCHESTER, N. Y.

BALTIMORE

PORTLAND, ORE.

HAMILTON, ONT. CANADA

# PEA VINER

Twenty new concerns going into the packing of peas for 1919, have thoroughly investigated the merits of the Viners and nineteen of them have signed with us for five years.

Do you want any better evidence as to which Viner to use?

## CHISHOLM-SCOTT CO.

71 E. State St.

Columbus, Ohio

Manufacturers and Lessors of

**VINERS, FEEDERS AND UNDER-CARRIER SEPARATORS**

# FIDELITY CAN CO.

600 TO 610 S. CAROLINE STREET

BALTIMORE, MD.



Cans for Food Products  
Our Specialty



WE CAN STRAIGHTEN OUT THE KINKS FOR THE  
SMALL CANNER



# WORLD CAN LABELER

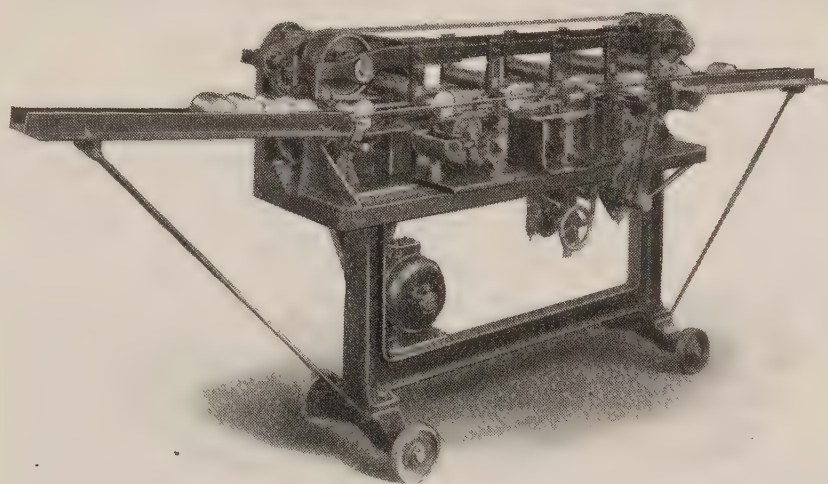

**An up-to-the minute machine, made by manufacturers of broad experience in various kinds of labeling problems**

Quickly adjustable to different sizes.

Only one kind of gum needed.

No dripping of gum—No wasted labels.

Speedy and durable—Mechanically correct.

**YOU SHOULD KNOW ALL ABOUT IT**

**SEND FOR PARTICULARS**

## **Economic Machinery Co.**

**Worcester, Mass.**

**Makers of the well-known World Labeler for Bottles,  
Jars, Tumblers and other Packages**

## CANNING FACTORY MACHINERY

TOMATO WASHERS                      WASHERS AND SCALDERS

ROTARY MEASURE TOMATO FILLERS

ROTARY PEA AND BEAN FILLERS

EXHAUSTERS

CORN SHAKERS

CORN COOKER-FILLERS      ELECTRIC PROCESS CLOCKS

PLUNGER FILLERS for Condensed Milk, Jams, Jellies,  
Apple Butter, Pastes, Pulp, Molasses, Syrups, Vinegar, etc.

*WRITE FOR CATALOGUE*

**AYARS MACHINE COMPANY**

Salem, New Jersey

## IMPROVED STEEL PROCESS KETTLE

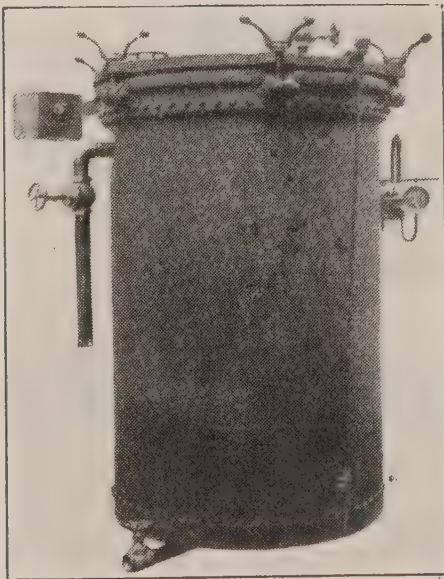

Manufactured to hold 800, 1,000 and 1,200 2-lb. cans. Conceded to be the best; hundreds in use. Double thermometer pocket rivited to each kettle. Constructed so as to use either water, dry steam, or open bath process.

**ZASTROW MACHINE COMPANY, Inc.**  
1404-1410 THAMES STREET                      BALTIMORE, MD.



## THE STANDARD CANNED GOODS BOX OF THE FUTURE

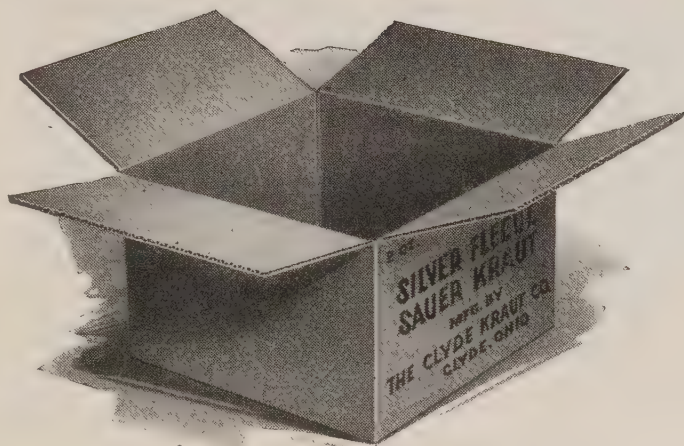

Nearly five million sold in 1918 without one case of failure.

Made especially for canned foods and sealed on the press we supply at nominal rental, they carry safer than any other style of package in actual tests.

## H. & D. CORRUGATED FIBRE SHIPPING BOXES

save a good percentage in first cost and 90% of your storage room—no more work to carry a half-dozen than to move one ordinary box. They lighten the labor and speed up the work of packing.

They cushion their contents and absorb internal moisture—no split boxes or rust spotted cans where they are used.

Best of references and endorsements from actual users.



*Write for Cannery Booklet*

**THE HINDE & DAUCH PAPER CO.**

806 Water Street

SANDUSKY, OHIO

Canadian Trade Address Toronto

# TIN PLATE

## As To Our Capacity

If our capacity were as small as the capacity of many other plants, we would not be able to equal our present immense output of high grade tin plate.

If our capacity were as large as the capacities of some other plants, we would not be able to give every order the personal attention that it now receives. We figure that our mill is "*the happy medium.*" While it has a large output, it is not so large but that our Superintendent and Heads of Departments can keep constantly in touch with every process through which every order passes.

### CARNAHAN TIN PLATE & SHEET CO.

Main Office and Plant

3902 Woolworth Bldg.

EASTERN OFFICE

CANTON, OHIO

New York, N. Y.

## STEEL STOOLS AND FURNITURE FOR CANNERS

Otsteel stools have been adopted as standard equipment in many of the largest canning factories of the country, Otsteel furniture being adaptable to individual requirements and usually portable. Has a real place in efficient canning factories.



No. 4

All steel canner's stool, having concave shaped seat 13 inch in diameter.

Write for descriptive

net price bulletins.

**Angle Steel Stool Company**

**Otsego, Michigan**



No. 2418-D

One of our portable trucks.



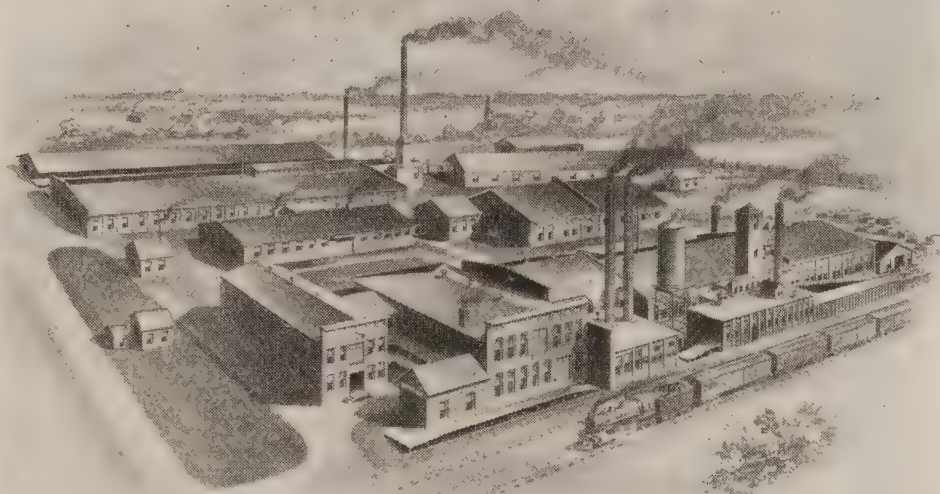

## SPRAGUE WORKS

The Home Of The Sign Of Quality

# Builders of Complete Equipment For Canning and Preserving Plants

The only manufacturers who are prepared to supply your requirements in canning factory machinery, complete in every detail, backed up by thirty years of experience and a money back guarantee of satisfaction.

## SPRAGUE CANNING MACHINERY COMPANY

Factory: Hoopeston, Ill.    General Offices: Chicago, Ill.

Eastern Branch:  
Sheppard Supply & Equipment Co.  
37 S. Charles Street  
Baltimore, Md.

Western Agents:  
Premier Machinery Co.  
16 California Street  
San Francisco, Cal.

# CANNING MACHINERY

FOR

**Fruits, Vegetables, Oysters, Etc.**

**Tomato Pulp Machinery**

A GENERAL CANNERS' SUPPLY HOUSE

**A. K. Robins & Co. Baltimore, Md.**

## LIVINGSTON SANITARY TOMATO WASHER

Fourteen Factories T. A. Snider Catsup Co.  
Equipped With These Washers

### BETTER BE SURE THAN SORRY

Microscopic counts on Ketchup and Pulp finished after passing through this Washer show that it removes practically all of the material forming a high mold, yeast and bacteria count as well as the grit, and at the same time not injuring the healthy, clean meat of the tomato.

**You owe it to yourself to investigate. Write us today. Now.**

## SUPERIOR BOILER WORKS

**Marion, Indiana**

**Eastern Agent**

**S. O. RANDALL'S SON  
BALTIMORE, MD.**

**Central Agent**

**F. H. LANGSENKAMP  
INDIANAPOLIS**



# Sanitary Cans AND Closing Machines

First of all, Heekin cans are safe.

Canners need have no worry regarding the wisdom of using cans that are as time-tested as are Heekin's.

From the standpoint of our 18 years of manufacturing experience and from the standpoint of the tests to which these cans have been subjected, they are absolutely SAFE.

Consider also the quality of metal used.

Heekin service is prompt, efficient, satisfying.

*Write for our Interesting Prices Today*

## The Heekin Can Co.

Culvert and New Sts.

Cincinnati, Ohio

*"Heekin Can Since 1901"*

# Ar-Cane Liquid Sugar

**100% CANE SUGAR      30% SWEETER  
7% CHEAPER**

Cannot Crystallize, Sour or Ferment. Does not contain any Foreign Sweetening Substitute; Made from 100% Sugar.

Formula: One gallon Ar-Cane equal in sweetening power to 10  $\frac{4}{10}$  lbs. Sugar.

*Let us send you a Sample*

**ARCHBOLD MANUFACTURING CORPORATION**  
344 Blossom Road      ROCHESTER, N. Y.

**We Build METAL AND WOOD TANKS, for Cannery and Packers**

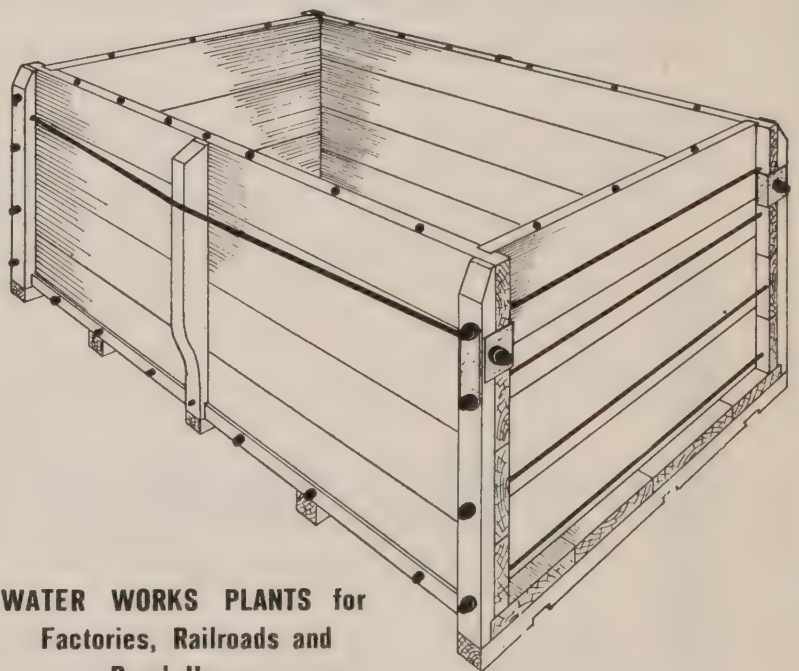

**WATER WORKS PLANTS for  
Factories, Railroads and  
Rural Homes**

**THE BALTIMORE COOPERAGE COMPANY**

∴

**BALTIMORE, MD.**



**“THE  
KNAPP  
WAY”**

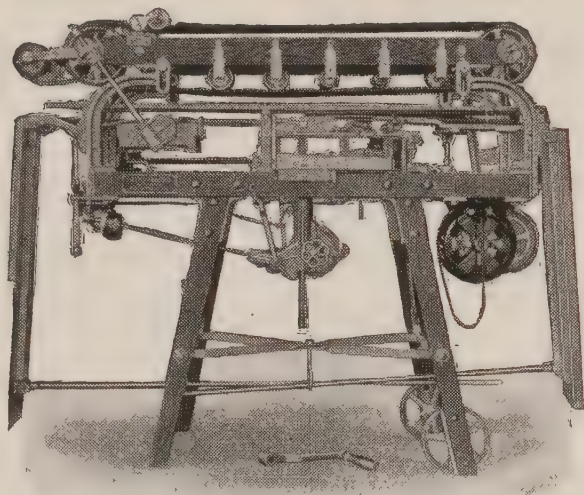

of Labeling and Boxing cans is positive, practical, and speedy.

The Knapp Labeler is automatic; always ready for instant use.

When labels are nearly used, the cans are automatically stopped until more labels are inserted.

Normal speed of 50,000 cans in ten hours. Runs 100,000 if needed.

We guarantee the Knapp Labeler to give satisfaction, or no pay.

Write us for terms, exchange deal, or rental proposition.

**THE FRED H. KNAPP CO.**

**BALTIMORE, MD., U. S. A.**

## What's The Use—

Knowing how to produce the goods properly—as this book tells you—if you do not know how to market them at a profit?

How can you market them best unless you keep well informed in your business?

The way to keep constantly and reliably informed is to read

### THE CANNING TRADE

The Journal of the Canned Foods Industry

Every week. It reaches your desk on Monday Mornings, with all the news of this industry—and costs but \$3.00 per year in U. S. A., \$4.00 in Canada, or \$5.00 in foreign countries.

And a copy of the yearly Almanac of The Canning Industry goes with each Subscription.

THE CANNING TRADE

BALTIMORE, MD.



## HAMILTON STEAM-JACKETED KETTLES

are made in a shop which understands the requirements of the canner and preserver through long experience.

Practical, durable, well finished Copper Kettles, made of heavy Copper and each rated size is of full capacity. Thoroughly tested to pass all city and state requirements.

We make kettles of every description for the Cannery, Preservers, and Condiment Makers-such as Stationary Kettles with and without Stirrers, Large and Small Tilting Kettles with and without Stirrers. Also furnish these Kettles when desired with loose or hinged covers.

**LET US FIGURE ON YOUR WANTS**

**HAMILTON COPPER & BRASS WORKS**

**HAMILTON, OHIO**

*Have Been Making Kettles Since 1869*

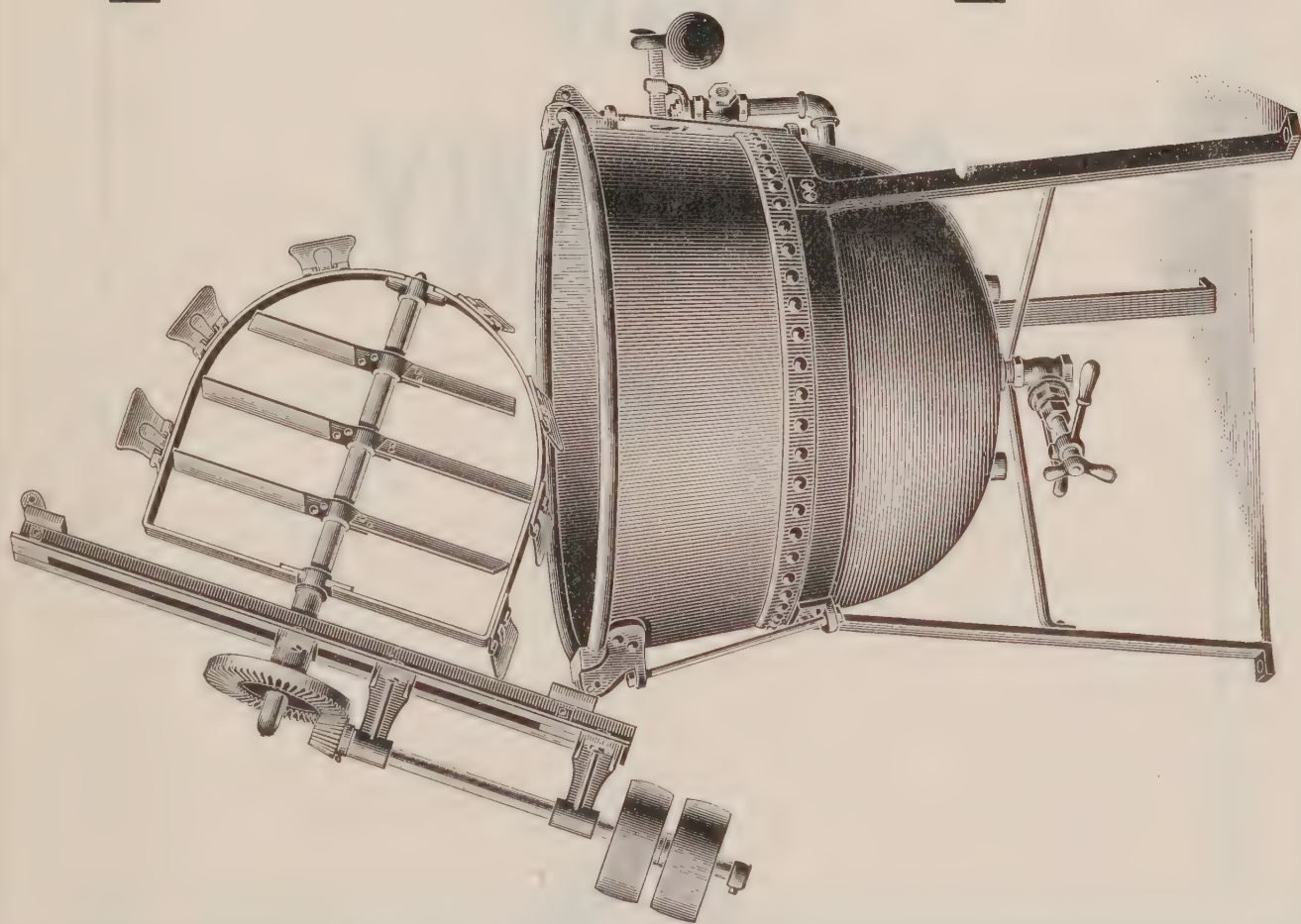

**CONTINENTAL  
CAN  
COMPANY  
INC.**











RAILROAD SIDING ENTIRE LENGTH OF BUILDING

|                          |     |     |     |     |     |     |     |     |     |     |     |
|--------------------------|-----|-----|-----|-----|-----|-----|-----|-----|-----|-----|-----|
| 1                        | 2   | 3   | 4   | 5   | 6   | 7   | 8   | 9   | 10  | 11  | 12  |
| 13                       | 14  | 15  | 16  | 17  | 18  | 19  | 20  | 21  | 22  | 23  | 24  |
| 25                       | 26  | 27  | 28  | 29  | 30  | 31  | 32  | 33  | 34  | 35  | 36  |
| 37                       | 38  | 39  | 40  | 41  | 42  | 43  | 44  | 45  | 46  | 47  | 48  |
| 49                       | 50  | 51  | 52  | 53  | 54  | 55  | 56  | 57  | 58  | 59  | 60  |
| 61                       | 62  | 63  | 64  | 65  | 66  | 67  | 68  | 69  | 70  | 71  | 72  |
| 73                       | 74  | 75  | 76  | 77  | 78  | 79  | 80  | 81  | 82  | 83  | 84  |
| 85                       | 86  | 87  | 88  | 89  | 90  | 91  | 92  | 93  | 94  | 95  | 96  |
| 97                       | 98  | 99  | 100 | 101 | 102 | 103 | 104 | 105 | 106 | 107 | 108 |
| 109                      | 110 | 111 | 112 | 113 | 114 | 115 | 116 | 117 | 118 | 119 | 120 |
| 121                      | 122 | 123 | 124 | 125 | 126 | 127 | 128 | 129 | 130 | 131 | 132 |
| 133                      | 134 | 135 | 136 | 137 | 138 | 139 | 140 | 141 | 142 | 143 | 144 |
| 145                      | 146 | 147 | 148 | 149 | 150 | 151 | 152 | 153 | 154 | 155 | 156 |
| 157                      | 158 | 159 | 160 | 161 | 162 | 163 | 164 | 165 | 166 | 167 | 168 |
| 169                      | 170 | 171 | 172 | 173 | 174 | 175 | 176 | 177 | 178 | 179 | 180 |
| 181                      | 182 | 183 | 184 | 185 | 186 | 187 | 188 | 189 | 190 | 191 | 192 |
| 193                      | 194 | 195 | 196 | 197 | 198 | 199 | 200 | 201 | 202 | 203 | 204 |
| 205                      | 206 | 207 | 208 | 209 | 210 | 211 | 212 | 213 | 214 | 215 | 216 |
| 217                      | 218 | 219 | 220 | 221 | 222 | 223 | 224 | 225 | 226 | 227 | 228 |
| 229                      | 230 | 231 | 232 | 233 | 234 | 235 | 236 | 237 | 238 | 239 | 240 |
| 241                      | 242 | 243 | 244 | 245 | 246 | 247 | 248 | 249 | 250 | 251 | 252 |
| 253                      | 254 | 255 | 256 | 257 | 258 | 259 | 260 | 261 | 262 | 263 |     |
| 265                      | 266 | 267 | 268 | 269 | 270 | 271 | 272 | 273 | 274 |     |     |
| 277                      | 278 | 279 | 280 | 281 | 282 | 283 | 284 | 285 | 286 |     |     |
| RECEIVING CLERK'S OFFICE | 291 | 292 | 293 | 294 | 295 | 296 | 297 | 298 |     |     |     |
|                          | 303 | 304 | 305 | 306 | 307 | 308 | 309 | 310 |     |     |     |

BOILER HOUSE

COAL BUNKERS

BOILER HOUSE AND COAL BUNKERS ON OTHER SIDE OF TRACK

24'x48' - 2 STORY  
GROUND FLOOR FOR ENGINE, DYNAMO, PUMP, MACHINE SHOP AND STORAGE FOR UNUSED MACHINES

SECOND STORY - CAN STORAGE - WITH SHOOTS DIRECT TO CAN FILLING MACHINES AND PACKING TABLES

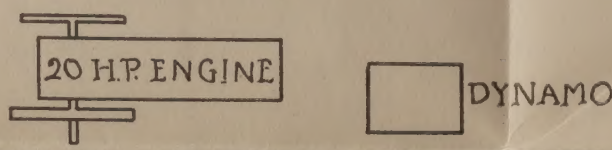

RETORTS - WITH TRAVELLING HOIST

COOLING TANK 4'x68' - CONTINUOUS CONVEYOR OR TRAVELLER

WAREHOUSE 104' BY ANY DESIRED WIDTH

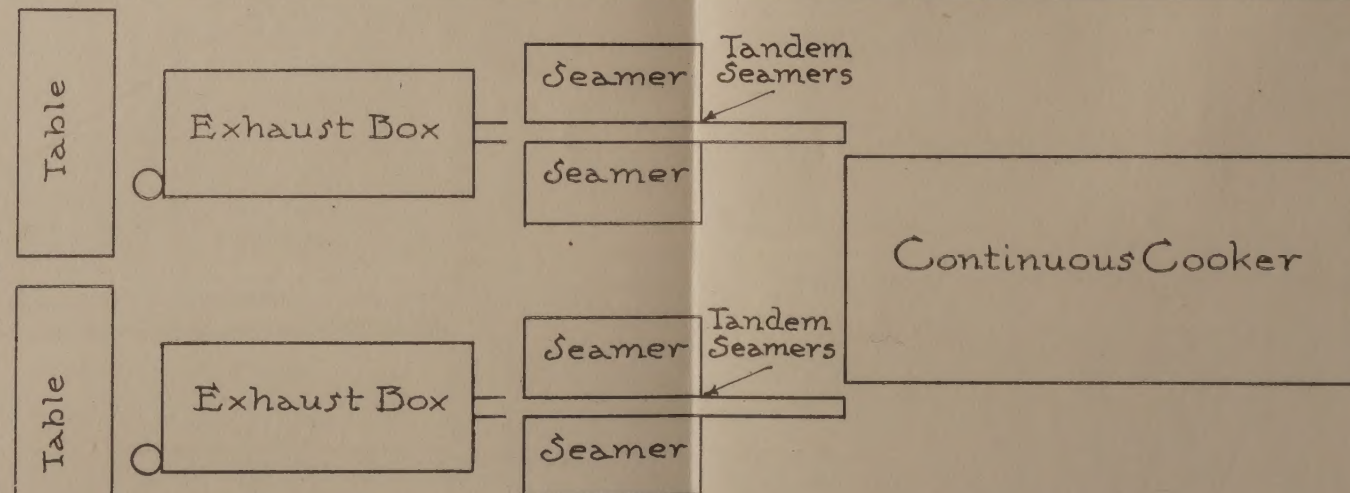

HAND CAPPING TABLE 3'x16'    CONTINUOUS STEAM EXHAUST 2'6"x24"    TIPPING TABLE    CONVEYOR PROCESS TANK OR STEAM STERILIZER

# Model Canning Factory.

ADAPTED TO ALL PURPOSES.

NOTE: Drawn to Scale of 1/8 inch to 1 Foot.

- Peeling Room 48 x 104 FT.
- Seamer Room 30 x 64 FT.
- Process Room 14 x 80 FT.
- Blocks in Peeling Room 4x4 FT.

3-100 GAL COPPER KETTLES











